



ASSEMBLY INSTRUCTIONS

READ BEFORE STARTING ASSEMBLY

TOOLS: In addition to the parts supplied, you will need the following tools to assemble and finish this kit. **DO NOT** use model airplane glue for building flying model rockets.



SKY DEVIL

Centuri

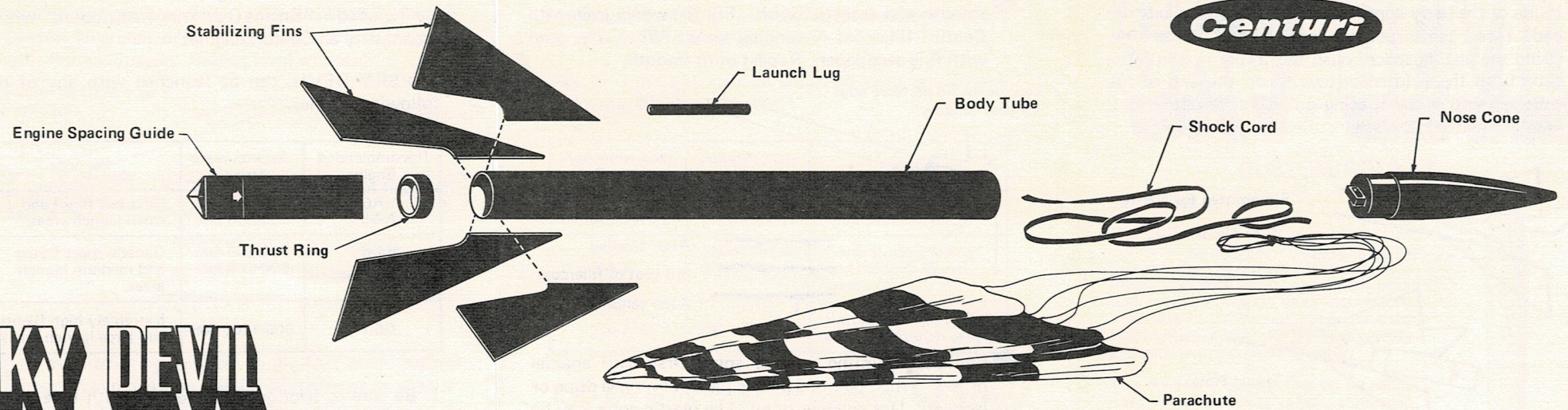

THESE ARE THE DIFFERENT STYLES TO CHOOSE FROM:

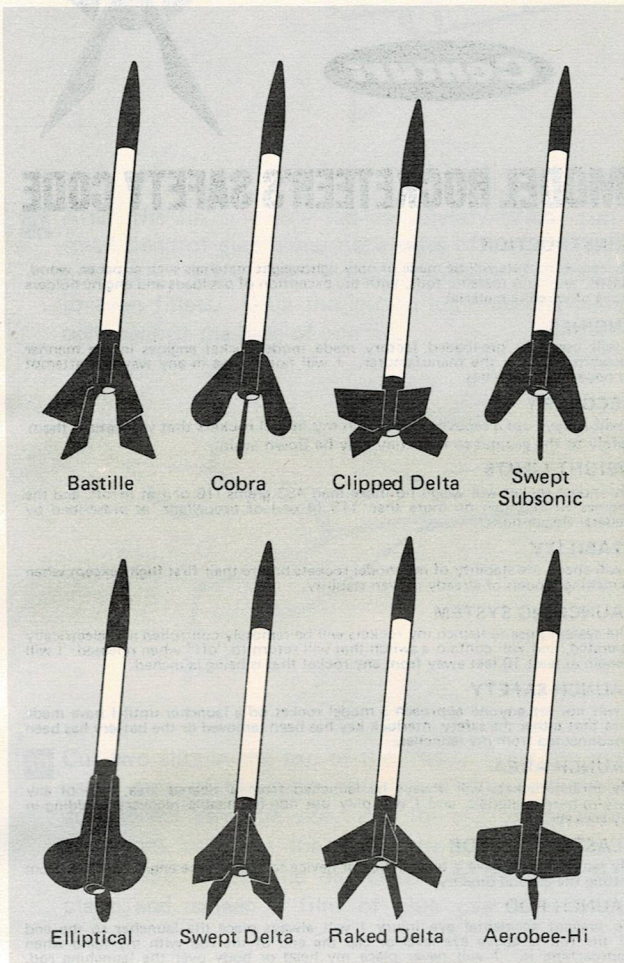

B. Remove the chrome spec-plate from the package label before starting assembly. Cut out the pattern neatly, using a ruler and modeling knife.

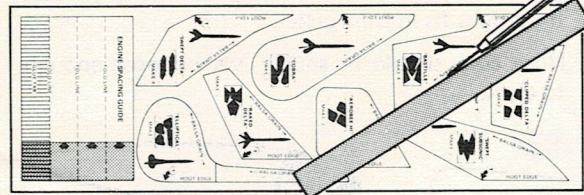

C. Lay the pattern down on the sheet of balsa wood and trace around it lightly (with a pencil or ball point pen) to achieve the fin "layout" shown in miniature on the fin pattern.

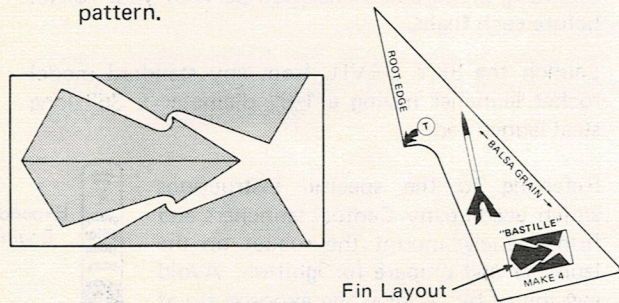

D. Check your drawing on the balsa sheet. Do you have the required number of fins? Are the leading edges parallel with the grain? If you made a mistake just turn the sheet over and try again!

E. Cut out the fins neatly, using a sharp modeling knife and ruler. Line fins together against each other, and run them over fine sandpaper to form neat, crisp edges.

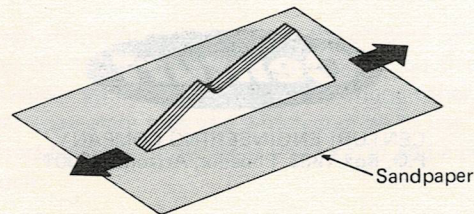

2 To draw guide lines for neatly gluing on fins: Stand the body tube on its fin guide and mark each position on the tube. **NOTE:** You must use the required number of fins for the chosen fin shape, for proper flight stability.

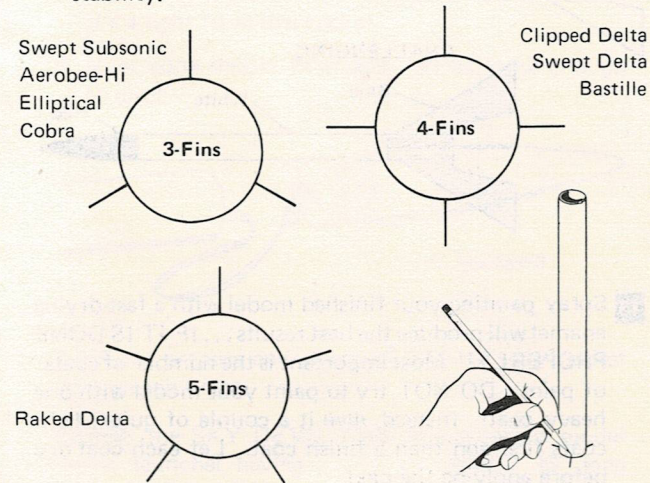

3 Find a convenient groove or channel, such as a door jamb or partially open drawer. Extend the marks into straight guide lines the length of the tube.

4 Apply glue to the root edge of a fin and position it along line drawn on the body tube. Remove, allow to dry, apply glue again, and re-position. Allow to dry, standing vertically, and check alignment visually.

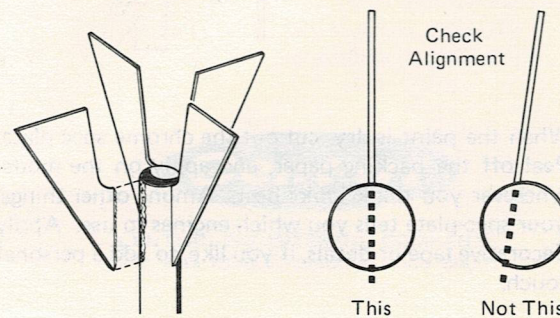

5 Pass one end of the shock cord through the nose cone eyelet, and tie a firm knot with about 2" of shock cord extending free past the knot.

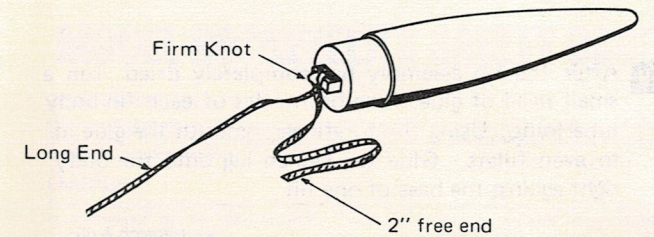

6 Tie the free piece of shock cord firmly thru the shroud line loop in the assembled parachute.

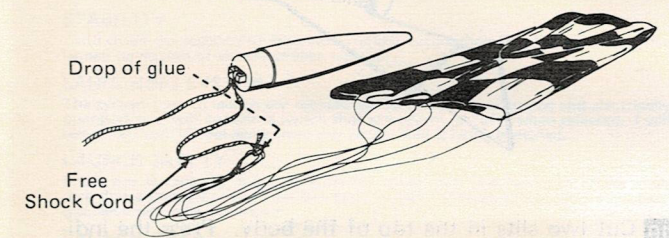

7 Cut out the printed engine spacing guide from the backside of package label. Run a pencil (or knife) along the fold lines to form creases. Fold the guide into a neat triangular shape - joining with glue or tape.

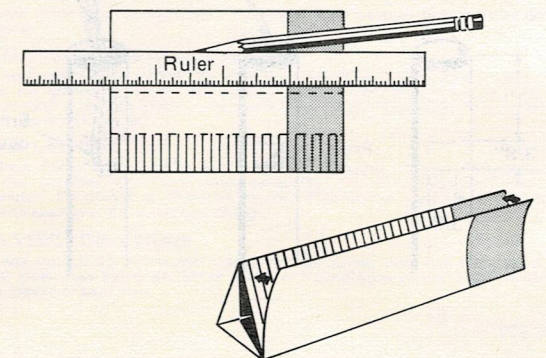

1 The first step is to choose the fin shape you want.

A. Look over the fin patterns on the backside of the package label.

We'll use this fin just as an example, in our instructions.

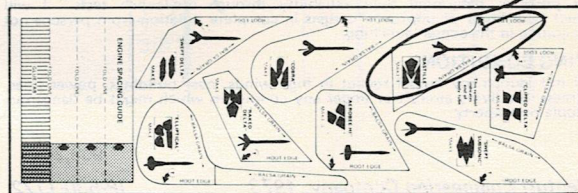

ASSEMBLY INSTRUCTIONS

READ BEFORE STARTING ASSEMBLY

TOOLS: In addition to the parts supplied, you will need the following tools to assemble and finish this kit. **DO NOT** use model airplane glue for building flying model rockets.

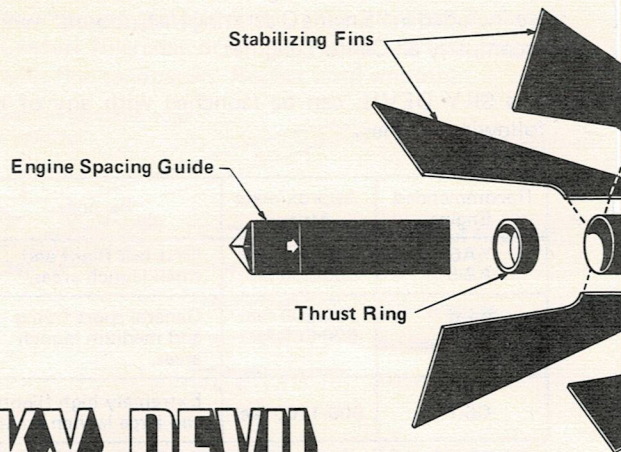

SKY DEVIL

THESE ARE THE DIFFERENT STYLES TO CHOOSE FROM:

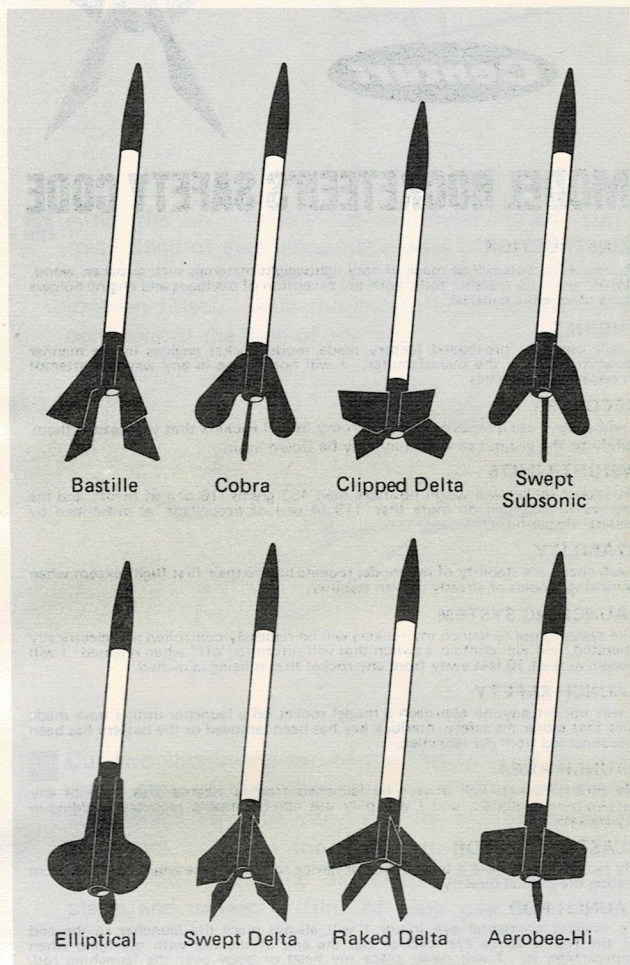

B. Remove the chrome spec-plate from the package label before starting assembly. Cut out the pattern neatly, using a ruler and modeling knife.

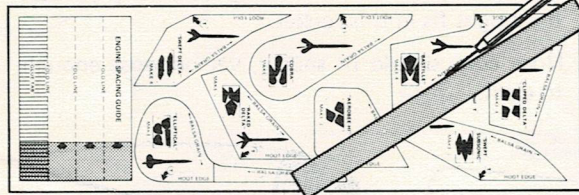

C. Lay the pattern down on the sheet of balsa wood and trace around it lightly (with a pencil or ball point pen) to achieve the fin "layout" shown in miniature on the fin pattern.

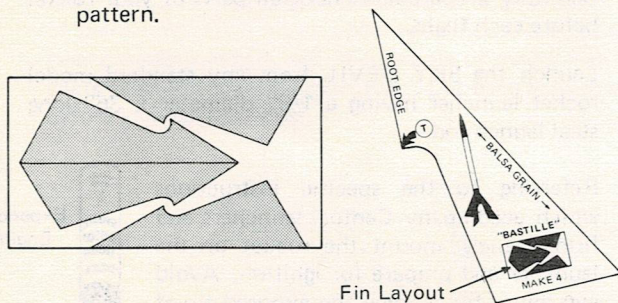

D. Check your drawing on the balsa sheet. Do you have the required number of fins? Are the leading edges parallel with the grain? If you made a mistake just turn the sheet over and try again!

E. Cut out the fins neatly, using a sharp modeling knife and ruler. Line fins together against each other, and run them over fine sandpaper to form neat, crisp edges.

1 The first step is to choose the fin shape you want.

A. Look over the fin patterns on the backside of the package label.

We'll use this fin just as an example, in our instructions.

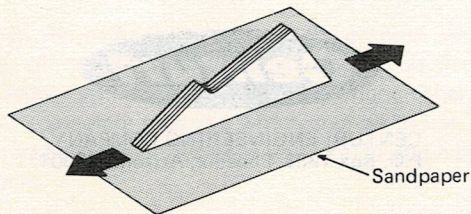
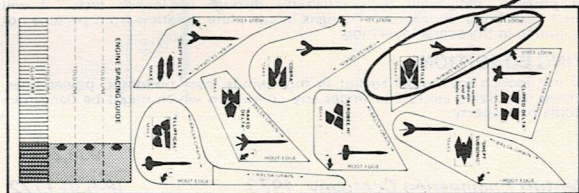

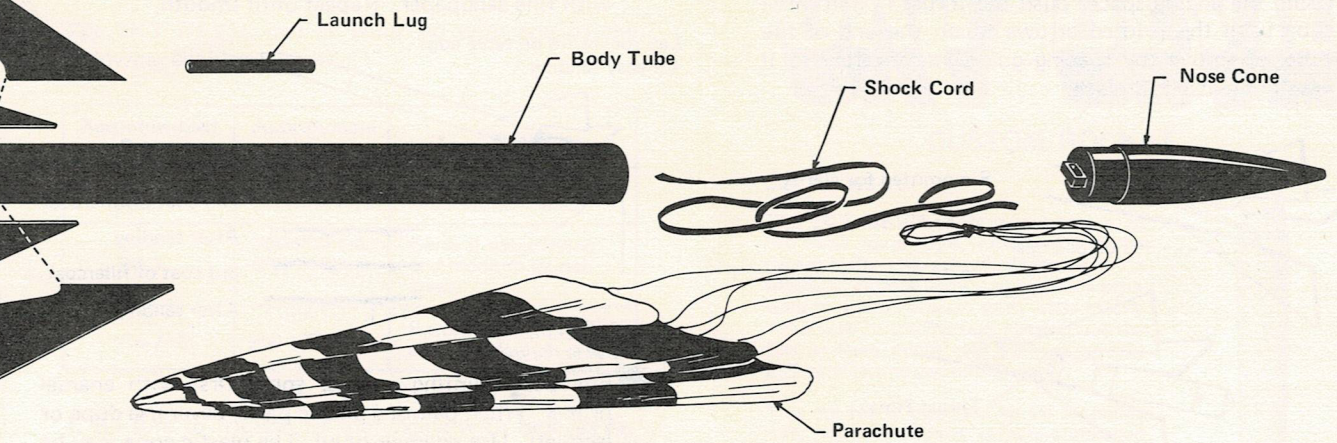

2 To draw guide lines for neatly gluing on fins: Stand the body tube on its fin guide and mark each position on the tube. **NOTE:** You must use the required number of fins for the chosen fin shape, for proper flight stability.

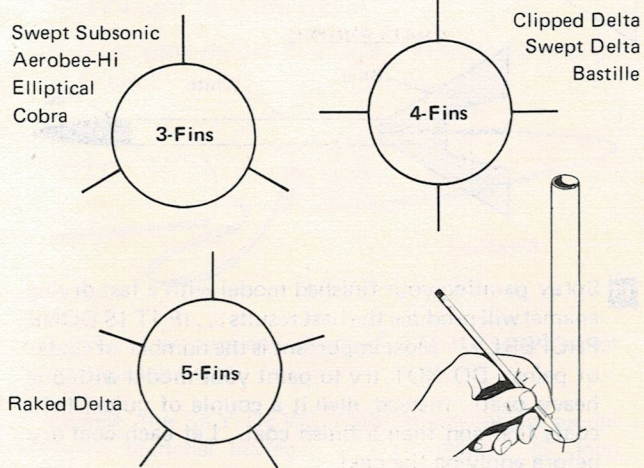

3 Find a convenient groove or channel, such as a door jamb or partially open drawer. Extend the marks into straight guide lines the length of the tube.

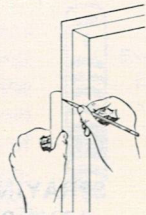

4 Apply glue to the root edge of a fin and position it along line drawn on the body tube. Remove, allow to dry, apply glue again, and re-position. Allow to dry, standing vertically, and check alignment visually.

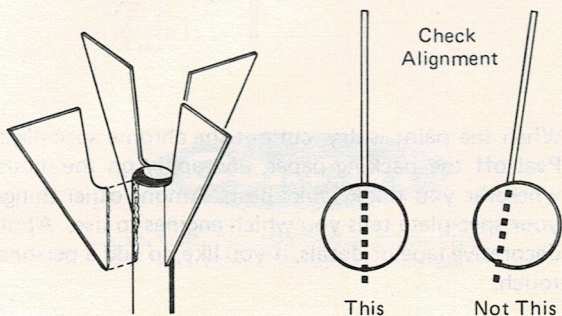

5 Pass one end of the shock cord through the nose cone eyelet, and tie a firm knot with about 2" of shock cord extending free past the knot.

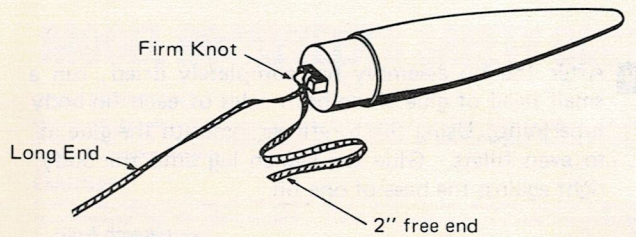

6 Tie the free piece of shock cord firmly thru the shroud line loop in the assembled parachute.

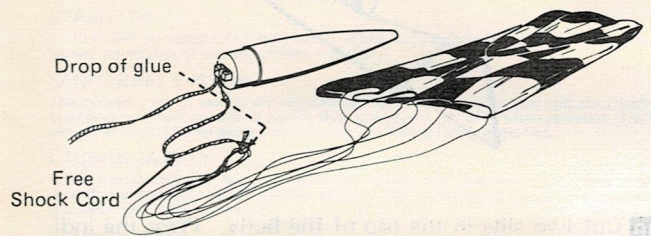

7 Cut out the printed engine spacing guide from the backside of package label. Run a pencil (or knife) along the fold lines to form creases. Fold the guide into a neat triangular shape - joining with glue or tape.

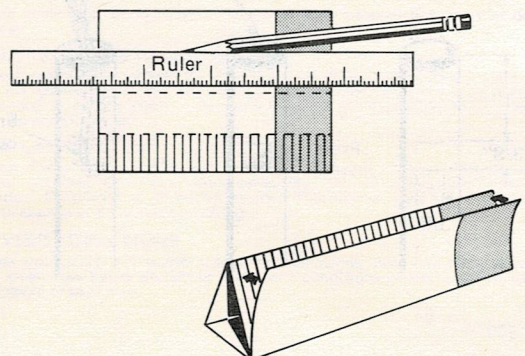

- 8** Using a pencil or stick, place a bead of glue on the inside of the body approximately 2" from the bottom end. Insert the thrust ring into the end of the tube. Using the engine spacer push the thrust ring into the tube until the printed arrows touch the end of the tube. Remove the spacing guide immediately so it won't glue itself in place.

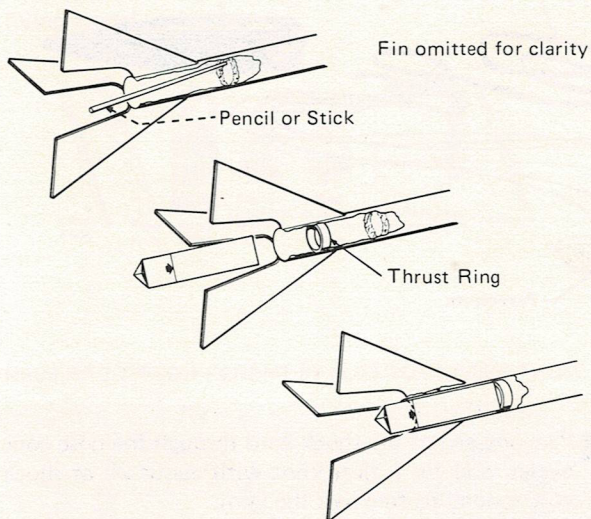

- 9** After the fin assembly has completely dried, run a small bead of glue along both sides of each fin-body tube joint. Using the forefinger, smooth the glue into even fillets. Glue the launch lug onto the body, right against the base of one fin.

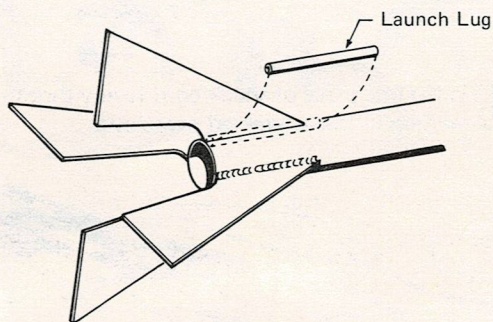

- 10** Cut two slits in the top of the body. Press the indicated area of the tube inward and drop the shock cord down thru the slot. Pull the end of the shock cord back out thru the top of the tube and tie in a firm knot. Press the depressed portion back into place and smear a film of glue over the joint.

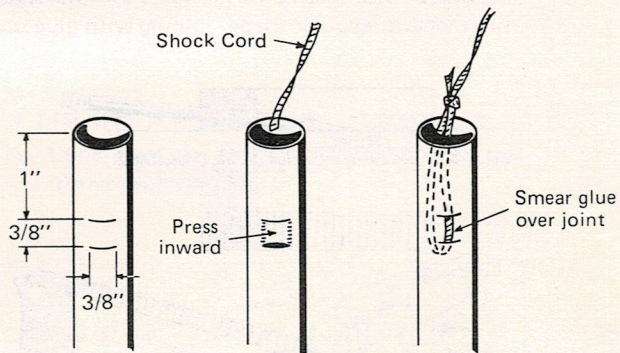

- 11** When the glue has dried, prepare balsa surfaces for a smooth and realistic finish. Fill the wood grain with Centuri fillercoat or sanding sealer. When dry, sand with fine sandpaper. Repeat until smooth.

Lay rocket fin on table edge for easy sanding

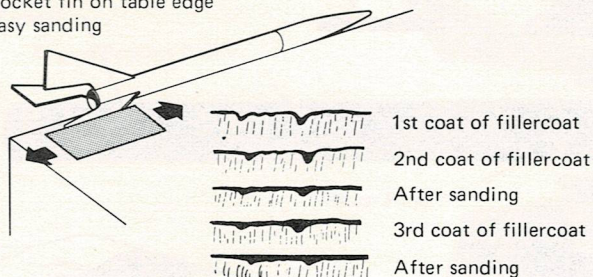

- 12** For best painting results, spray first with enamel primer. When painting plastic parts, never use dope or lacquer! Use enamels only! The plastic cone may be spray painted in place on the model with the same spray paint used on the rest of the model. Or the cone may be removed for painting separate color.

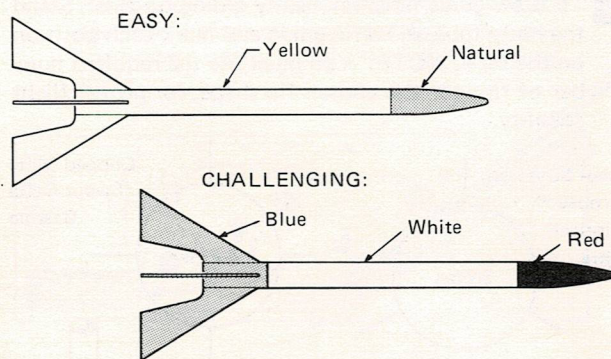

- 13** Spray painting your finished model with a fast-drying enamel will produce the best results... IF IT IS DONE PROPERLY!! Most important is the number of coats of paint. DO NOT try to paint your model with one heavy coat! Instead, give it a couple of quick, light coats first and then a finish coat. Let each coat dry before applying the next.

SPRAYING A TYPICAL MODEL ROCKET

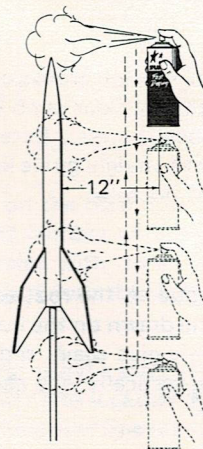

- 14** When the paint is dry, cut out the chrome spec-plate. Peel off the backing paper, and apply on the model wherever you think looks best. Among other things, your spec-plate tells you which engines to use. Apply decorative tape or decals, if you like, to add a personal touch.

Igniters and complete engine installation instructions are included in "Engine Operating Instructions" which accompany all Centuri engines.

The SKY DEVIL can be launched with any of the following engines:

Recommended Engine	Approximate Altitude	Purpose
½A6-4 A8-5	150-250 feet 350-600 feet	First test flight and small launch areas.
B4-6 B6-6	700-900 feet 600-800 feet	General sport flying and medium launch areas.
C6-7	900-1700 feet	Extremely high flights and large launch areas.

1. Be sure to friction fit the engine with tape, as explained in the engine instructions.
2. Inspect recovery system for good condition.
3. Insert Flameproof Parachute Wadding according to its directions.
4. Tuck in shock cord.
5. Inspect chute for good condition. Roll neatly and insert. It must be able to slip out easily because it's a tight fit in this rocket.
6. Nose cone should fit snugly, yet be loose enough to eject.

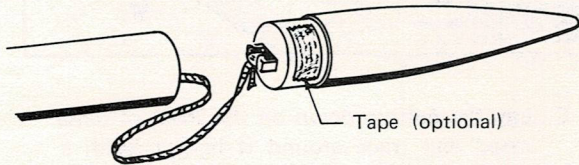

Carefully prepare and check all parts of your rocket before each flight.

Launch the SKY DEVIL from any standard model rocket launcher having a 1/8" diameter x 36" long steel launch rod.

Referring to the specific instructions which accompany Centuri launchers and firing panels, mount the rocket on the launcher and prepare for ignition. Avoid eye injury by capping the exposed tip of the launch rod when not actually launching. Follow the instructions and the Safety Code, and have many happy hours with Model Rocketry.

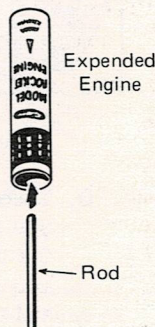

CENTURI ENGINEERING COMPANY
P.O. Box 1988, Phoenix, Arizona 85001

SKY DEVIL

CUSTOM ROCKET

Cat. No. KB-10

The SKY DEVIL is Centuri's answer to the need for a good, inexpensive model rocket with a parachute. With eight fin shapes to choose from you can have a distinctive model rocket with little effort. Take care in tracing and cutting out the fins or they might end up looking like Esther Williams swimming pool.

This rocket is designed to be launched only from standard remote-controlled electrical launch systems. Always use the recommended engines and recovery wadding. Comply with all Federal, State, and local laws.

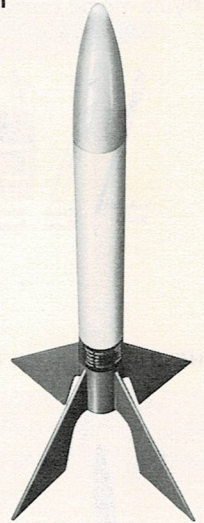

MODEL ROCKETEER'S SAFETY CODE

CONSTRUCTION

My model rockets will be made of only lightweight materials such as paper, wood, plastic, and thin metallic foils, with the exception of payloads and engine holders made of wirelike material.

ENGINES

I will use only pre-loaded factory made model rocket engines in the manner recommended by the manufacturer. I will not change in any way nor attempt to reload these engines.

RECOVERY

I will always use a recovery system in my model rockets that will return them safely to the ground so that they may be flown again.

WEIGHT LIMITS

My model rocket will weigh no more than 453 grams (16 oz.) at liftoff, and the engines will contain no more than 113 (4 oz.) of propellant, as prescribed by Federal Regulations.

STABILITY

I will check the stability of my model rockets before their first flight except when launching models of already proven stability.

LAUNCHING SYSTEM

The system I use to launch my rockets will be remotely controlled and electrically operated, and will contain a switch that will return to "off" when released. I will remain at least 10 feet away from any rocket that is being launched.

LAUNCH SAFETY

I will not let anyone approach a model rocket on a launcher until I have made sure that either the safety interlock key has been removed or the battery has been disconnected from my launcher.

LAUNCH AREA

My model rockets will always be launched from a cleared area, free of any easy-to-burn materials, and I will only use non-flammable recovery wadding in my rockets.

BLAST DEFLECTOR

My launcher will have a blast deflector device to prevent the engine exhaust from hitting the ground directly.

LAUNCH ROD

To prevent accidental eye injury I will always place the launcher so the end of the rod is above eye level or cap the end of the rod with my hand when approaching it. I will never place my head or body over the launching rod. When my launcher is not in use I will always store it so that the launch rod is not in an upright position.

POWER LINES

I will never attempt to recover my rocket from a power line or other dangerous places.

LAUNCH TARGETS AND ANGLE

I will not launch rockets so their flight path will carry them against targets on the ground, and will never use an explosive warhead nor a payload that is intended to be flammable. My launching device will always be pointed within 30 degrees of vertical.

PRE-LAUNCH TEST

When conducting research activities with unproven designs or methods, I will, when possible, determine their reliability through pre-launch tests. I will conduct launchings of unproven designs in complete isolation from persons not participating in the actual launching.

FLYING CONDITIONS

I will not launch my model rocket in high winds, near buildings, power lines, tall trees, low flying aircraft or under any conditions which might be dangerous to people or property.

909,260

TIPS FOR PLASTIC NOSE CONES

This kit contains a plastic nose cone for the forward end of your rocket. While a few other kits still use balsa cones, plastic is now the preferred choice of many rocketeers. It requires no sanding, sealing or painting to have a smooth attractive finish. Plastic is also more durable than balsa . . . it does not dent or "crunch" as easily.

Your nose cone will be assembled from two parts: the cone itself, and an insert which firmly attaches to the cone, holding it inside the body tube.

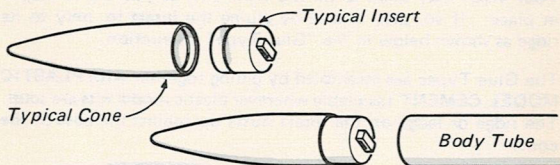

Your cone is one of these two types. Look at the drawings below to see which type you have.

SNAP TYPE

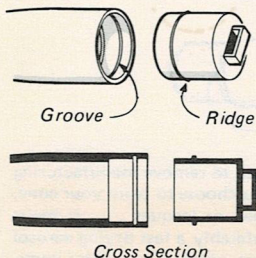

GLUE TYPE

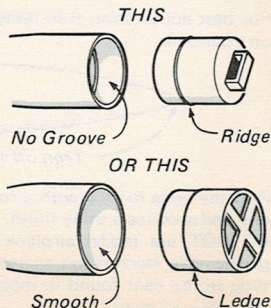

(Cont. on other side)

(Cont. from other side)

The Snap Type is assembled by pushing into the cone until the ridge snaps into the groove.

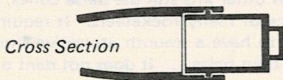

IMPORTANT: The snap type cones should be assembled with care and good judgement, to avoid breaking the cone . . . especially with the shorter #7 and #8 series (.76" and .91" diameter). Your insert may seem to be too tight a fit as you try to snap it in place. If so, play it safe by gluing the insert in, only to its ridge as shown below in the "Glue-Type" instruction.

The Glue Types are assembled by gluing together with PLASTIC MODEL CEMENT (available wherever plastic model kits are sold). The ridge or ledge on the insert butts up against the base of the cone.

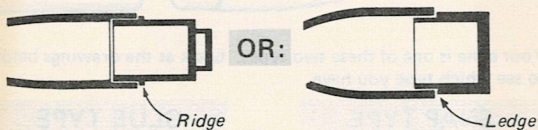

For best appearance, trim away any plastic "flash" that may be on your cone.

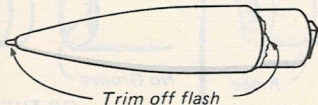

Rub the cone briskly with a soft cloth to remove manufacturing oils, and produce a shiny finish. If you choose to paint your cone, DO NOT use model airplane "dope" or lacquer . . . it melts plastic. We recommend enamel, preferably a fast drying aerosol type (spray can) found in most stores which carry hobby items, hardware, or paint.



Centuri Engineering Co.
P.O. Box 1988
Phoenix, Arizona 85001

ENGINE SPACING GUIDE

- - - FOLD LINE - - -

- - - FOLD LINE - - -

- - - FOLD LINE - - -

GLUE TAB

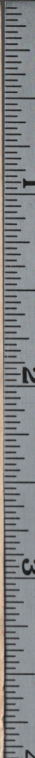
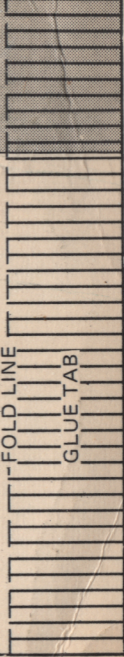

5 3/4" x 3" x 1/16" balsa
2 1/4" launch lug
3" nose cone
13/16" nose cone bottom piece with 5/8" shoulder
9" BT-20 body tube
24" x 1/8" shock cord
3/8" engine block
12" chute pack CP-12

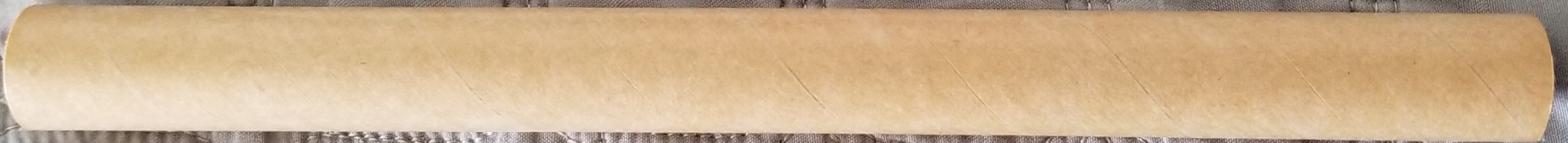
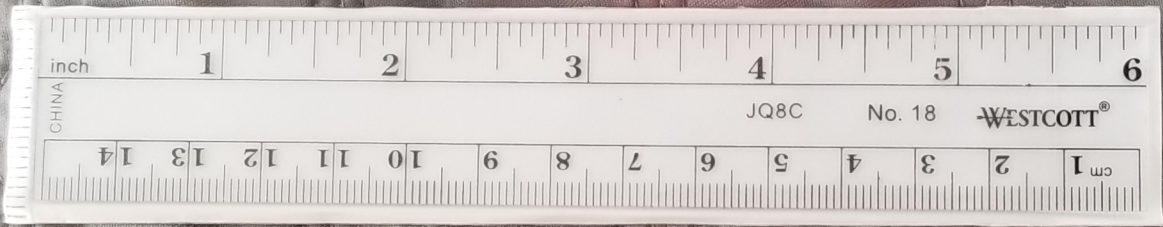

1 MODEL KIT
 1 MODEL & PARTS
 1 MODEL & PARTS

SKY DEVIL

FLYING
 MODEL
 ROCKET

- Build in less than 15 minutes
- Fly 1/2 mile high
- Safe for indoor use



Centuri

STANDARD SKY DEVIL
 1/2" x 1/2" x 1/2" (1/2" x 1/2" x 1/2")
 1/2" x 1/2" x 1/2" (1/2" x 1/2" x 1/2")
 1/2" x 1/2" x 1/2" (1/2" x 1/2" x 1/2")

Centuri

SKY DEVIL

ROCKET KIT WITH LAUNCHER

SKY LEVELS
 1 2 3 4 5 6 7 8 9 10

REQUIREMENTS
 1/2" x 1/2" x 1/2" (1/2" x 1/2" x 1/2")
 1/2" x 1/2" x 1/2" (1/2" x 1/2" x 1/2")

OPTIONAL
 1/2" x 1/2" x 1/2" (1/2" x 1/2" x 1/2")
 1/2" x 1/2" x 1/2" (1/2" x 1/2" x 1/2")



SKY DEVIL

custom rocket

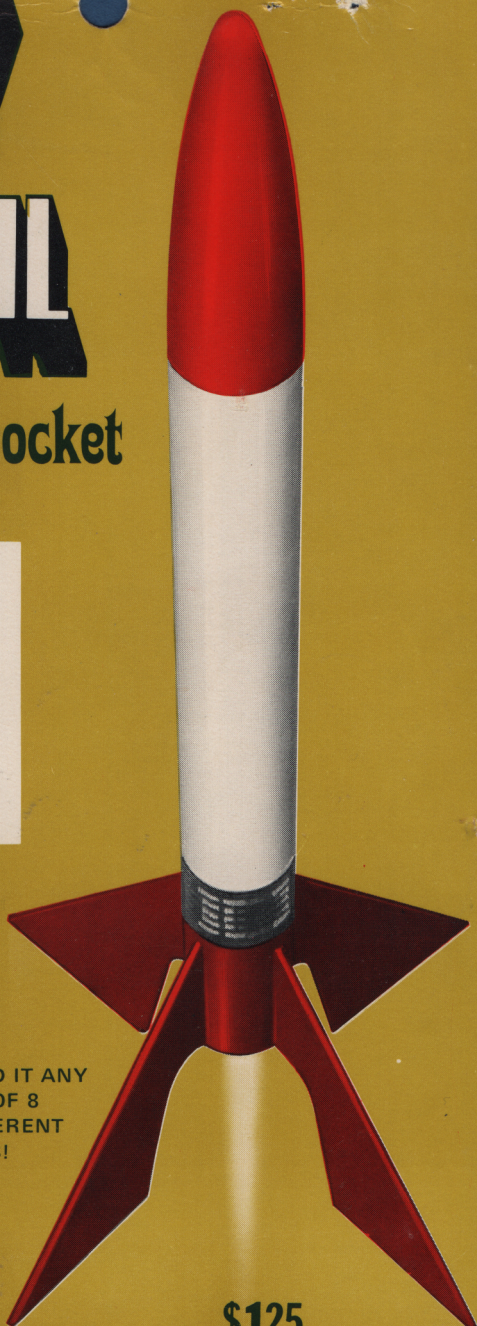

BUILD IT ANY
ONE OF 8
DIFFERENT
WAYS!



\$125

Catalog No. KB-10
Engines not included

ALTITUDES OF 1/3 MILE!
PARACHUTE RECOVERY!
OVER ONE FOOT LONG!
MOLDED NOSE CONE!

IP-531-1172

RECOMMENDED FOR AGES 10 TO ADULT



Centuri

FLYING MODEL ROCKET KIT

Mfg. by Centuri Engineering Co. Phoenix, Arizona

SKY DEVIL'S

FLYING MODEL ROCKET

- Build It Any One Of 8 Different Ways
- Flies 1/3 Mile High
- Safe Parachute Recovery



Centuri SPECIFICATIONS

Designation **SKY DEVIL**

Length **12" +** Net. Wt. **0.8 oz.**

Recom. Engines **1/2 A6-4 AB-5
B4-6 B6-6 C6-7**

Parachute Recovery

IP-637

BONUS
METALLIC
SPEC-PLATE

SIMPLY CUT ON DOTTED
LINE, PEEL OFF BACKING,
AND RUB ONTO ROCKET!

Centuri

KB-10
(#2118)

Engines not incl.

Centuri Engineering Co. Phoenix, Arizona