

SPACE SHUTTLE COLUMBIA

BEFORE YOU START

Read each step and study the accompanying drawings before doing any of the work called for in that step. Make sure you have all parts and materials. Check off each step as you complete it. Always test-fit parts together before applying glue. It will sometimes be necessary to sand edges of rings, tubes, etc. to obtain a proper fit. If you are in doubt about the relative size or location of some parts, refer back to this exploded view drawing for clarification. Adequate glue joints are very important for a flying model rocket. Follow the instructions carefully in this regard.

SKILL LEVEL 2 - Recommended for Intermediate Rocketeers.

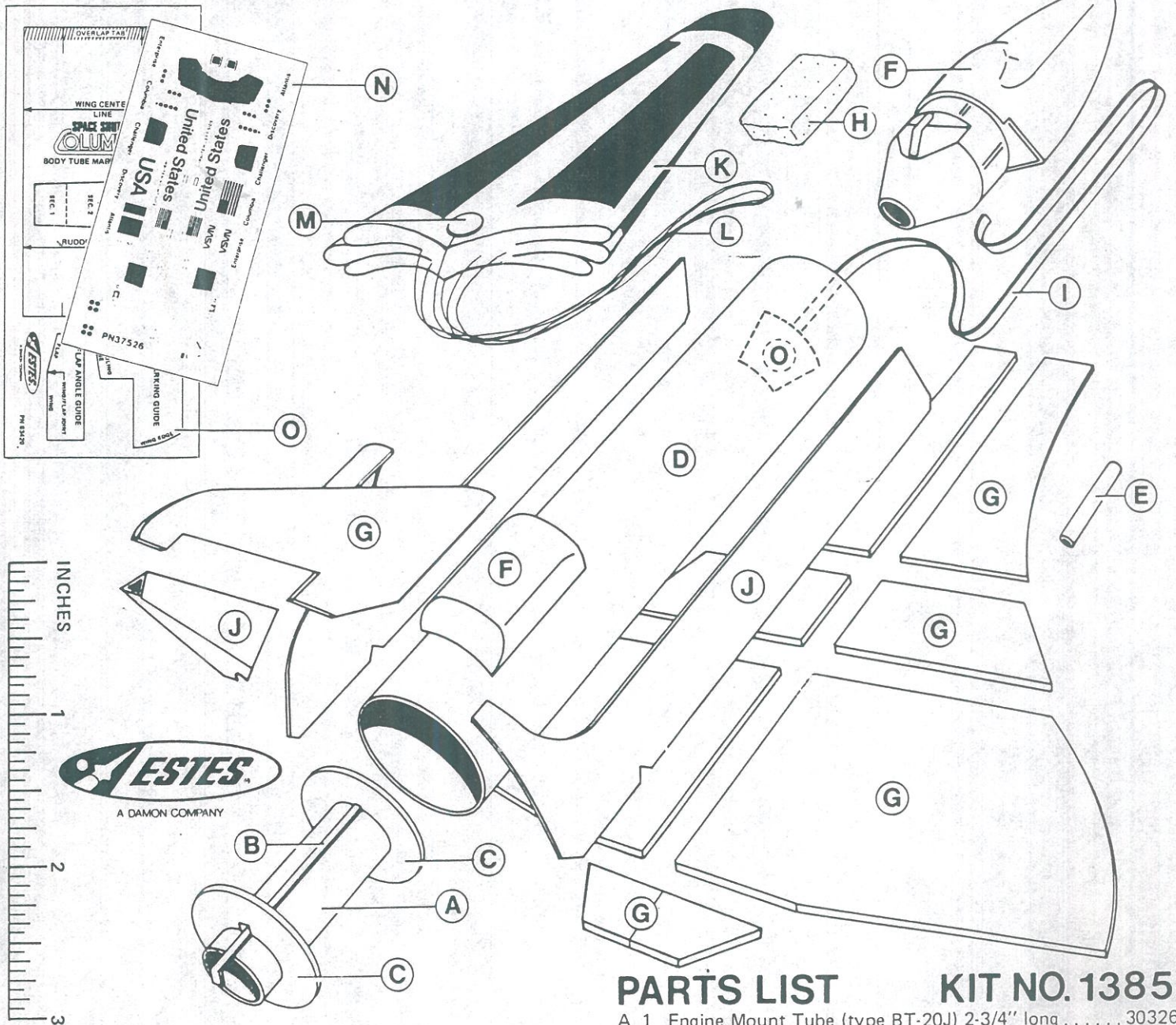

RECOMMENDED ENGINES: A8-3 (First Flight),
B4-4, B6-4, B8-5, C6-5

TOOLS AND MATERIALS

In addition to the parts included in this kit you will need: Scissors, pencil, ruler, fine or extra-fine grit sandpaper, sanding sealer, a medium-size modeling paint brush, modeling knife with sharp blade, wax paper, masking tape, a tube of plastic cement, white and black enamel spray paints, a bottle of medium gray enamel paint, spray "Dull-Cote" (optional), and household white glue or resin glue (Elmer's, Titebond, or similar). Other types of glue are not recommended.

PARTS LIST KIT NO. 1385

A	1	Engine Mount Tube (type BT-20J) 2-3/4" long	30326
B	1	Engine Hook (type EH-2)	35025
C	1	Die-Cut Rings (type RA-2060)	30128
D	1	Body Tube (type BT-60K) 7" long	30414
E	1	Launch Lug (type LL-2B)	38178
F	1	Nose Cone and Pods	72012
G	2	Balsa Wing Set (type BF-1385)	32394
H	1	Clay Weight	85264
I	1	Shock Cord (type SC-1)	85730
J	1	Die-Cut Card	32462
K	1	Parachute (type PK-18A)	85566
L	1	Shroud Line (type SLT-108)	38239
M	1	Tape Discs (type TD-3F)	38406
N	1	Decal Sheet (type KD-1385)	37526
O	1	Pattern Sheet (type SP-1385)	83420

ASSEMBLY INSTRUCTIONS

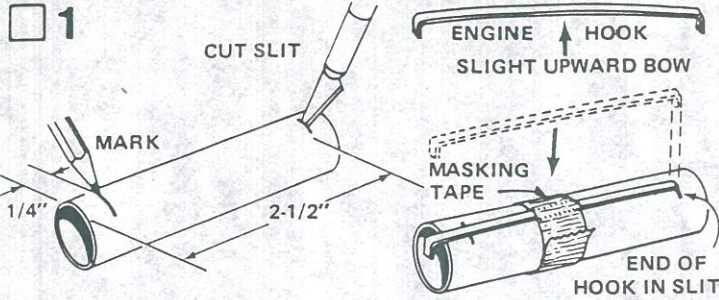

Mark the engine mount tube (part A) 1/4" and 2-1/2" from one end. Cut a 1/8" long slit at the 2-1/2" mark. Gently bend the engine hook (part B) so that it bows upward very slightly in the middle. (Study the drawing — Don't bend the wrong way.) Insert one end of the engine hook into the slit in the tube. Hold hook in place with a piece of masking tape.

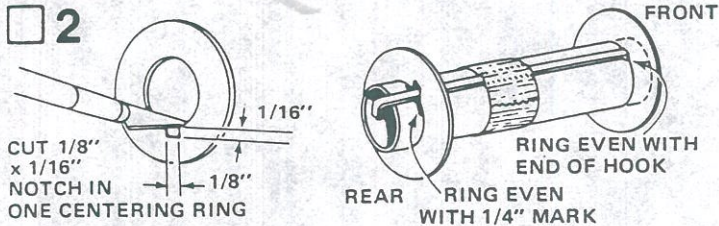

Remove the centering rings from die-cut ring set (part C). Cut a 1/8" wide, 1/16" deep notch in one of the rings. Slide notched ring onto the engine mount tube from rear until it is even with the 1/4" mark and notch is centered over engine hook. Slide the remaining centering ring onto the front of engine mount tube until it is even with the end of the engine hook. Apply a line of glue at the ring/tube joint on both sides of each ring. Set aside until glue is completely dry.

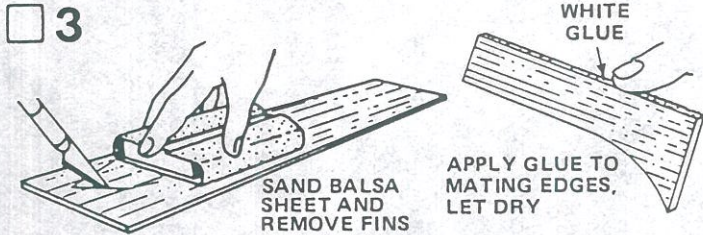

Fine-sand both sides of balsa sheet (part G), then carefully remove the fin and wing parts using a sharp knife to free the edges. Sand the edges of the parts slightly to remove any rough edges — but be careful to leave the edges square and sharp-cornered. Rub a line of glue into the mating edges of all the fin parts as shown and allow the glue to dry.

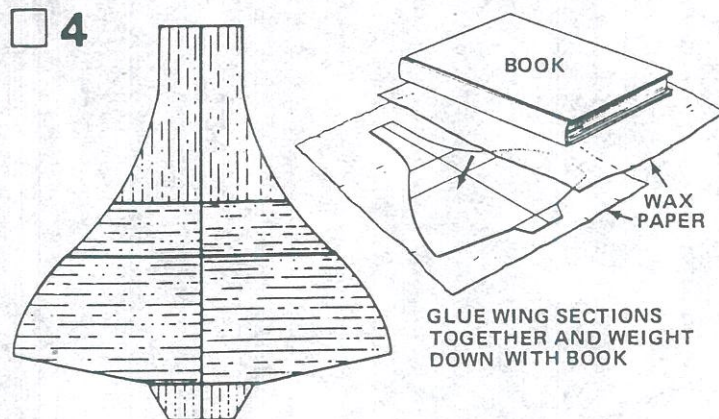

Lay a piece of waxed paper on a flat surface and glue wing sections together as shown using white glue. Cover with waxed paper, weight entire assembly down (with paint bottles or a book) and allow to dry.

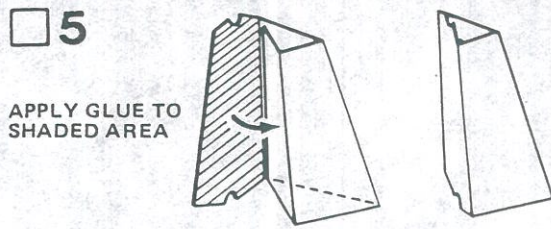

Carefully remove the rudder drag brake from the die-cut sheet (part J). Fold along lines and glue as shown.



Locate one rudder. The other rudder can be discarded or saved to be used for repairs if necessary. Test-fit drag brake into rudder, remove, sand opening top and bottom until rudder fits properly. Apply white glue, and carefully position as shown. Wipe away excess glue. Allow glue to dry.

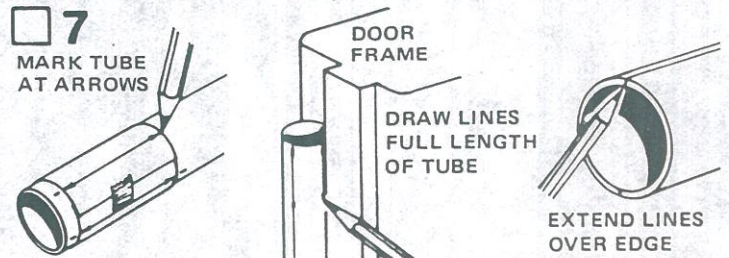

Cut out the tube marking guide from the pattern sheet (part O) and wrap it around the body tube (part D). Mark the body tube at each of the arrow points. Draw straight lines connecting each pair of marks. A door frame inside edge can be used as a guide as shown. Extend the lines down full length of tube. Extend the lines over the edge of tube as shown.

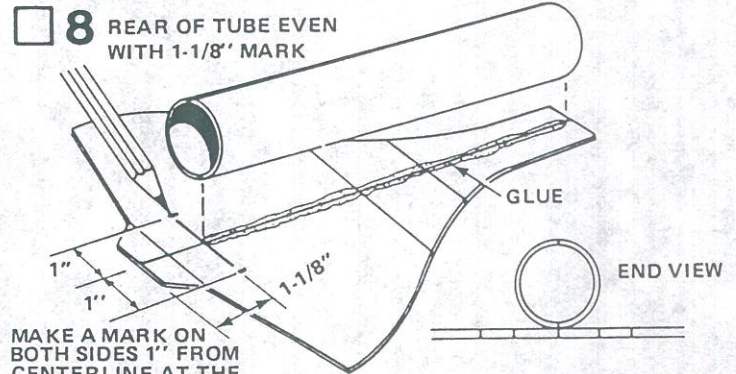

MAKE A MARK ON BOTH SIDES 1" FROM CENTERLINE AT THE 1-1/8" MARK

Using a pencil, make a mark along the centerline of wing 1-1/8" from rear edge and a mark 1" on both sides of the centerline at the 1-1/8" mark. Run a line of glue down centerline of wing. Place body tube on wing using the alignment line and wing centerline as guides. Rear edge of tube should be even with 1-1/8" mark. Check for proper alignment.

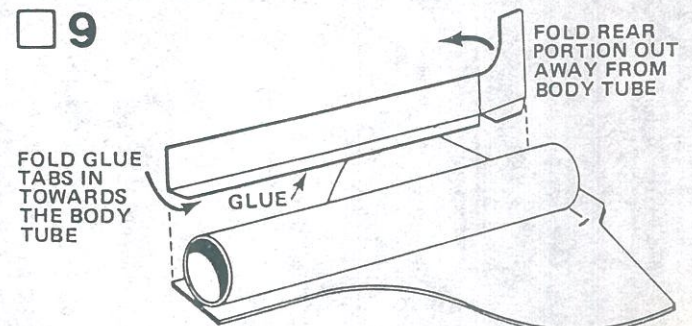

ALIGN REAR PORTION OF FUSELAGE SIDES WITH THE 1" MARK AND STRAIGHT ALONG TUBE SIDE

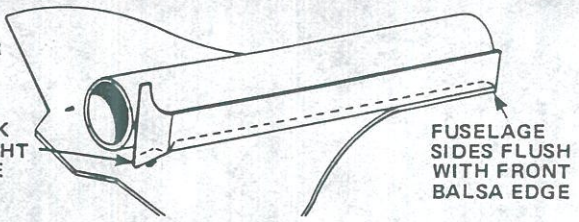

FUSELAGE SIDES FLUSH WITH FRONT Balsa EDGE

Carefully remove the fuselage sides from the die-cut paper parts sheet. Fold the glue tabs as shown. Apply a thin line of glue along the tabs. Position alongside the body tube so that the front edge is even with the front edge of the balsa (not the body tube!) and the rear portion fuselage side is positioned next to the 1" mark as shown. Repeat procedure for other side.

10

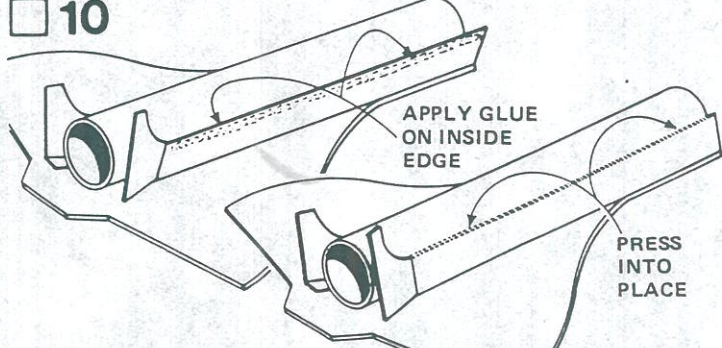

APPLY GLUE ON INSIDE EDGE

PRESS INTO PLACE

Apply glue along the inside edge of top portion of fuselage side. Press into place and run your fingers back and forth along edges until glue sets. Repeat procedure for other side.

11

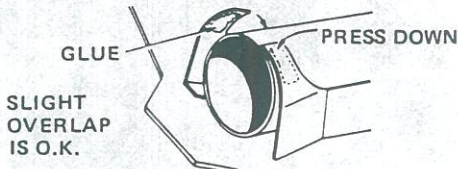

SLIGHT OVERLAP IS O.K.

PRESS DOWN

Apply a thin coating of glue behind the fuselage side's upper section and glue into place as shown. Repeat procedure for other side.

12

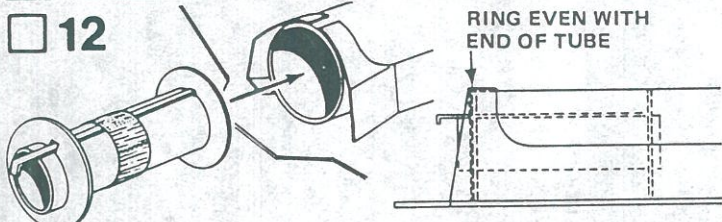

RING EVEN WITH END OF TUBE

Test-fit engine mount into place as shown. Sand if necessary to assure a smooth fit. Remove and apply a ring of glue around the inside of the rear of the body tube. Replace engine mount quickly, before glue sets, so that the rear centering ring is flush with the end of the body tube, and with the engine hook up.

13

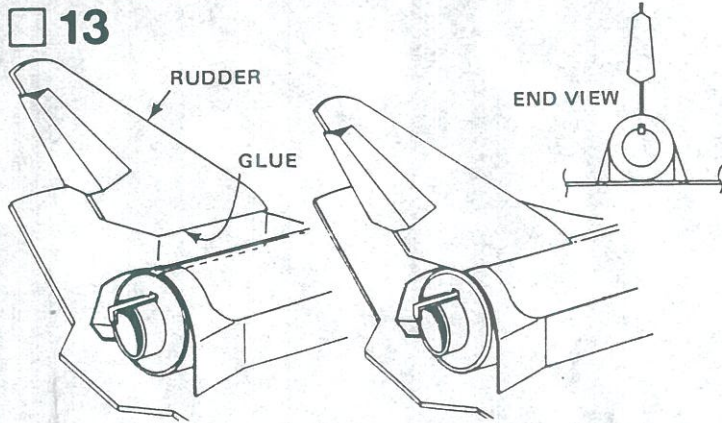

RUDDER

GLUE

END VIEW

Glue rudder in place along its alignment line, making sure the rear is flush with end of body tube.

14

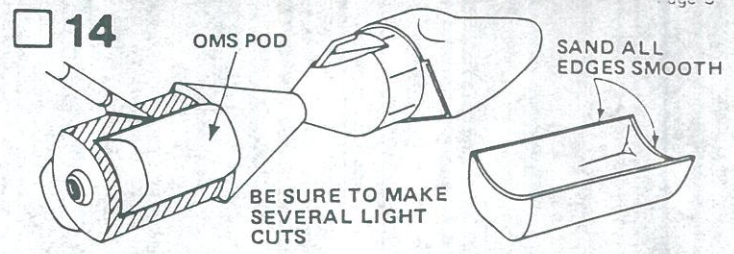

OMS POD

SAND ALL EDGES SMOOTH

BE SURE TO MAKE SEVERAL LIGHT CUTS

Carefully cut the OMS pods from the molded cone piece (part F). Use a sharp modeling knife and make several light cuts instead of one heavy cut. Sand all edges of the OMS pods smooth.

15

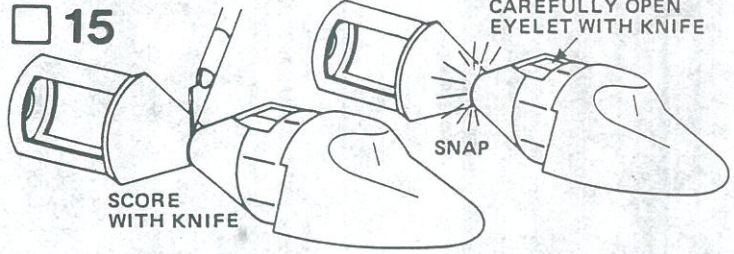

CAREFULLY OPEN EYELET WITH KNIFE

SNAP

SCORE WITH KNIFE

Score nose cone/adaptor joint with a knife as shown. "Snap" the remaining scrap plastic from the nose cone by holding one side in each hand and bending until the part "snaps" at the neck.

16

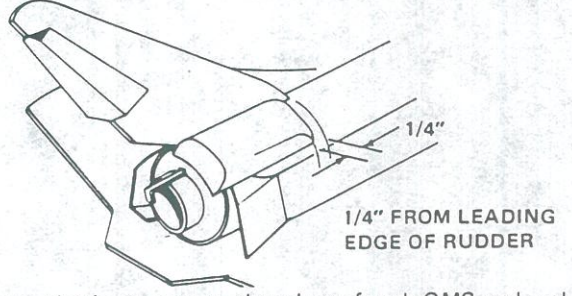

1/4" FROM LEADING EDGE OF RUDDER

Apply tube type plastic cement to the edges of each OMS pod and place it on the body tube as shown. Remove the OMS pods and allow glue to dry. Place another layer of glue on the edges of the OMS pods and replace them, holding them in place until the glue sets.

17

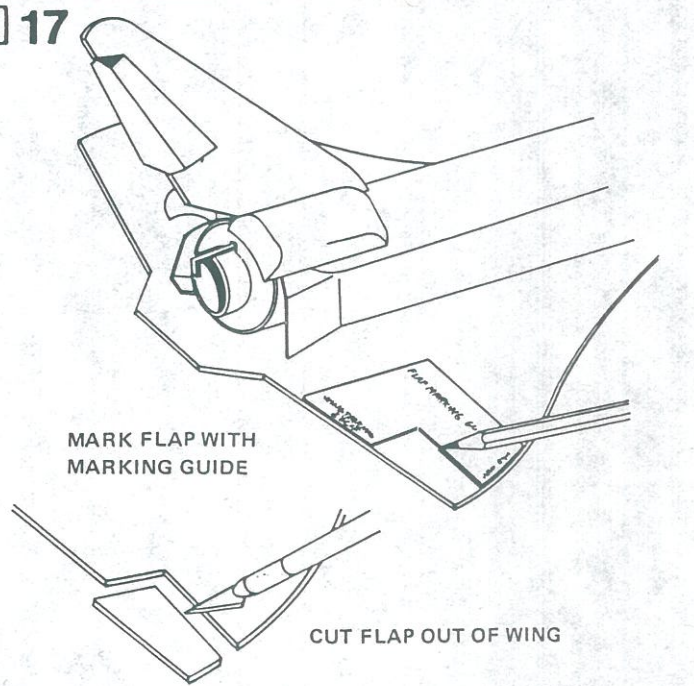

MARK FLAP WITH MARKING GUIDE

CUT FLAP OUT OF WING

Follow the instructions in the next two steps exactly to make the Shuttle fly properly. Cut out the flap marking guide from the pattern sheet. Position guide as shown in the illustration and mark along inside edges of guide with a pencil. Cut along these lines with a modeling knife all the way through the wing.

18

GLUE FLAP TO WING AND POSITION ANGLE GUIDE ON WING. BEND FLAP UP TO PROPER ANGLE

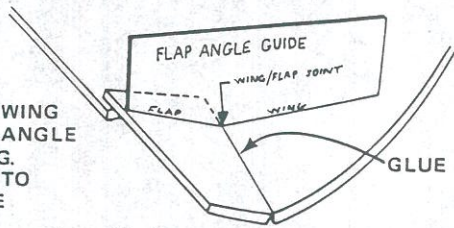

Cut out the flap angle guide from pattern sheet. Apply glue to the edge of flap and position it in place. Allow glue to set, then bend flap up. Place the flap angle guide with edge marked "wing" on the wing and center arrow over wing/flap joint. Bend flap up until it rests evenly against guide. Hold it in position until glue resets. After flap has dried check angle again, if it does not match, hold the joint close to a lighted light bulb for about 30 seconds. The glue will soften from the heat and can be adjusted. Hold flap until joint is cool and angle is accurate.

19

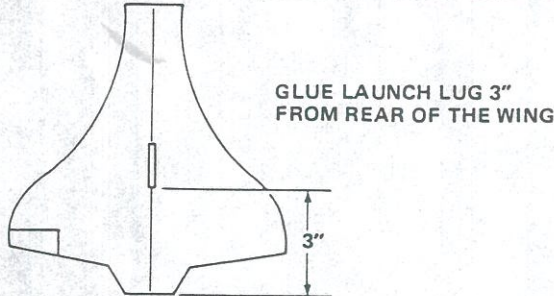

Make a mark on the centerline 3" from the rear of the wing. Apply a line of glue to the launch lug (part E) and place it along the center line at the 3" mark. Be sure to check alignment.

20

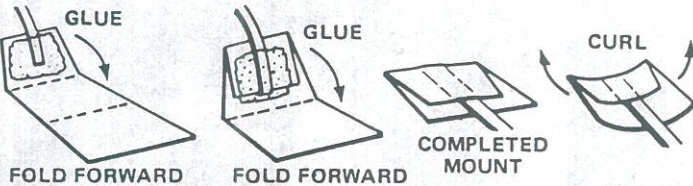

Cut out the shock cord mount from the tube marking guide. Fold on dotted lines, then unfold and apply glue to Section 1. Lay the end of the shock cord (part I) into the glue. Fold over and apply glue to the back of Section 1 and the exposed portion of Section 2. Fold again to complete mount. Curl the edges of the mount down so it will match the contour of the body tube and hold with your fingers until the glue sets.

21 SET BACK TO ALLOW FOR NOSE CONE

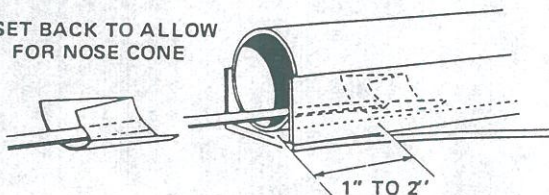

Use a finger or stick to apply glue to the inside of the front of the body tube, 1" to 2" from the front of the tube. Press the shock cord mount firmly into position in glue far enough from the front edge of the tube to allow clearance for the nose cone to fit into place. To insure a good bond use a stick or your finger to smear a film of glue over the mount and surrounding area in the body tube.

22

APPLY THIN LINE OF GLUE

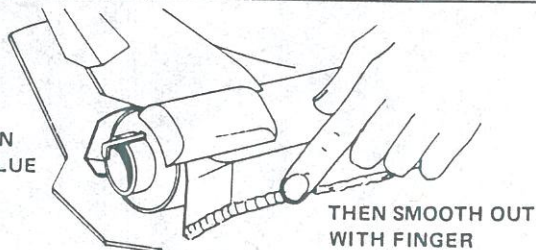

After the glue has dried, apply a glue reinforcement to all glue joints. Hold the model level and apply a line of glue to each

joint. Smooth the glue with a finger as shown. Allow glue to dry thoroughly while the model is in a level position.

23

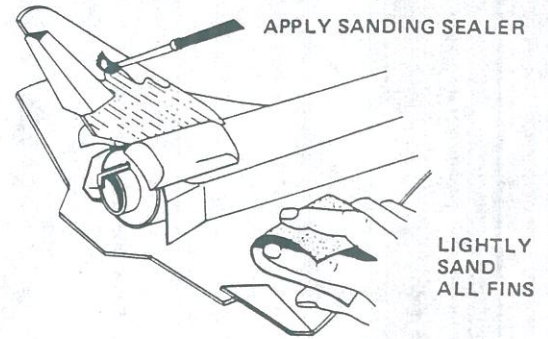

Proper application of sanding sealer makes the rocket look better and reduces drag so that the rocket will fly higher. However, this step is not essential to make a safe, attractive rocket. Apply a coat of sanding sealer to each fin. When sealer is dry, lightly sand all the sealed surfaces. Repeat sealing and sanding process until balsa grain is filled and smooth.

24

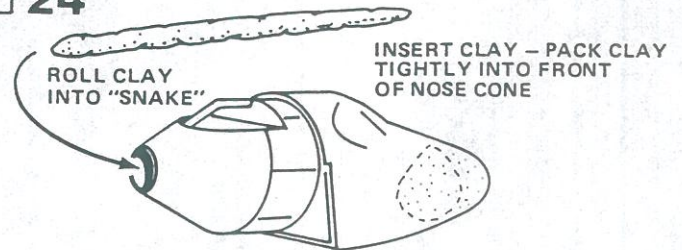

Roll the clay balance weight (part H) between your hands to make a "snake" about 1/8" diameter. Poke the clay through the hole in the rear of the nose cone (part F). Use a pencil or dowel to push the clay forward into the cone until it is packed tightly in the front of the cone.

25

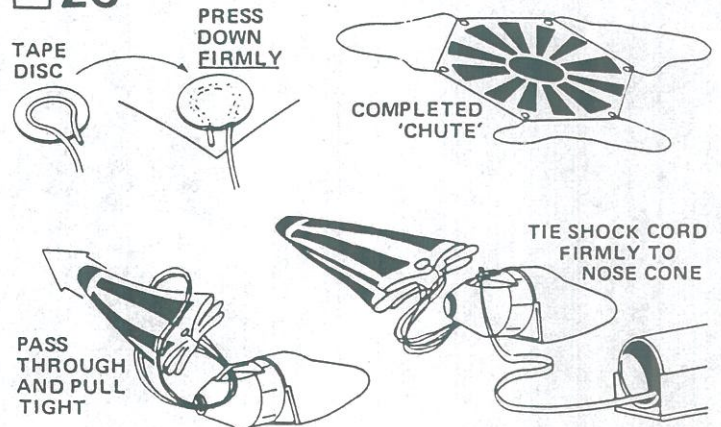

Cut out the parachute (part K) on its edge lines. Cut 3 lengths of shroud line (part L). Attach line ends to the top of the parachute with tape discs (part M) as shown. Form a small loop in the end of a shroud line. Holding loop, gently center loop inside tape disc on the sticky side. Then carefully press tape disc onto its proper place on the top of the parachute. Firmly press the tape disc into place until both tape disc and parachute material are molded around the shroud line loop. Repeat for other shroud line ends and tape discs. Pass the shroud line loops through the loop on the nose cone. Pass the parachute through the loop ends and pull the lines tight against the nose cone. Tie the free end of the shock cord firmly to the nose cone loop. A square knot or strong double knot should be used.

16

- Cut flap angle guide out of pattern sheet.
- Glue edge of flap to wing as shown.
- Check angle of flap with angle guide. After glue has dried check angle again. If incorrect adjust by heating glue joint with light bulb for 30 seconds. Hold angle until joint is cool.

GLUE FLAP TO WING AND POSITION ANGLE GUIDE ON WING.

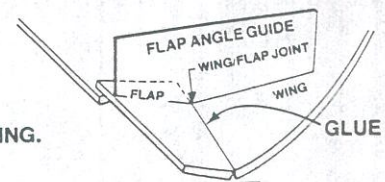

BEND FLAP UP TO PROPER ANGLE

17

- Glue launch lug on wing bottom center line 3 inches from rear of wing. Make certain launch lug is parallel to center line.



GLUE LAUNCH LUG 3" FROM REAR OF THE WING

18

- Cut out shock cord mount from marking guide.
- Fold on dotted lines. Spread glue on section 1 and lay shock cord into glue. Fold over and apply glue to section 2 and back of section 1. Lay shock cord as shown and fold again.
- Clamp assembly together until glue sets.

SHOCK CORD



SPREAD WHITE GLUE HERE

FOLD FORWARD

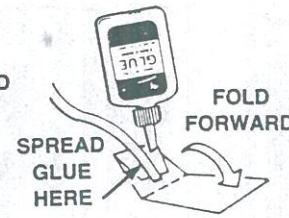

SPREAD GLUE HERE

FOLD FORWARD



19

- Apply glue to inside front of body tube about 1 to 2 inches from end. Glue area should be same size as shock cord mount.
- Press mount firmly into glue as shown.
- Hold until glue sets.

SET BACK TO ALLOW FOR NOSE CONE

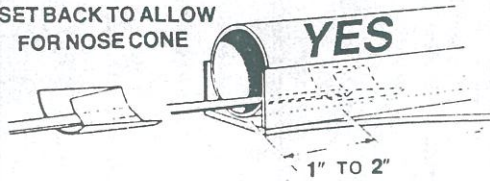

1" TO 2"



20

- Apply glue reinforcements to all glue joints.
- Support rocket in a level position while glue dries.
- After glue is completely dry, apply sanding sealer to all wood parts. When sealer is dry, lightly sand sealed surfaces.
- Repeat sealing and sanding until wood grain is filled and smooth.

APPLY THIN LINE OF GLUE

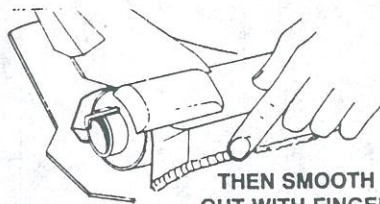

THEN SMOOTH OUT WITH FINGER

APPLY SANDING SEALER

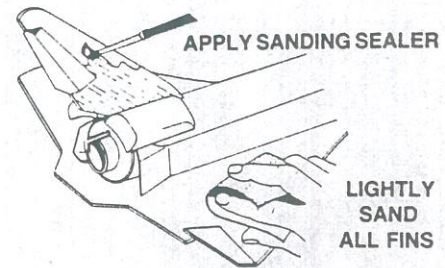

LIGHTLY SAND ALL FINS

21

- Roll clay balance weight between hands to make a snake 1/8 inch in diameter.
- Poke clay through hole in nose cone. Use pencil or dowel to push and pack clay tightly into front of cone. Use all the clay provided.

ROLL CLAY INTO "SNAKE"



INSERT CLAY—PACK CLAY TIGHTLY INTO FRONT OF NOSE CONE

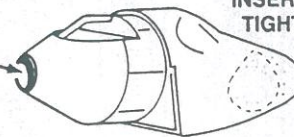

22

- Cut out parachute on edge lines.
- Cut three 22 inch lengths of shroud line.
- Form small loops with shroud line ends and press onto sticky side of tape discs.
- Attach tape discs with line ends to top of parachute as shown.
- Firmly press tape discs into place until both tape discs and parachute material are molded around shroud line loops.
- Pass shroud line loops through eyelet on nose cone. Pass parachute through loop ends and pull lines against the nose cone.
- Tie free end of shock cord to nose cone eyelet.

CUT OUT 'CHUTE

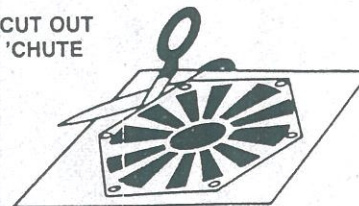

TAPE DISC



PRESS DOWN FIRMLY

CUT THREE LENGTHS OF SHROUD LINE

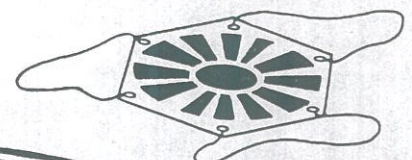
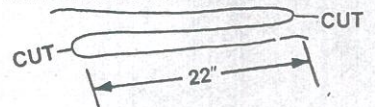

COMPLETED 'CHUTE

PUSH LINES THRU EYELET



PASS 'CHUTE THRU LOOP

PULL TIGHT

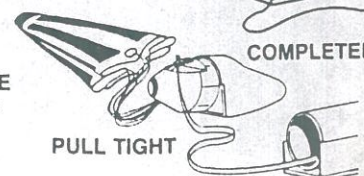

PAINING AND DETAILING

Before painting, wipe the model thoroughly with a damp cloth to remove oily fingerprints. Spray the model white. You need not paint the bottom, but make sure you have a solid covering of white down to where the black color will begin. Spray in several light coats rather than one heavy coat. If you wish to spray the black areas, you must allow the white to dry for at least four hours. If you are going to brush on the black and gray, let the white dry for one hour. After the paint on the Shuttle is dry, apply masking tape along the color break lines between black (or gray) and white portions. (See illustrations.) Cover the white upper portion with paper held in place with tape. Make sure there are no openings where over-spray could sift through onto the white. After the paint is dry, carefully remove the masking material. NOTE: If you brush paint the black, disregard masking instructions. Carefully brush paint the indicated gray areas on the body.

USE ROLLED
UP PAPER FOR
ROCKET
HOLDER

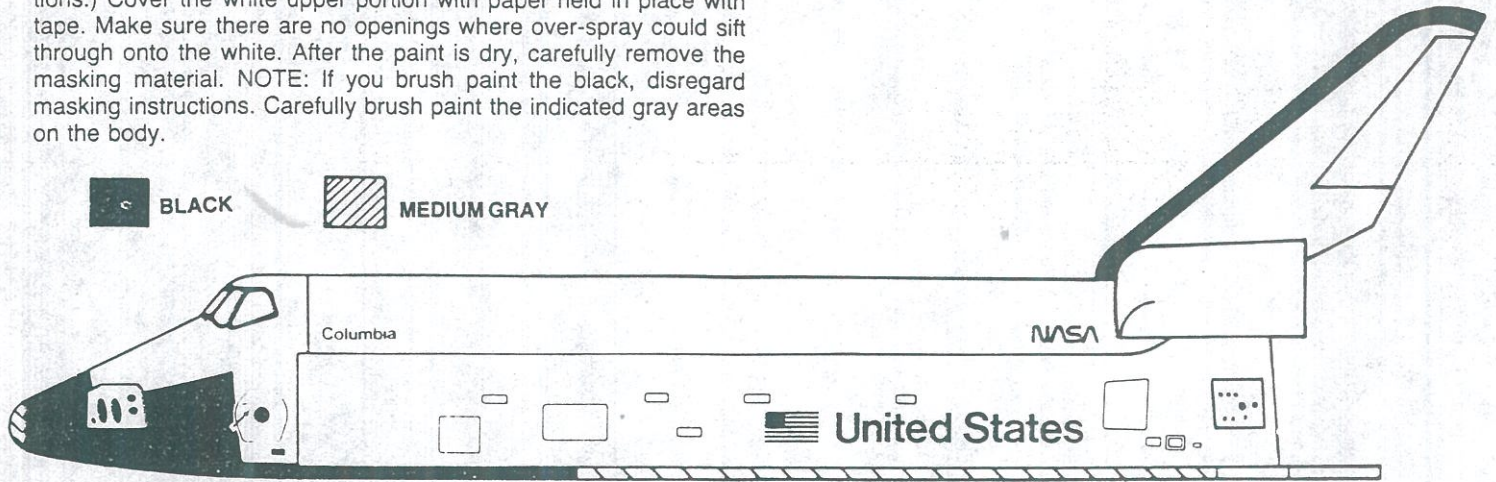
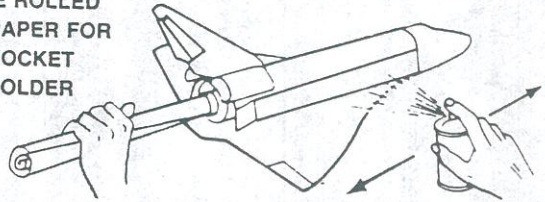

LEFT SIDE VIEW

DECAL PLACEMENT

When all paint is dry, apply the decals in the positions shown. (A) Cut only one decal at a time from sheet. (B) Submerge decal in lukewarm water until decal slides on backing paper (usually 15 to 30 seconds). (C) Gently slide decal from backing paper onto model. (D) Move decal into exact position and carefully blot away excess water with a soft cloth. (E) If the decal "sticks" before you have it in position, apply water over the decal with a brush. This will permit the decal to be moved. (F) Smooth out all wrinkles and air bubbles before the decal dries.

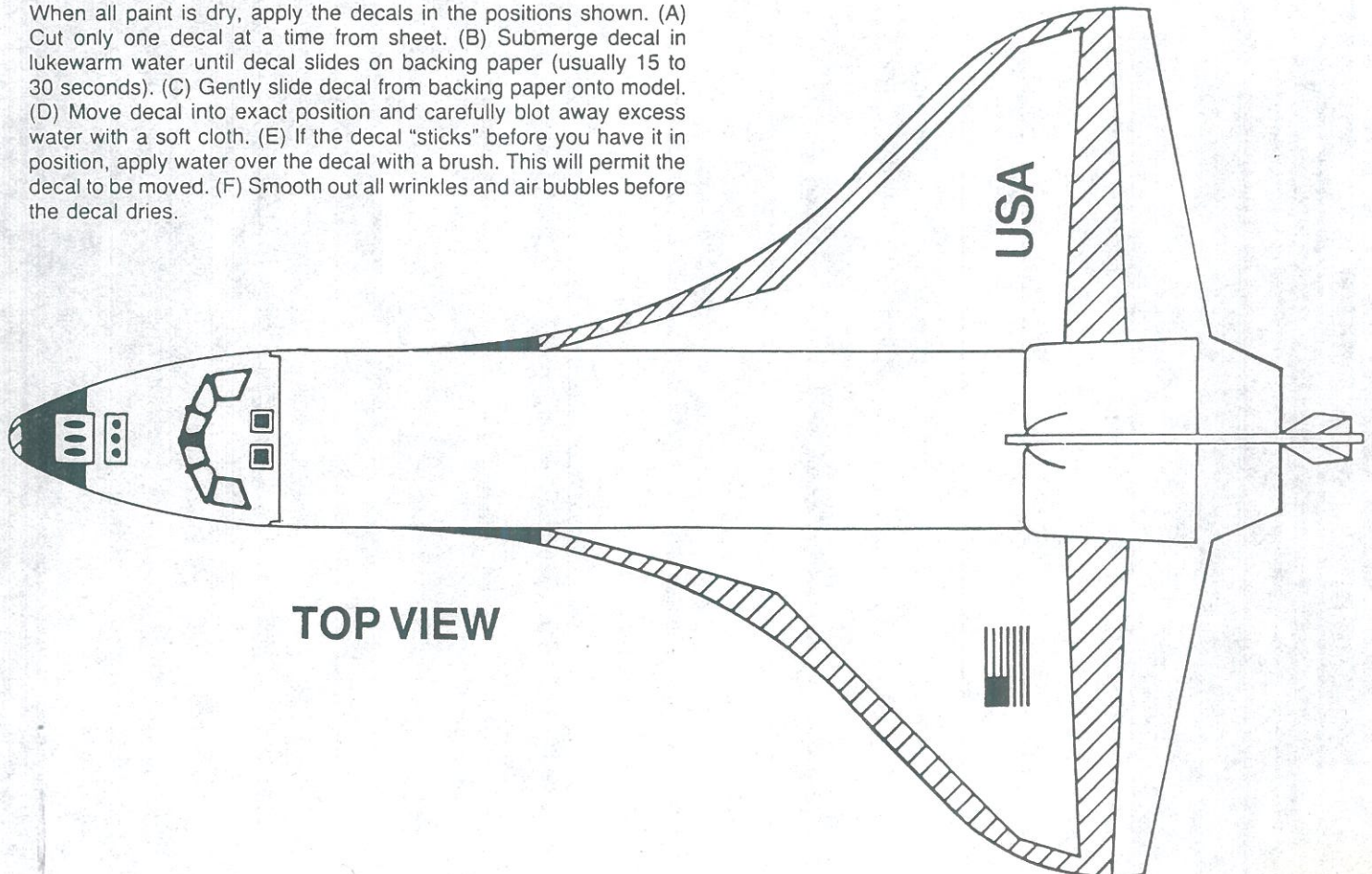

TOP VIEW

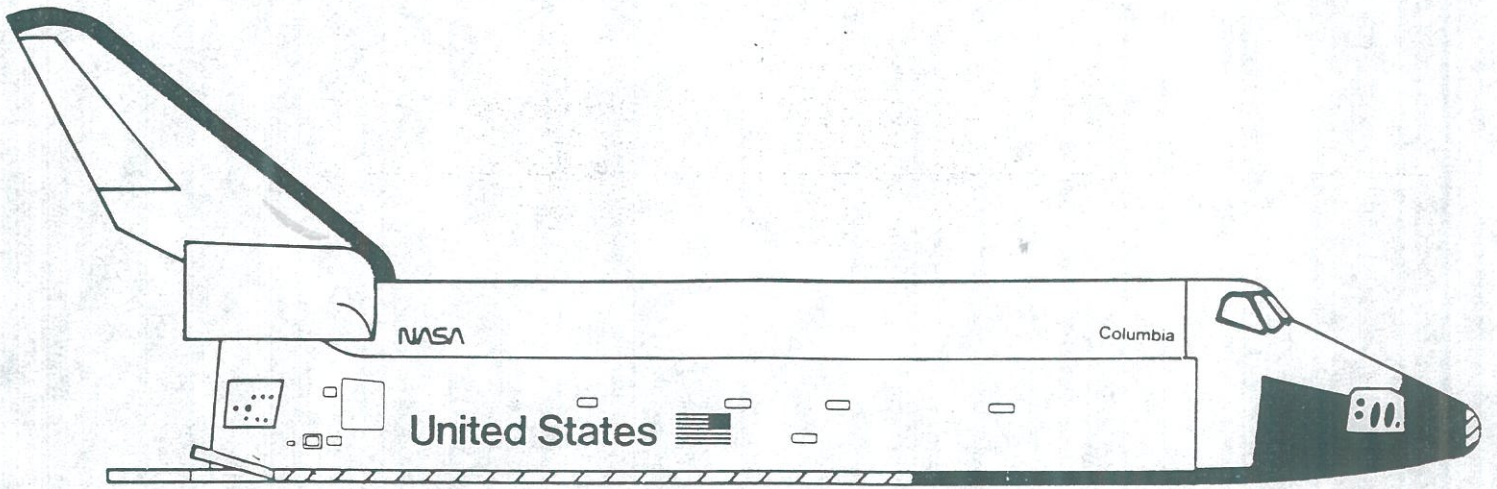

RIGHT SIDE VIEW

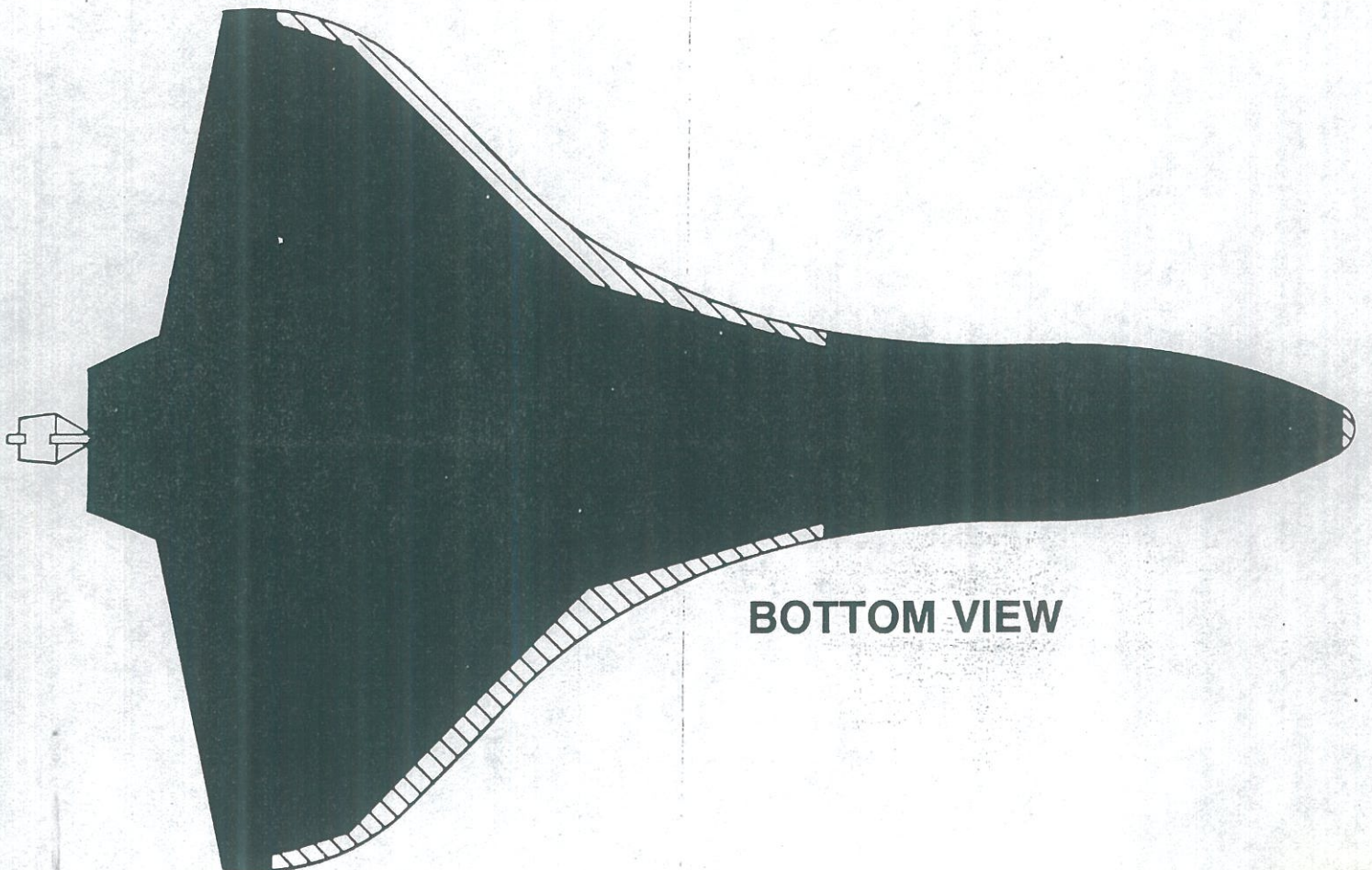

BOTTOM VIEW

ROCKET PREFLIGHT

CRUMPLE AND INSERT 3 SQUARES OF RECOVERY WADDING

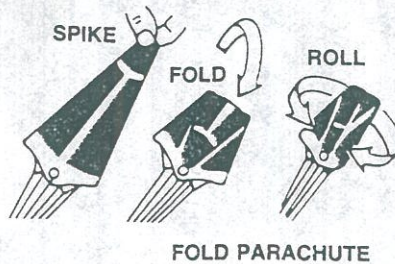
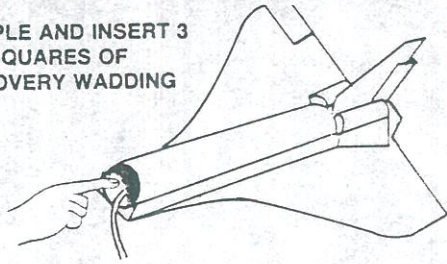

FOLD PARACHUTE

WRAP LINES LOOSELY AROUND CHUTE

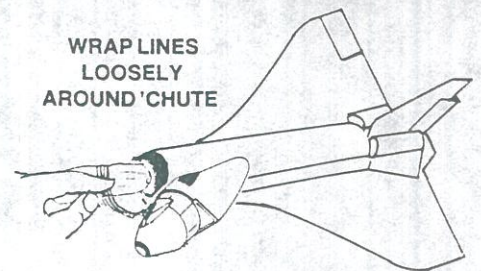

INSERT PARACHUTE IN ROCKET

PREPARE ENGINE

SEPARATE THE IGNITERS

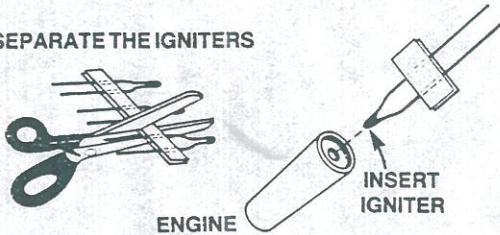

ENGINE

INSERT IGNITER

IGNITER TIP MUST TOUCH PROPELLANT DEEP INSIDE NOZZLE OPENING



FOLD OVER AND BEND TIPS

APPLY AND FIRMLY PRESS TAPE DISC OR MASKING TAPE IN PLACE

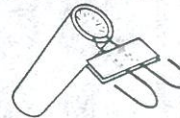

HOOK MUST LATCH OVER END OF ENGINE

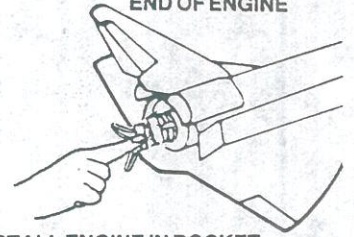

INSTALL ENGINE IN ROCKET

LAUNCH SUPPLIES

To launch your rocket you will need the following items:

- An Estes model rocket launching system
- Estes Parachute Recovery Wadding (No. 2274)
- Recommended Engines: A8-3, B4-4, B6-4, B8-5, C6-5

Use an A8-3 engine for your first flight to become familiar with your rocket's flight pattern.

FLYING YOUR ROCKET

Choose a large field away from power lines, tall trees, and low flying aircraft. Try to find a field at least 250 feet square. The larger the launch area, the better your chance of recovering your rocket. Football fields and playgrounds are great.

Launch area must be free of dry weeds and brown grass.

Launch only during calm weather with little or no wind and good visibility.

Don't leave parachute packed more than a minute or so before launch during cold weather [colder than 40° Fahrenheit (4° Celsius)].

MISFIRES

Failure of the rocket engine to function properly is nearly always caused by a failure to install the igniter correctly. This failure permits the igniter to heat and burn into two pieces without igniting the engine.

FOR YOUR SAFETY AND ENJOYMENT

Always follow the NAR-HIA* MODEL ROCKETRY SAFETY CODE while participating in any model rocketry activities.

*National Association of Rocketry-The Hobby Industry of America

COUNTDOWN AND LAUNCH

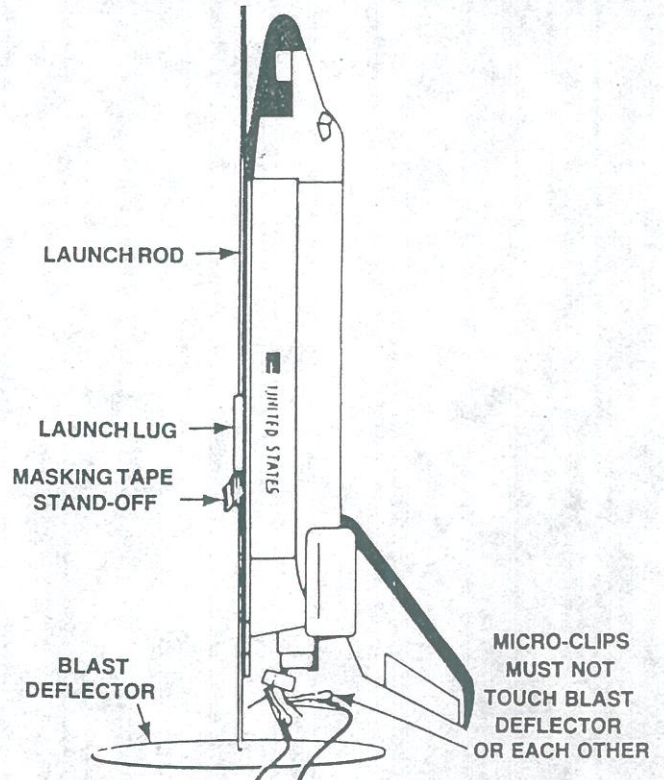

- 5 REMOVE SAFETY KEY to disarm the launch controller.
- 4 Remove safety cap and slide launch lug over launch rod to place rocket on launch pad. Make sure the rocket slides freely on the launch rod.
- 3 Attach micro-clips to the igniter wires. Arrange the clips so they do not touch each other or the metal blast deflector. Attach clips as close to protective tape on igniter as possible.
- 2 Move back from your rocket as far as launch wire will permit (at least 15 feet).
- 1 INSERT SAFETY KEY to arm the launch controller.

LAUNCH!!! PUSH AND HOLD LAUNCH BUTTON UNTIL ENGINE IGNITES

Remove safety key—Replace cap on rod.

PAINTING AND DETAILING

USE ROLLED UP PAPER FOR ROCKET HOLDER

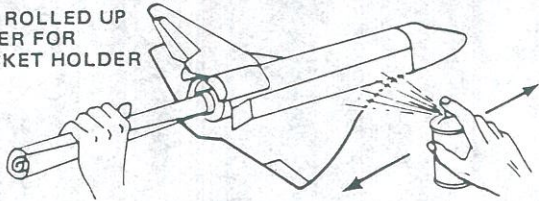

Before painting, wipe the model thoroughly with a damp cloth to remove oily fingerprints. Spray the model white. You need not paint the bottom, but make sure you have a solid covering of white down to where the black color will begin. Spray in several light coats rather than one heavy coat. If you wish to spray the black areas, you must allow the white to dry for at least four hours. If you are going to brush on the black, let the white dry for one hour. After the paint on the Shuttle is dry, apply masking tape along the color break lines between black (or gray) and white portions. (See illustrations.) Cover the white upper portion with paper held in place with tape. Make sure there are no openings where over-spray could sift through onto the white. After the paint is dry, carefully remove the masking material. **NOTE:** If you brush paint the black, disregard masking instructions. Carefully brush paint the indicated gray areas on the body.

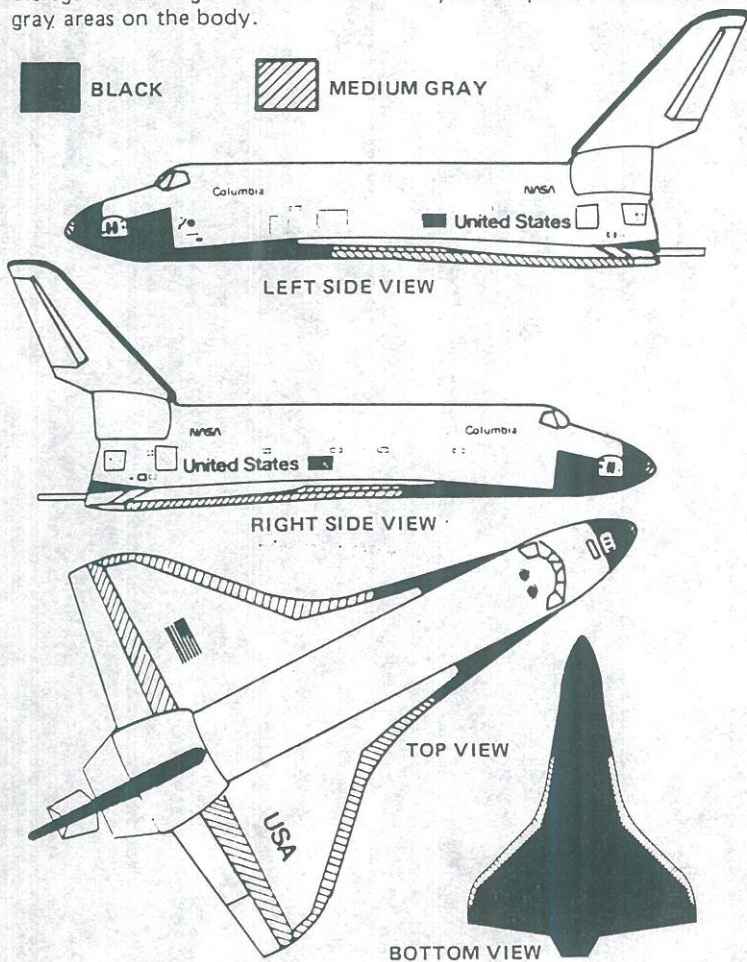

DECAL PLACEMENT

When all paint is dry, apply the decals (part N) in the positions shown. (A) Cut only one decal at a time from sheet. (B) Submerge decal in lukewarm water until decal slides on backing paper (usually 15 to 30 seconds). (C) Gently slide decal from backing paper onto model. (D) Move decal into exact position and carefully blot away excess water with a soft cloth. (E) If the decal "sticks" before you have it in position, apply water over the decal with a brush. This will permit the decal to be moved. (F) Smooth out all wrinkles and air bubbles before the decal dries. We recommend that the completed model be sprayed with Testor's "Dull-Cote". This is a clear flat spray paint that kills the decal shine and protects the model's finish.

LAUNCHING COMPONENTS

To launch your rocket you will need the following items:

- An Estes model rocket launch system
 - Flameproof recovery wadding (Estes Cat. No. 2274)
 - Estes A8-3, B4-4, B6-4, B8-5, or C6-5 model rocket engines.
- Use an A8-3 engine for your first flight.

Be sure to follow the HIAA-NAR* Model Rocket Safety Code when carrying out your model rocket activities.
 *HIAA - Hobby Industry Association of America
 NAR - National Association of Rocketry

COUNTDOWN CHECKLIST

T-14 Remove nose cone. Pack four squares of loosely crumpled recovery wadding into body tube.

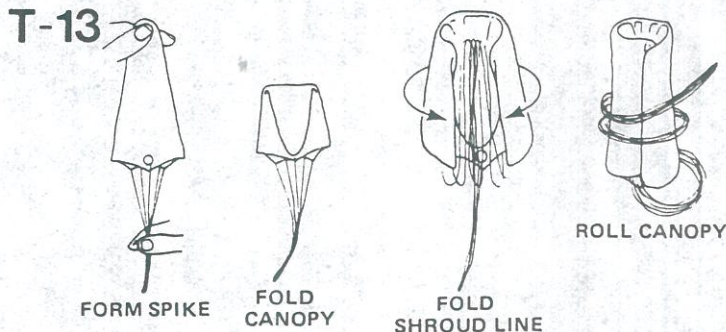

Hold the parachute at its center and pass the other hand down it to form a "spike" shape. Fold this spike in half. Fold shroud lines back along parachute and then back down to lower edge of parachute to reduce length of shroud line "left over". Roll parachute into tube shape to fit easily into body. Any remaining shroud line should be loosely wrapped around parachute. Pack 'chute into the body tube on top of the wadding. Pack the shroud lines and shock cord in on top of the parachute and slip the nose cone into place.

NOTE: DO NOT pack parachute until you are actually ready to launch. For maximum parachute reliability, lightly dust the 'chute with ordinary talcum powder before each flight, especially in cold weather.

T-12 Pack shock cord neatly into rocket, then slide nose cone into place. Nose cone should separate easily from rocket body tube but should not be extremely loose. If it is too tight, sand inside of body tube end and shoulder of nose cone with extra fine sandpaper. If nose cone is too loose, add a wrapping of masking tape to the shoulder of the nose cone.

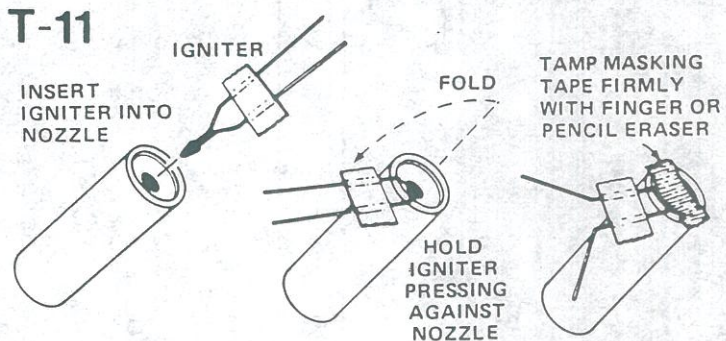

Select an engine and install an igniter as directed in the engine instructions. The engines recommended for use with this rocket are the A8-3, B4-4, B6-4, B8-5, or C6-5 made by Estes.

Use an A8-3 engine for your first flight.

T-10

ENGINE HOOK MUST
LATCH SECURELY

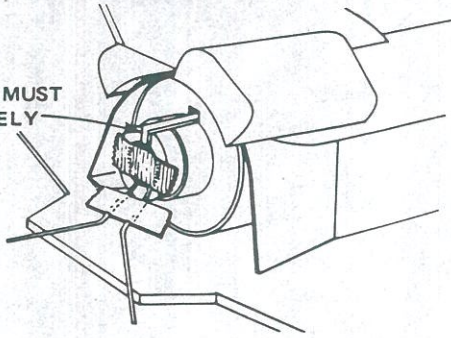

Insert engine into rocket engine mount. Engine hook must latch securely over end of the engine.

T-9 Disarm the launch panel – REMOVE SAFETY KEY!

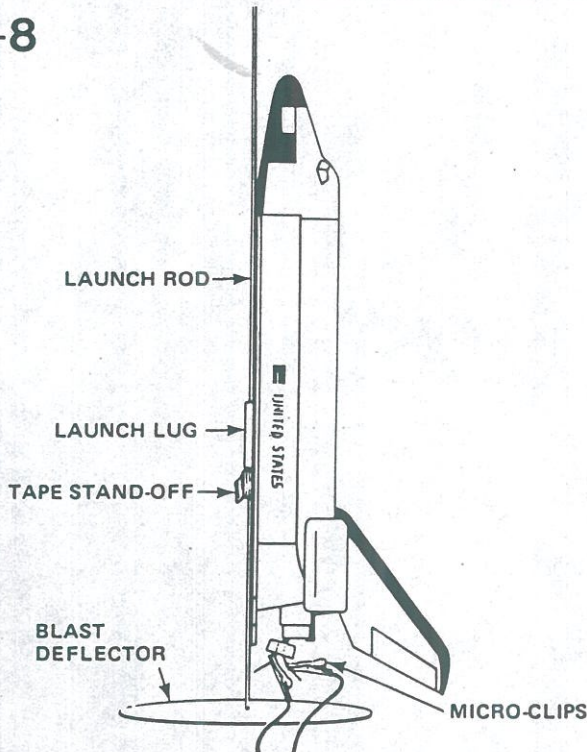
T-8

Slide launch rod through rocket launch lug and place rocket on launch pad. Make sure the rocket slides freely on the launch rod. Clean the micro-clips and attach them to the igniter wires. Arrange the clips so they do not touch each other or the metal blast deflector. Attach clips as close to protective tape on igniter as possible.

T-7 Clear the launch area. Alert recovery crew and trackers. Check for low flying aircraft and unauthorized persons in the recovery area.

T-6 Arm the launch panel – INSERT SAFETY KEY!

-5-4-3-2-1-LAUNCH!!

Repeat Countdown Checklist for each flight.

MISFIRE PROCEDURE

Disarm the launch panel. Wait one minute before approaching the rocket on the launch pad. Remove the rocket, clean the igniter residue from the nozzle of the engine, and carefully install a new igniter. Repeat the Countdown Checklist.

Failure of the rocket engine to function properly is nearly always caused by a failure to install the igniter correctly. This failure permits the igniter to heat and burn into two pieces without igniting the engine.



A DAMON COMPANY

ESTES INDUSTRIES
PENROSE, CO 81240 USA