



The World Leader in Model Rocketry
1295 H Street, Penrose CO 81240

MIGHTY MITES™

READY TO FLY

FLYING MODEL ROCKET INSTRUCTIONS

Use these instructions for each of your Mighty Mite™ rockets.

1. ROCKET STREAMER ATTACHMENT

A. Pull the nose cone out of the rocket body.

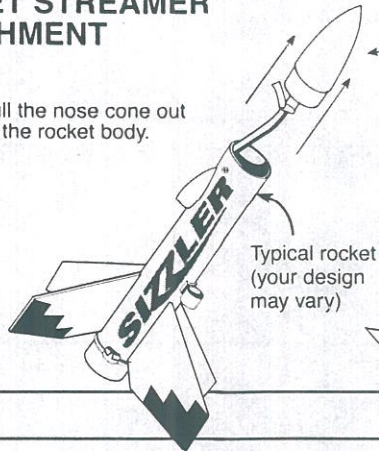

B. Measure 1" (2.5 cm) from the nose cone and tie streamer to shock cord with a double knot.

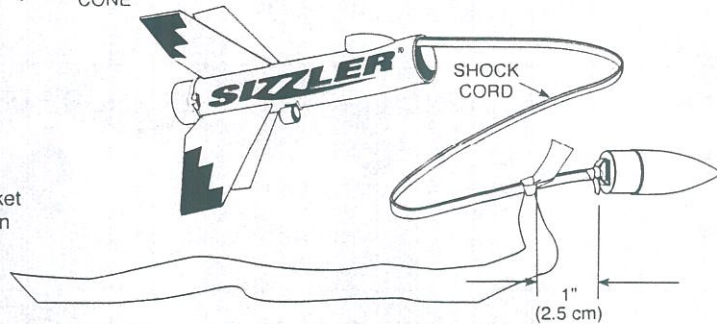

2. PREPARE STREAMER FOR FLIGHT

A. Loosely crumple and insert 1/4 of a square of recovery wadding into rocket body.

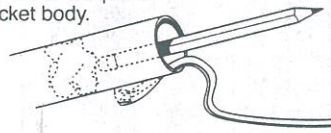

IMPORTANT:
Wadding must be in place and slide freely for rocket to work properly!

B. FOLD STREAMER

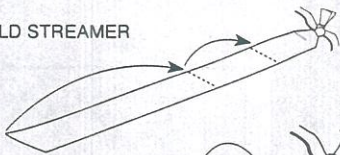

C. ROLL



D. Wrap shock cord loosely around streamer. Insert streamer into rocket. Streamer should slide easily into body tube. If fit is too tight, unfold and repack.

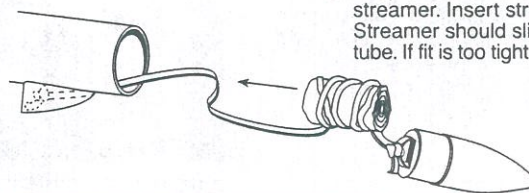

3. PREPARE ENGINE FOR FLIGHT

WARNING : FLAMMABLE
BEFORE PROCEEDING, READ INSTRUCTIONS AND NAR SAFETY CODE INCLUDED WITH ENGINES. PREPARE YOUR ENGINE **ONLY** WHEN YOU ARE **OUTSIDE** AT THE LAUNCH SITE PREPARING TO LAUNCH! If you do not use your prepared engine, remove the igniter before storing your engine.

A. Separate igniter and igniter plug.

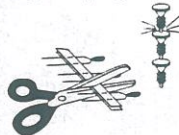

B. Twist off retainer ring at rear of rocket.

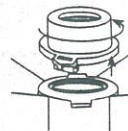

C. Slide engine into rocket body as shown.

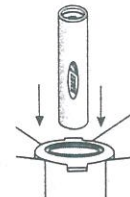

D. Twist retainer ring into locked position to hold engine in place.

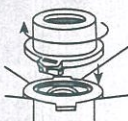

E. Hold rocket upside down and drop in igniter. Igniter must touch propellant.

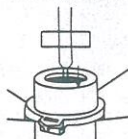

F. Insert igniter plug.



G. Firmly push igniter plug all the way in.



H. Bend igniter wires back as shown.

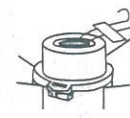

LAUNCH SUPPLIES

To launch your rocket, you will need the following:

- Launch Pad (Estes Porta-Pad® II or Mighty Mites™ Launch Set)
- Launch Controller (Estes Electron Beam® or Mighty Mites™ Launch set)
- Recommended Estes Engines: 1/4A3-3T, 1/2A3-4T, A3-4T, or A10-3T. Use a 1/4A3-3T for your first flight to become familiar with your rocket's flight pattern.
- Recovery Wadding (EST 302274)
- Igniters and Igniter Plugs (included with all Estes engines) Use only Estes products to launch this rocket.

ENGINE	PROJECTED ALTITUDE	
	FEET	METERS
1/4A3-3T	110	34
1/2A3-4T	225	69
A3-4T	400	122
A10-3T	365	111

TIPS FOR FLYING YOUR ROCKET

- Choose a large field away from power lines, buildings, tall trees, and low flying aircraft. Try to find a field at least 250 feet (76 meters) square. The larger the launch area, the better your chance of recovering your rocket.
- Launch area must be free of dry weeds and brown grass.
- Launch only during calm weather with little or no wind and good visibility.
- Don't leave streamer packed more than a minute or so before launch during cold weather (colder than 40° Fahrenheit [4° Celsius]). Streamer may be dusted with talcum or baby powder to avoid sticking.
- Always follow the National Association of Rocketry (NAR) MODEL ROCKETRY SAFETY CODE while participating in any model rocketry activities. The safety code is enclosed with this kit.

COUNTDOWN & LAUNCH INSTRUCTIONS FOR ELECTRON BEAM® / PORTA-PAD® SET

- 10...** Safety key must not be in launch controller. The safety cap with safety key attached should already be on the launch rod.

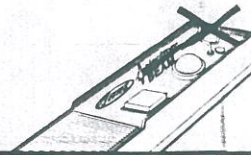

- 9...** Remove safety cap from launch rod, slide launch lug over rod. Make sure rocket slides freely and micro-clips are clean for good electrical contact.



- 8...** Attach micro-clips to the igniter wires. Arrange the micro-clips so they do not touch each other or the metal blast deflector. Attach micro-clips as close to protective tape on igniter as possible.

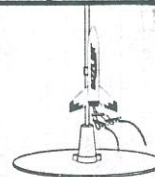

- 7...** Move everyone back from your rocket as far as launch wire will permit at least 15 feet (5 meters).

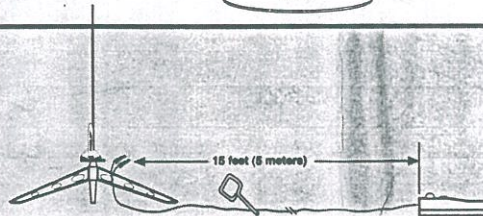

- 6...** Insert safety key to arm the launch controller.

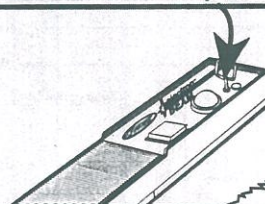

- 5...** Start audible countdown.

4...3...2...1.....

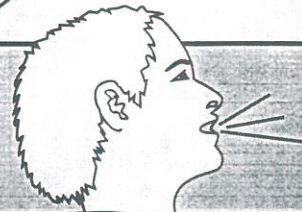

LAUNCH!

Push and hold button until engine ignites.

For safety, immediately remove safety key from launch controller and replace safety cap on launch rod.

MISFIRES

When an ignition failure occurs, **remove the safety key from the launch control system and wait one minute before approaching the rocket.** Remove the expended igniter from the engine and install a new one. Be certain the coated tip is in direct contact with the engine propellant. Broken or chipped coating will not affect the performance of the igniter. Reinstall the igniter plug as illustrated previously. Repeat the countdown and launch procedure.



ESTES INDUSTRIES
1295 H Street
Penrose, CO 81240

MIGHTY MITES™ LAUNCH SYSTEM INSTRUCTIONS

EST 1841
(10-98) 82170

PARTS LAYOUT

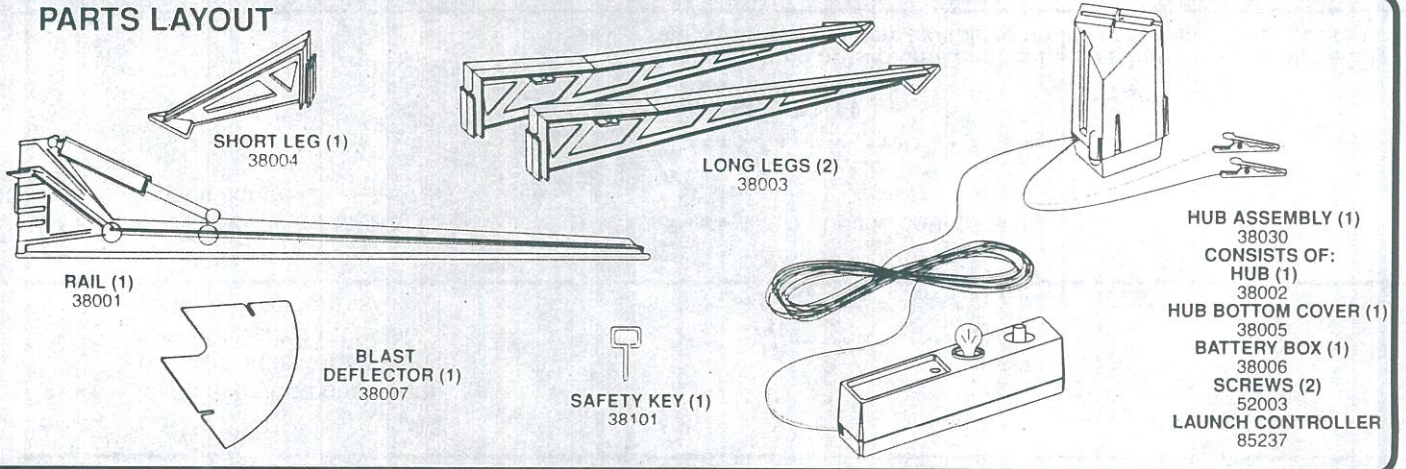

FOR YOUR SAFETY

Please note that the Mighty Mites™ Launch Controller has a safety key. When the safety key is inserted into the Mighty Mites™ Launch Controller, it activates the launch system that ignites the model rocket's engine. To prevent potentially serious injury to yourself and others, always follow these simple safety rules:

- NEVER connect the Mighty Mites™ Launch Controller to an igniter, a flight-ready engine or a rocket until you are outside at the launch site preparing to launch.
- At the launch site, keep the safety key with you at all times and never insert the safety key into the Mighty Mites™ Launch Controller while you or any others are near the rocket.
- Insert the safety key into the Mighty Mites™ Launch Controller only when you and all others are at least 15 feet (5 meters) away from the flight-ready rocket.
- In case of misfire, never approach or allow any others to approach the rocket until you have removed the safety key from the Mighty Mites™ Launch Controller and waited one full minute to be sure rocket's engine is not going to ignite.
- Remove the safety key from the Mighty Mites™ Launch Controller immediately after each and every rocket launch.

NOTE: The Mighty Mites™ Launch Set requires four AA batteries (not included). Only alkaline batteries are recommended. Do not mix old and new batteries or alkaline, standard, and rechargeable batteries in the Mighty Mites™ Launch Set.

1.

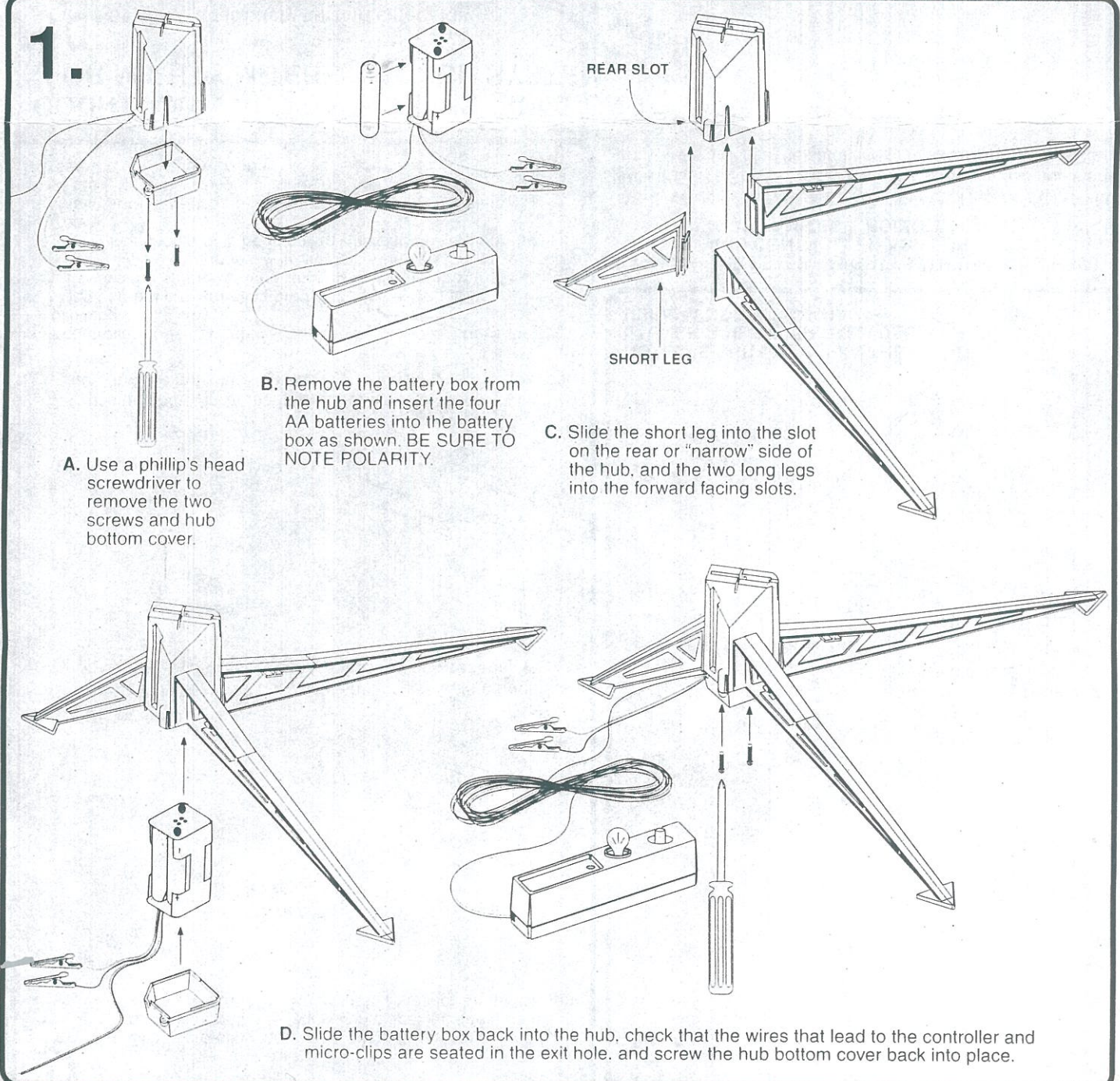

- 2.** A. Clip micro-clips together. Continuity light should not glow without the safety key in place. If it does, do not use your controller. Return it to Estes for a replacement.

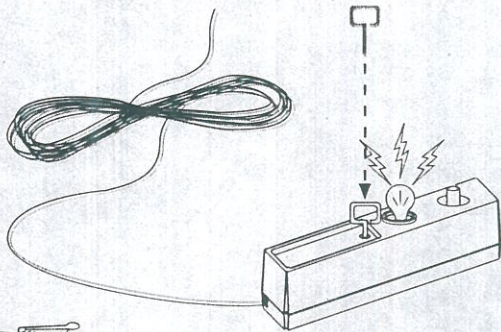

- B. Insert safety key. Continuity light should glow with a bright white light. (A dim yellow light indicates weak batteries.)

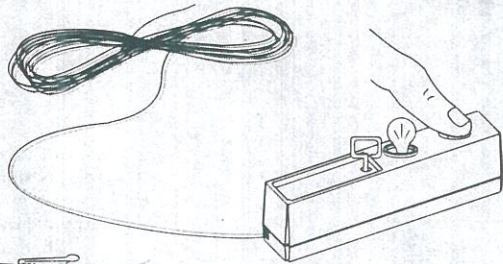

- C. Press and hold down the launch button. The continuity light will go out while button is depressed. Immediately release button.

If controller does not behave as described above, check the following:

- Make sure the micro-clips are firmly clipped together.
- Remove the safety key and reinsert it. (Remember that if your Mighty Mites™ Launch Controller is connected to a rocket, the safety key should only be inserted when no one is near the rocket.)
- Make sure batteries are charged and properly installed.
- If the launch controller still does not function correctly, please see the enclosed warranty.

3.

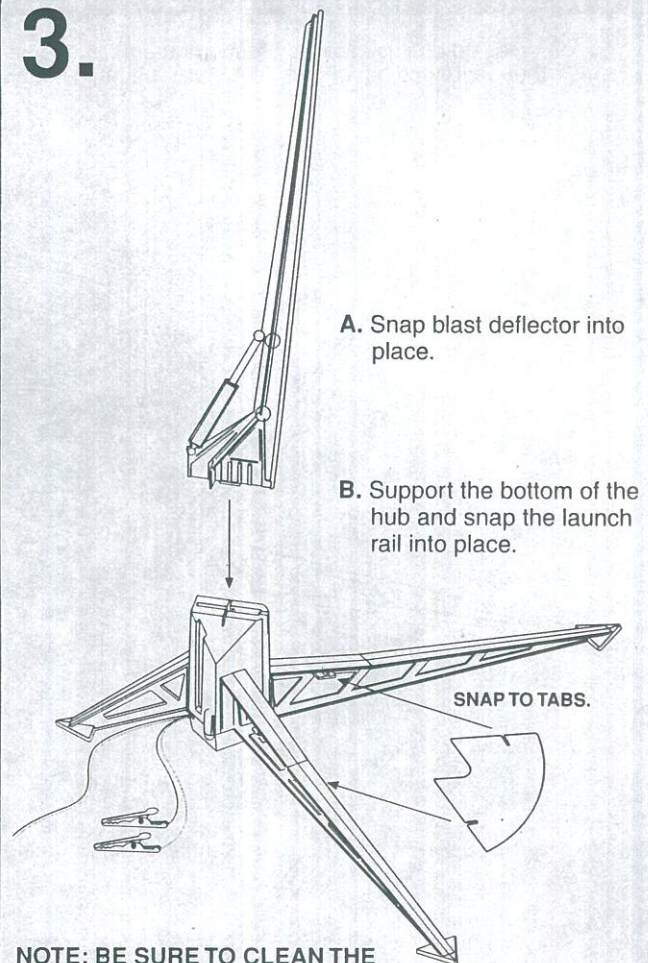

NOTE: BE SURE TO CLEAN THE LAUNCH RAIL AFTER EACH USE USING A SOFT, DAMP RAG.

WARNING: THE ESTES® MIGHTY MITES™ LAUNCH PAD AND CONTROLLER ARE FOR USE WITH MIGHTY MITES™ ROCKETS ONLY!

- Always follow the National Association of Rocketry (NAR) MODEL ROCKETRY SAFETY CODE while participating in any model rocketry activities. The safety code is enclosed with this kit.

COUNTDOWN AND LAUNCH INSTRUCTIONS FOR MIGHTY MITES™ LAUNCH SYSTEM

- 10...** Make absolutely certain safety key is not in launch controller.



- 9...** Slide launch lugs over rail. Make sure rocket slides freely and micro-clips are clean for good electrical contact.

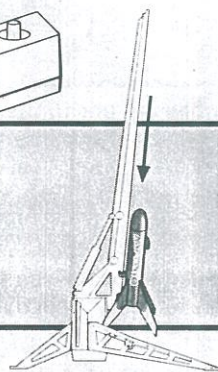

- 8...** Attach micro-clips to the igniter wires. Arrange the micro-clips so they do not touch each other or the metal blast deflector. Attach micro-clips as close to protective tape on igniter as possible.

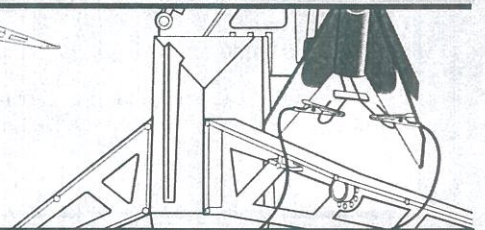

- 7...** Move everyone back from your rocket as far as launch wire will permit (at least 15 feet - 5 meters).

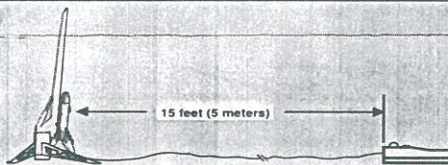

- 6...** Insert safety key to arm the launch controller.

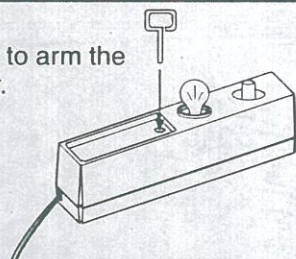

- 5...** Start audible countdown.

**4...3...2...1.....
LAUNCH!**

Push and hold button until engine ignites. For safety, immediately remove safety key from launch controller and keep in your possession.

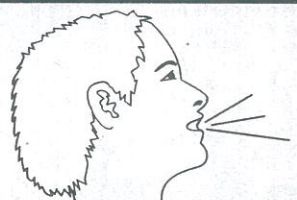

MISFIRES

When an ignition failure occurs, **remove the safety key** from the launch control system and **wait one minute** before approaching the rocket. Remove the expended igniter from the engine and install a new one. Be certain the coated tip is in direct contact with the engine propellant. Broken or chipped coating will not affect the performance of the igniter. Reinstall the igniter plug as illustrated previously. Repeat the countdown and launch procedure.