



The World Leader in Model Rocketry

EST 2163
(9-98) 82158

EXO-SKELL™

FLYING MODEL ROCKET KIT INSTRUCTIONS

BETA™ SERIES

SKILL LEVEL 1

MATERIALS REQUIRED:

PENCIL, RULER, TUBE-TYPE PLASTIC CEMENT, WHITE OR YELLOW GLUE, PIN, HOBBY KNIFE, SMALL PHILLIP'S HEAD SCREWDRIVER.
OPTIONAL: SMALL PAINT BRUSH, SILVER BOTTLE PAINT, MEDIUM PAINT BRUSH, BLACK ACRYLIC PAINT, SOFT CLOTH, LIQUID PLASTIC CEMENT, PAPER TOWELS, BLACK MARKER.

Be sure to read all instructions, test fit all parts, and sand as necessary before gluing.

ALL GLUED AREAS ARE SHADED IN GRAY

PARTS LAYOUT

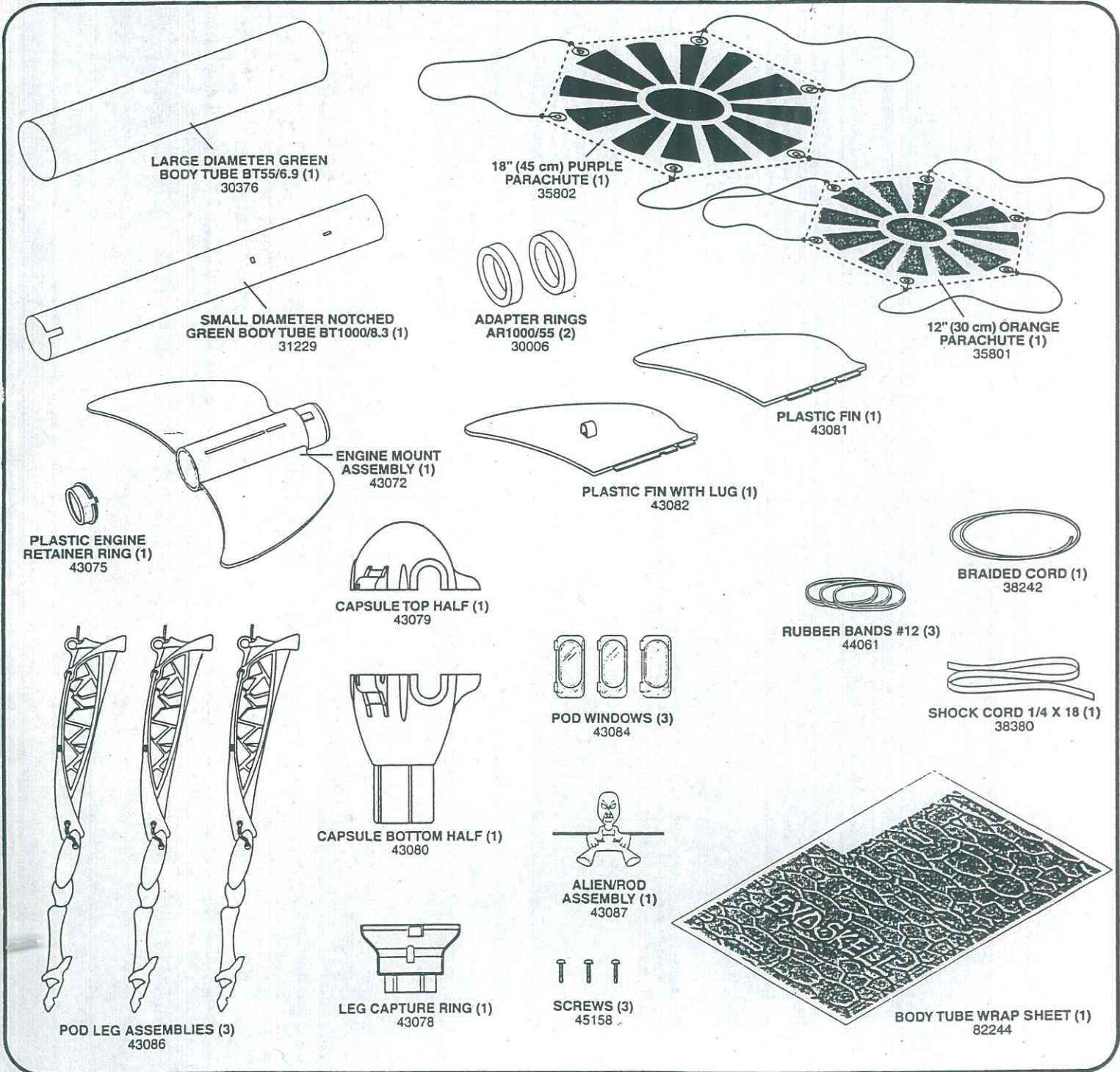

NOTE: BEFORE BEGINNING TO BUILD!

If you want your Exo-Skell™ to look like the one pictured on the box, you will need to begin as follows:

A. Wash all of the plastic parts in mildly soapy water and let dry.

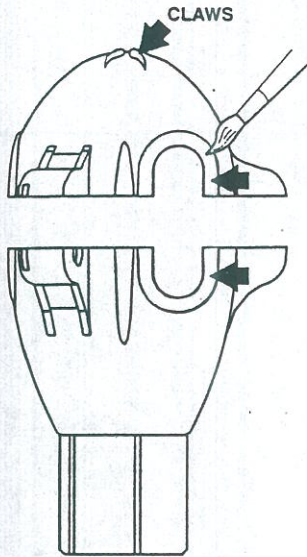

B. Paint silver on the legs, claws, and window frames where shown. Let dry.

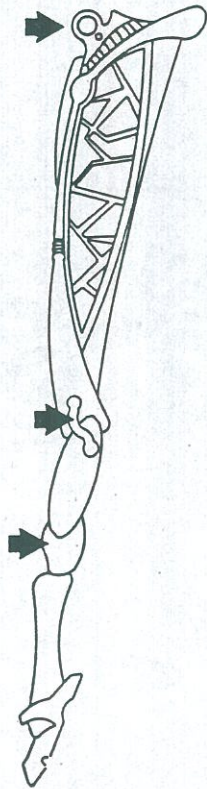

APPLY
BLACK
PAINT



WIPE OFF
HIGH SPOTS
WITH PAPER
TOWEL

C. Have a piece of wet and a piece of dry paper towel on hand. Use a medium sized paint brush to apply black acrylic paint onto the legs, pod halves and fins. While the solution is still wet, gently wipe the raised areas on the plastic pieces with the dry paper towel. Use the wet paper towel to blend and remove unwanted paint. This is a delicate technique that may require several applications. When you are happy with the effect, let dry completely!



D. Use a black permanent marker or black acrylic paint to color the alien's eyes black.

1.



3 TABS ON ROOT EDGE

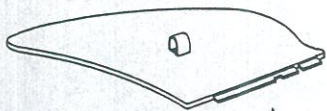

2 TABS ON ROOT EDGE

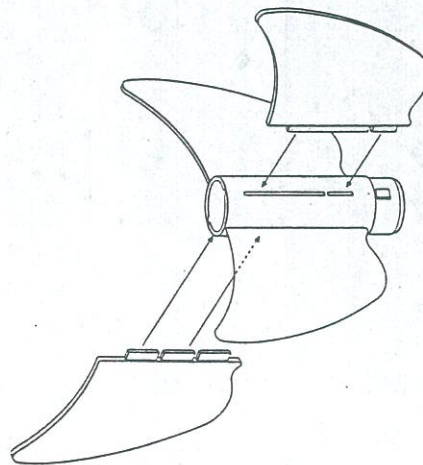

TEST FIT

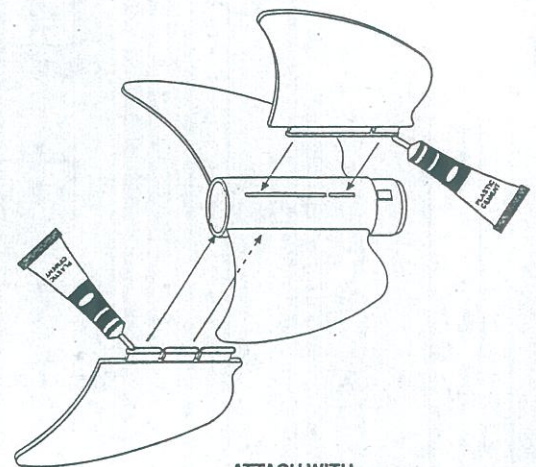

ATTACH WITH
PLASTIC CEMENT

A. Test fit the fins into their slots on the engine mount assembly. Note that the fins have different root edges that key into different slots on the engine mount. Remove fins, apply plastic cement along the root edges, and reapply to engine mount. Set aside to dry completely.

2.

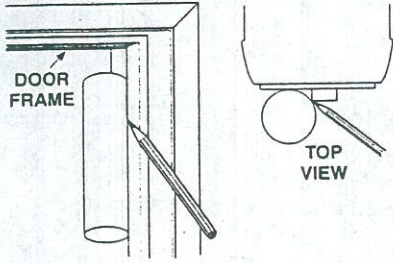

A. Use a door frame to draw a straight line down the length of the large diameter body tube.

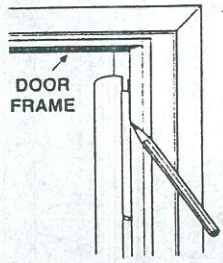

C. Use a door frame to draw straight lines down the length of the small diameter body tube on each side of the notches.

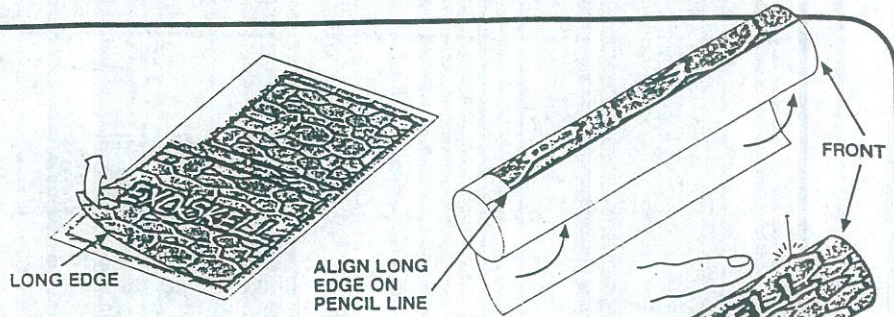

B. Carefully peel the body wrap that says "EXO-SKELL™" off the backing paper, align the edges with the line you drew and with the front end of the tube. Slowly apply around the tube. Use a pin to pop any air bubbles in the wrap, then smooth with finger.

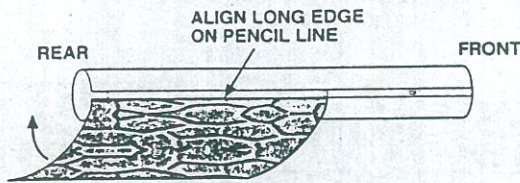

D. Peel the remaining body wrap off the backing paper. Carefully align it with the REAR (end with large notch) of the small diameter body tube and the edge along one of the lines you drew and slowly apply the wrap. Pop air bubbles and smooth the wrap with your finger.



E. Use the two lines to help locate the covered notches, then use a hobby knife to clear them.

3.

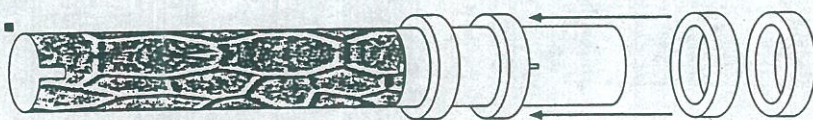

A. Test fit the two adapter rings onto the small diameter tube. If fit is too tight, sand the inside of the rings until rings slide easily onto tube. apply a band of **white or yellow glue** around the **FRONT** end of the tube and slide one of the rings into the glue until it is even with the end of the tube.

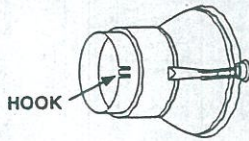

B. Examine the leg capture ring and locate the "hook" on the rear edge.

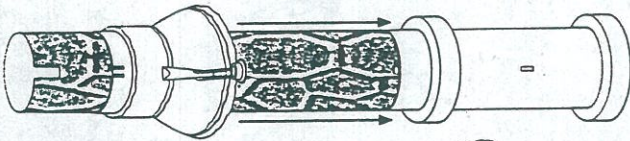

HOOK IN CENTER NOTCH

C. Slide the leg capture ring up the tube so that it "picks up" the adapter ring, and continue until the hook rests in the center notch. **BE CAREFUL NOT TO SLIDE HOOK BEYOND NOTCH!**

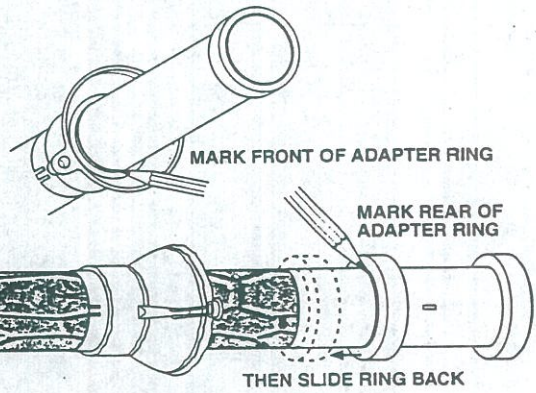

D. Use a pencil to firmly push adapter ring down into leg capture ring. Draw a line around the tube at the front of the adapter ring, slide the leg capture ring back down the tube, draw a line around the tube at the rear edge of the adapter ring and slide the adapter ring down out of the way.

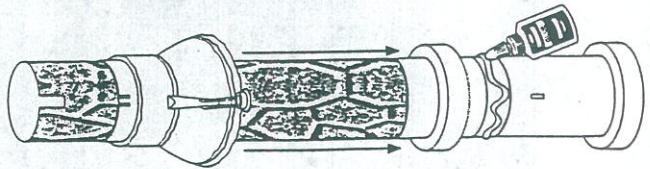

E. Apply a band of white or yellow glue between the two marks, then slide the adapter ring back into place. Let dry.

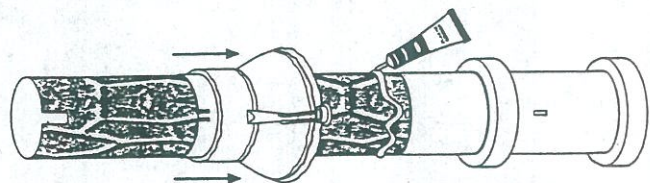

F. Apply a band of **TUBE TYPE PLASTIC CEMENT** just below the notch, and slide the leg capture ring back into place. Let dry.

4.

A. Tie a double knot at one end of the SHOCK CORD.

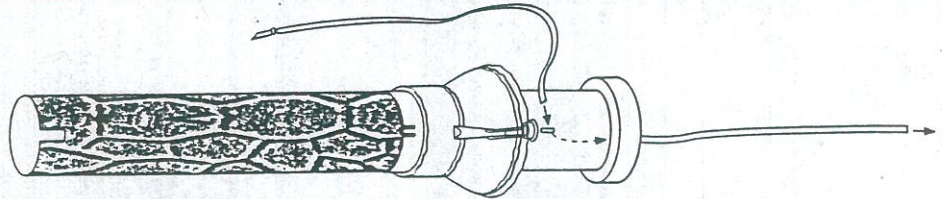

B. Thread the free end of the shock cord through the slot in the small diameter body tube and out the front of the tube until knot rests against the outside of tube.

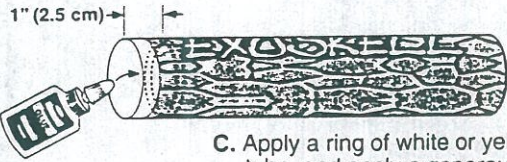

C. Apply a ring of white or yellow glue about 1" (2.5 cm) inside the large diameter tube, and apply a generous amount of white or yellow glue around the adapter ring on the inside of the leg capture ring.

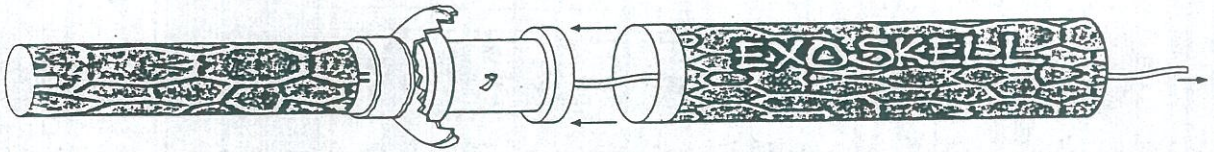
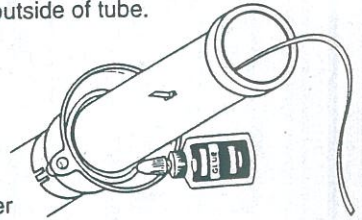

D. Feed the shock cord through the large diameter tube, then slide rear (uncovered) end into the leg capture ring. (The ring will hide the tube section not covered by the body wrap.)

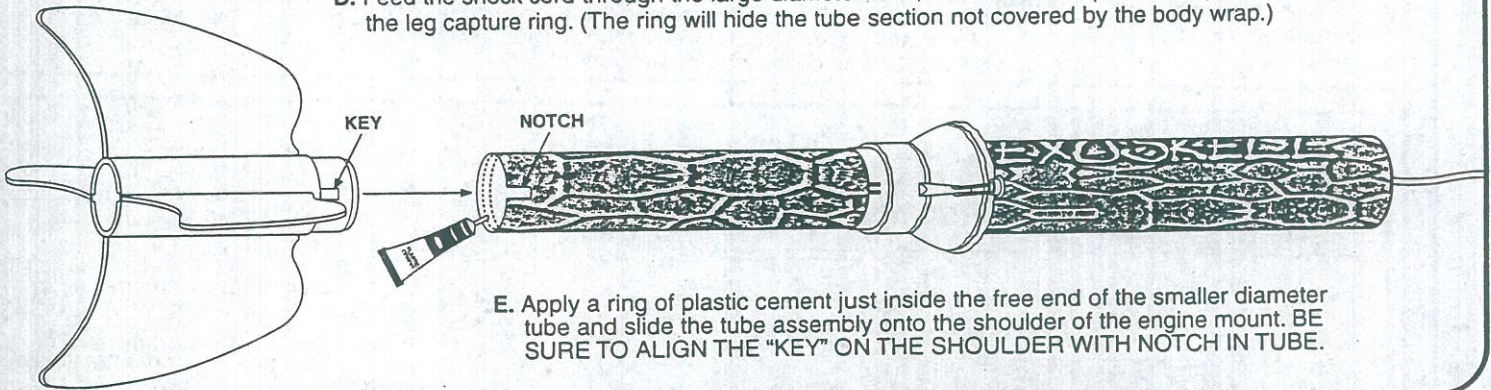

E. Apply a ring of plastic cement just inside the free end of the smaller diameter tube and slide the tube assembly onto the shoulder of the engine mount. BE SURE TO ALIGN THE "KEY" ON THE SHOULDER WITH NOTCH IN TUBE.

5.

A. Tie a triple knot at one end of the braided cord.

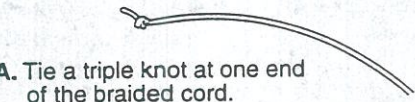

NOTE: You may want to stiffen the free end of the braided cord with white or yellow glue for ease in threading.

B. Thread the free end of the braided cord through the hole in the bottom of the capsule bottom half so that the knot sits inside the capsule.

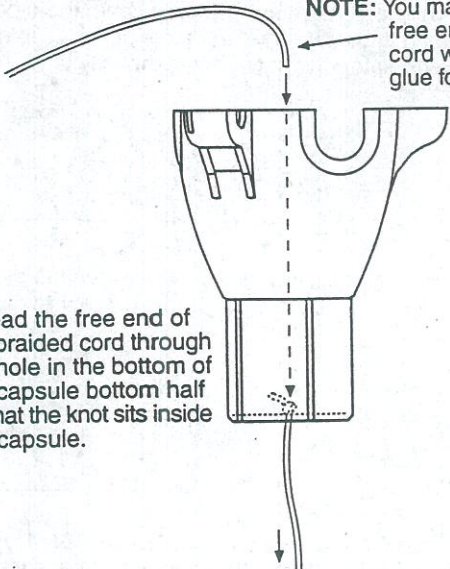

C. Tie a loop at the free end of the braided cord.

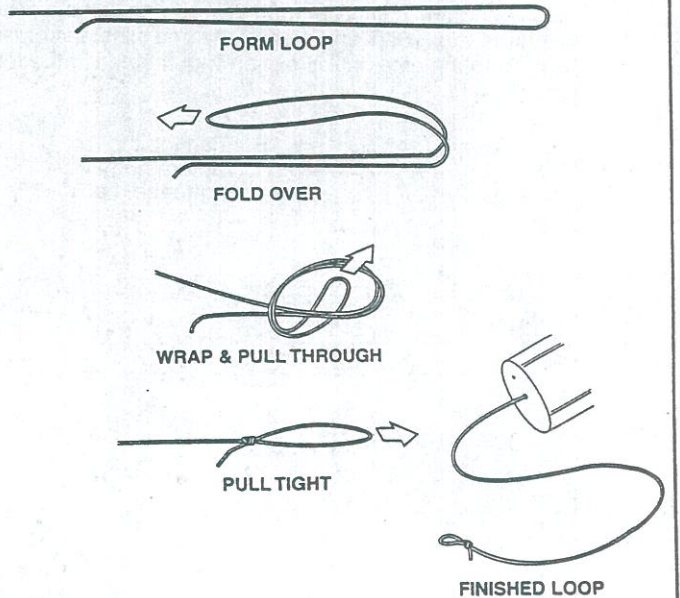

6.

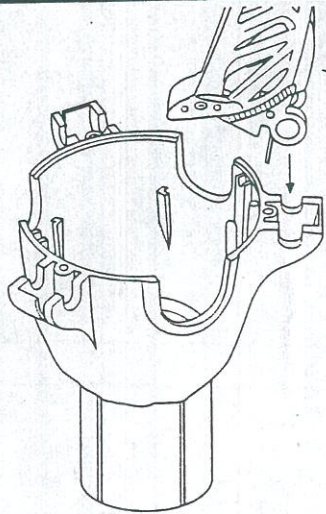

PUSH DOWN AND ROTATE

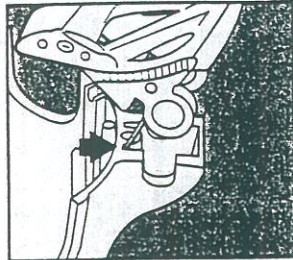

NOTE POSITION OF SPRING END

YOU MAY NEED TO GET HELP FROM AN ADULT FOR THIS STEP

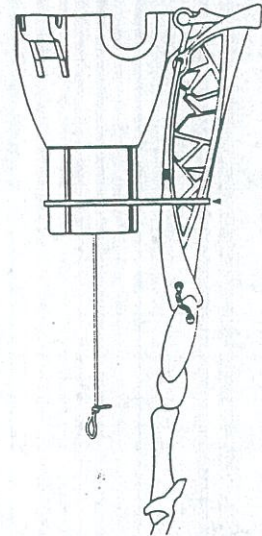

RUBBER BAND

A. Position the free end of the coil spring on one of the pod legs in one of the leg captures on the capsule bottom half. Rotate the leg down and hold in place with a rubber band. BE SURE THE SPRING COIL SPRING IS UNDER TENSION.

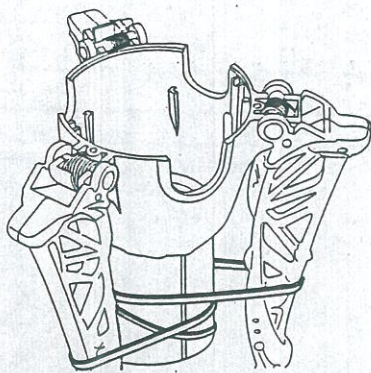

B. Apply the other two pod legs in the same manner.

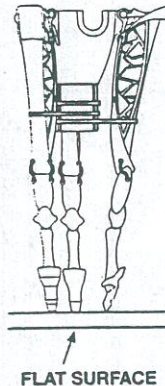

FLAT SURFACE

C. Once the three pod legs are captured, stand the pod on a flat surface. Place the ends of the alien/rod assembly onto the grooves in the capsule.

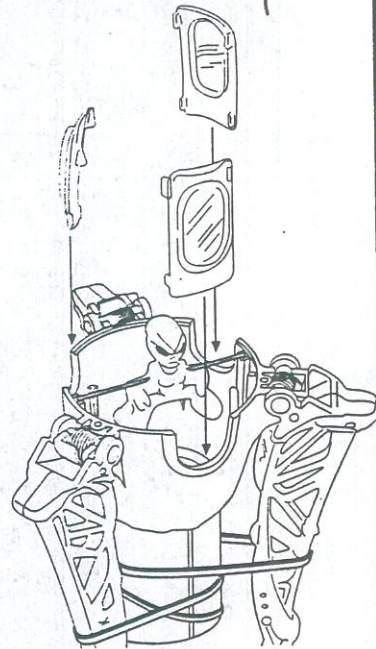
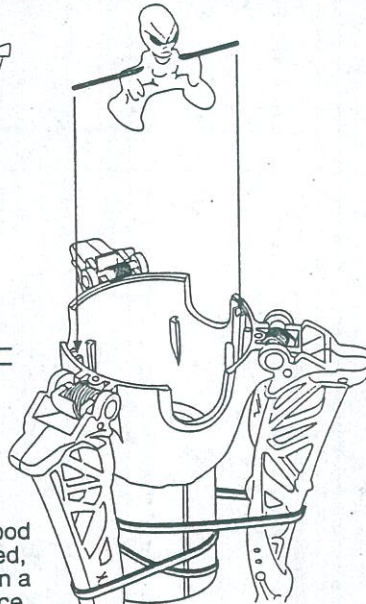

D. Slide the windows into the grooves in the capsule bottom.

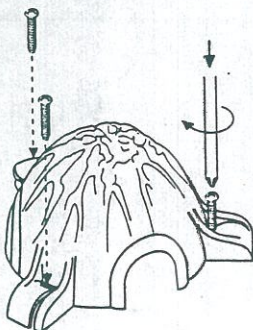

E. Use a phillips head screwdriver to start the screws into the holes on the capsule top half.

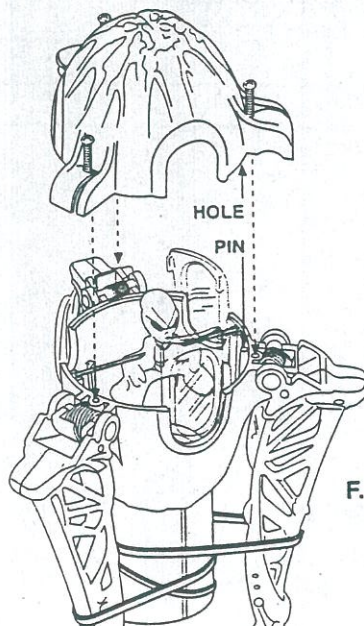

HOLE PIN

F. Align the pin in pod bottom with the hole in pod top and screw the capsule halves together tightly. Once top is secure, carefully release one pod leg at a time. Use caution, as the legs will spring into the "open" position.

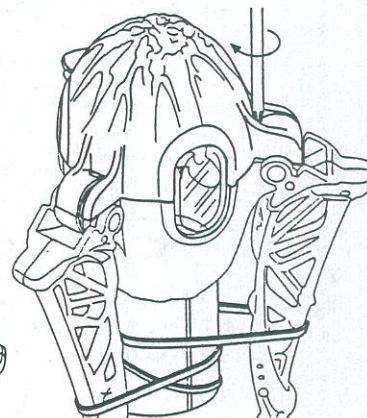

OPTION: Before releasing pod legs, you may wish to apply liquid plastic cement to the pod seams for added strength. Be careful not to get liquid plastic cement near any of the moving joints.

7. MOTHERSHIP PARACHUTE ATTACHMENT

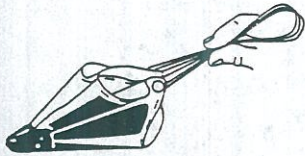

A. Form a loop with the shroud lines attached to the 12" (30 cm) orange Estes® parachute.

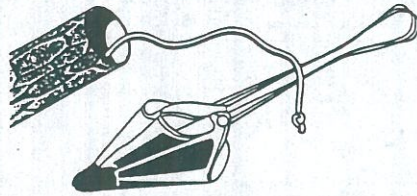

B. Tie a triple knot at the free end of the mothership shock cord, then lay cord over loop.

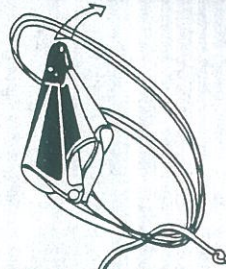

C. Pass parachute through loop.

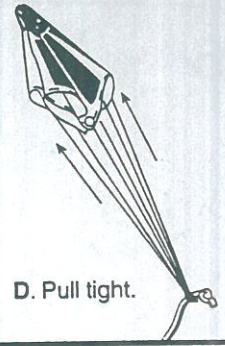

D. Pull tight.

8. ASSAULT POD PARACHUTE ATTACHMENT

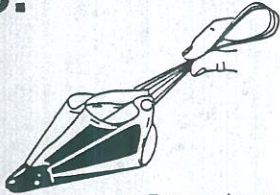

A. Form a loop with the shroud lines attached to the 18" (45 cm) purple Estes parachute and pass through loop at end of braided cord.

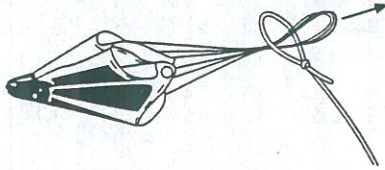

B. Pass parachute through loop.

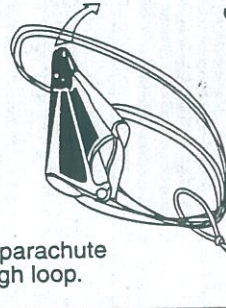

D. Pull tight.

9. PREPARE PARACHUTES FOR FLIGHT

A. Loosely crumple and insert three squares of recovery wadding into mothership tube.

IMPORTANT:

Wadding must be in place and slide freely for rocket to work properly!

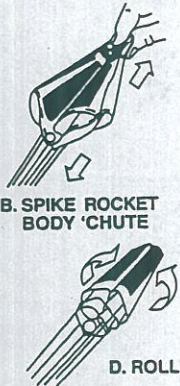

B. SPIKE ROCKET BODY 'CHUTE



C. FOLD

THREE SQUARES OF RECOVERY WADDING

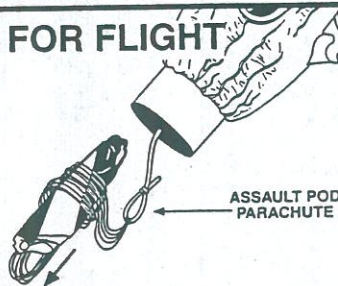

MOTHERSHIP PARACHUTE

E. Wrap shroud lines loosely around mothership 'chute. Insert parachute into rocket. Parachute should slide easily into body tube. If fit is too tight, unfold and repack.

F. Spike, fold, and roll assault pod 'chute, loosely wrap lines around 'chute, and insert 'chute into mothership tube.

G. Slide the assault pod into the rocket body until the legs are captured by the plastic ring as shown.

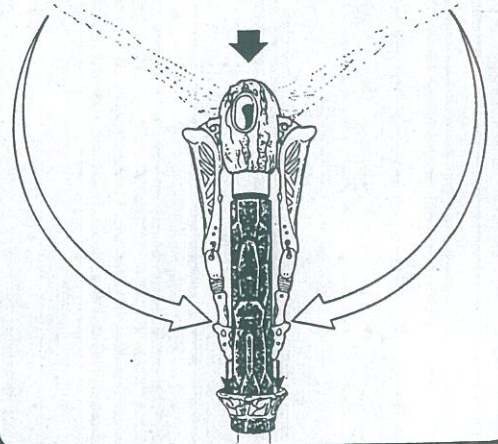

10. PREPARE ENGINE FOR FLIGHT



A. Separate igniter and igniter plug.

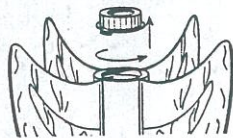

B. Twist off plastic retainer ring at rear of rocket.

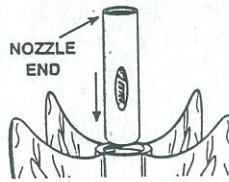

C. Slide engine into rocket body as shown.

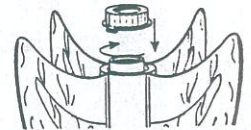

D. Twist plastic retainer ring into locked position to hold engine in place.

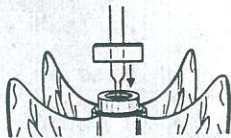

E. Hold rocket upside down, drop in igniter. Igniter must touch propellant.



F. Insert igniter plug.

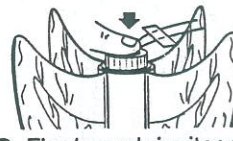

G. Firmly push igniter plug all the way in.

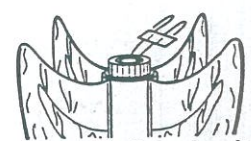

H. Bend igniter wires back as shown.

FLIGHT SEQUENCE

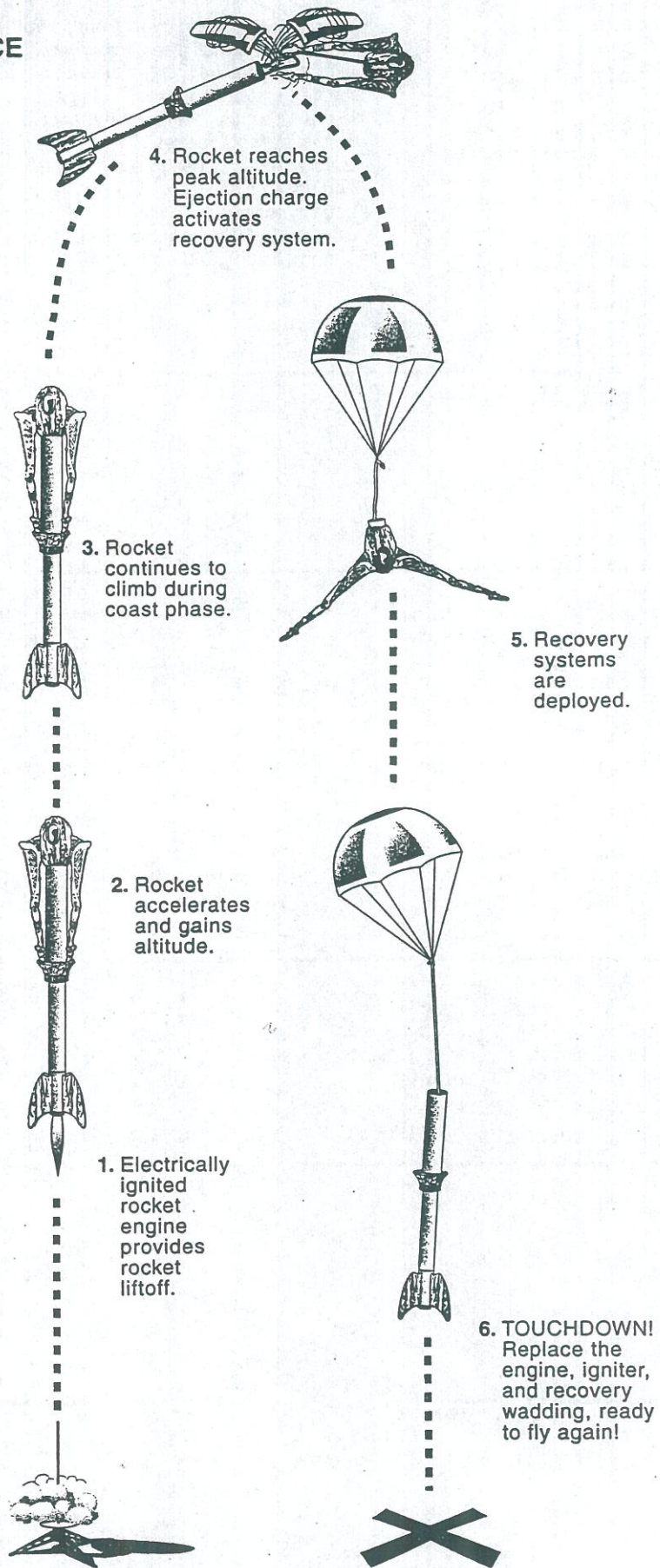

LAUNCH SUPPLIES

To launch your rocket, you will need the following:

- Launch Pad (Estes Porta-Pad® II)
- Launch Controller (Estes Electron Beam® or Laser™ Launcher)
- Recommended Estes Engine: C6-3, C5-3
Use a C6-3 engine for your first flight to become familiar with your rocket's flight pattern.
- Recovery Wadding (EST 302274)
- Igniters and Igniter Plugs (included with Estes engines)

PROJECTED ALTITUDE		
Engine	Feet	Meters
C6-3	215	66
C5-3	230	70

TIPS FOR FLYING YOUR ROCKET

- Choose a large field away from power lines, buildings, tall trees, and low flying aircraft. Try to find a field at least 250 feet (76 meters) square. The larger the launch area, the better your chance of recovering your rocket.
- Launch area must be free of dry weeds and brown grass.
- Launch only during calm weather with little or no wind (wind speed less than 5 mph - 8 kph) and good visibility.
- Don't leave parachute packed more than a minute or so before launch during cold weather (colder than 40° Fahrenheit [4° Celsius]). Parachute may be dusted with talcum or baby powder to avoid sticking.
- Always follow the National Association of Rocketry (NAR) MODEL ROCKETRY SAFETY CODE while participating in any model rocketry activities. The safety code is enclosed with this kit.

COUNTDOWN AND LAUNCH

10...

Safety key must not be in launch controller. The safety cap should be on the launch rod.

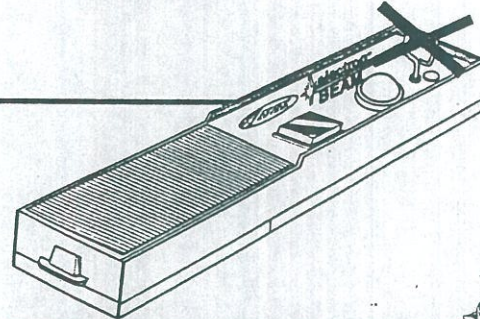

9...

Remove safety cap from launch rod, slide launch lugs over rod. Make sure rocket slides freely and micro-clips are clean for good electrical contact. Make sure the pod legs do not interfere with the launch rod.

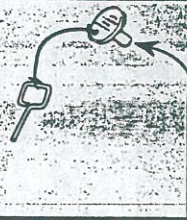

IMPORTANT!
CHECK TO MAKE SURE LEGS DO NOT INTERFERE WITH LAUNCH ROD!

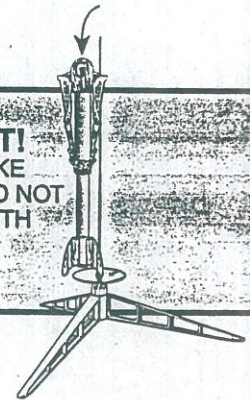

8...

Attach micro-clips to the igniter wires. Arrange the micro-clips so they do not touch each other or the metal blast deflector. Attach micro-clips as close to protective tape on igniter as possible.

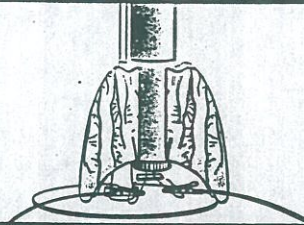

7...

Move everyone back from your rocket as far as launch wire will permit at least 15 feet (5 meters).



6...

Insert safety key to arm the launch controller.

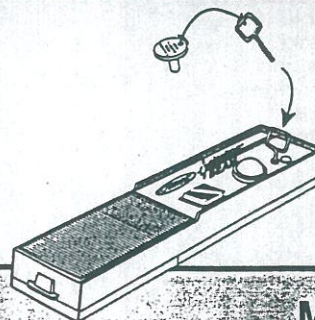

5...

Start audible countdown.

4...3...2...1.....

LAUNCH!

Push and hold button until engine ignites.

For safety, immediately remove safety key from launch controller. Replace safety cap on launch rod.

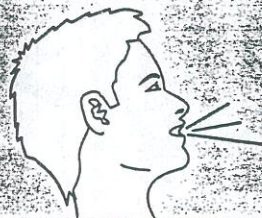

MISFIRES

When an ignition failure occurs, remove the safety key from the launch control system and wait one minute before approaching the rocket. Remove the expended igniter from the engine and install a new one. Be certain the coated tip is in direct contact with the engine propellant. Broken or chipped coating will not affect the performance of the igniter. Reinstall the igniter plug as illustrated previously. Repeat the countdown and launch procedure.