



INCHES
1
2
3
4
5
6
7
8
9
10

BIG YANK

★★★
SKILL LEVEL 1 - RECOMMENDED FOR BEGINNING ROCKETEERS

BEFORE YOU START

Read each step and study the accompanying drawings before doing any of the work called for in that step. Make sure you have all parts and materials. Check off each step as you complete it. Always test-fit parts together before applying glue. It will sometimes be necessary to sand edges of rings, tubes, etc. to obtain proper fit. If you are in doubt about the relative size or location of some parts, refer back to this exploded view drawing for clarification. Adequate glue joints are very important for a flying model rocket. Follow the instructions carefully in this regard.

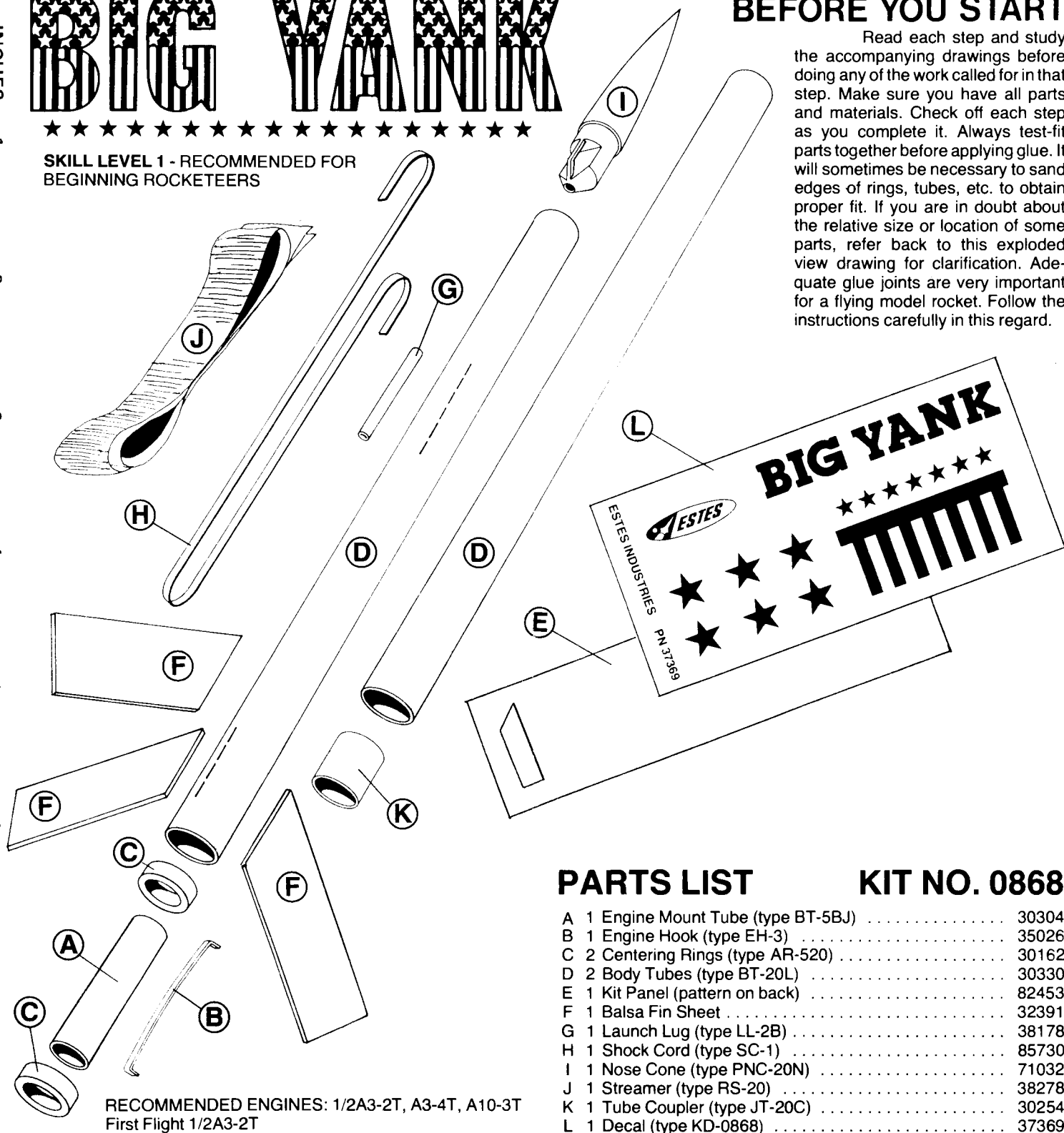

RECOMMENDED ENGINES: 1/2A3-2T, A3-4T, A10-3T
First Flight 1/2A3-2T



A DAMON COMPANY



PARTS LIST

KIT NO. 0868

A	1 Engine Mount Tube (type BT-5BJ)	30304
B	1 Engine Hook (type EH-3)	35026
C	2 Centering Rings (type AR-520)	30162
D	2 Body Tubes (type BT-20L)	30330
E	1 Kit Panel (pattern on back)	82453
F	1 Balsa Fin Sheet	32391
G	1 Launch Lug (type LL-2B)	38178
H	1 Shock Cord (type SC-1)	85730
I	1 Nose Cone (type PNC-20N)	71032
J	1 Streamer (type RS-20)	38278
K	1 Tube Coupler (type JT-20C)	30254
L	1 Decal (type KD-0868)	37369

TOOLS AND MATERIALS

In addition to the parts included in this kit you will need: Scissors, tweezers, pencil, ruler, fine or extra-fine grit sandpaper, sanding sealer, a medium-size modeling paint brush, masking tape, modeling knife with sharp blade, gloss red and blue enamel spray paint and household white glue or resin glue (Elmer's, Titebond, or similar). Other types of glue are not recommended.

ASSEMBLY NOTE: The lower half of this model is painted red and the upper half is painted blue. The model will be constructed in two sections which will be joined together after painting.

ASSEMBLY INSTRUCTIONS

1

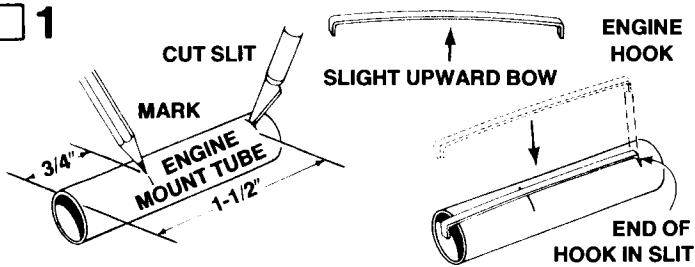

Mark the engine mount tube (part A) at 3/4" and 1-1/2" from one end. Cut a 1/8" long slit at the 1-1/2" mark. Gently bend the engine hook (part B) so that it bows upward very slightly in the middle. (Study the drawing - Don't bend the wrong way.) Insert the engine hook into the slit in the tube.

2

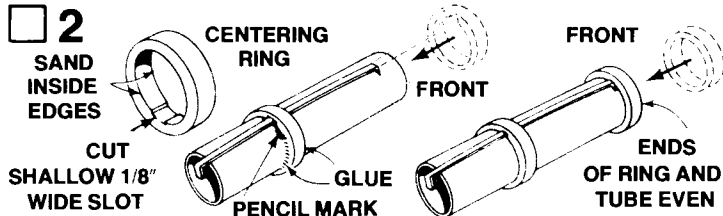

Sand the inside edges of the two centering rings (part C) to remove burrs. The rings should slide easily onto the engine mount tube. Cut a very shallow 1/8" wide slot inside one centering ring so it will fit over the engine hook. Slip the ring onto the front end of the engine mount tube and slide it down to the 3/4" mark. Make sure the engine hook runs straight down the tube, then apply glue to both sides of this adapter ring. Apply glue around the front end of the engine mount tube and slide the remaining centering ring into place (front of ring even with the end of the tube).

3

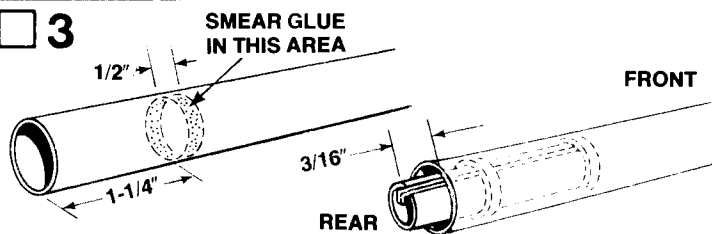

The engine mount unit will be pushed into place so that the rear of the engine mount unit (end with engine hook projecting) is 3/16" beyond the rear of the body tube. Test-fit the engine mount unit into one of the body tubes (part D). Sand if necessary to assure a smooth fit. Apply a ring of glue around the inside of the body tube about 1-1/4" from the end of the tube. Make certain that the engine hook is to the rear and insert the engine mount unit with one smooth motion. Do not pause, or the glue may "lock" with the engine mount unit in the wrong position.

4

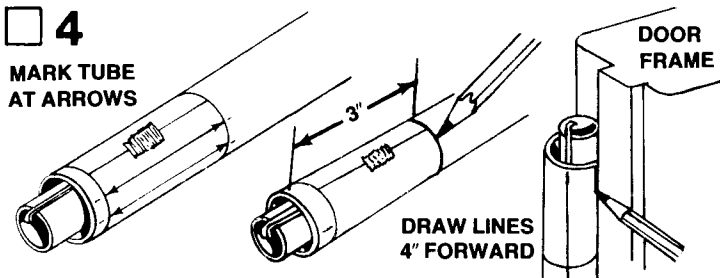

Cut out the tube marking guide from this page of the instructions. Wrap the guide around the body tube, and tape ends together. Place the tube marking guide so that the engine hook will not line up with a fin placement line (arrow point). Mark the body tube at each of the arrow points. Slide the marking guide forward until the edge is 3" from the rear of the body tube. Draw a line around the tube at the 3" mark. Remove the marking guide and draw straight lines connecting each pair of marks. A door frame inside edge can be used as a guide as shown. Extend the fin lines about 4" forward from the rear of the tube. The line for the launch lug should be extended 10" from the rear of the tube.

5

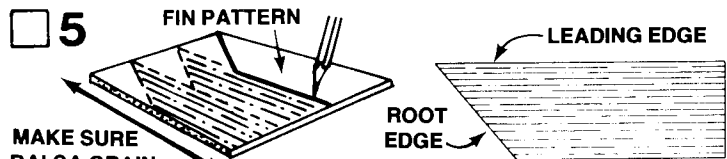

Cut out the fin pattern from the back of the panel (part E). Lay the pattern on the balsa fin stock (part F) with the grain of the wood and the grain shown on the pattern matched. Trace out 3 copies of the fin. Cut out the fins carefully with a modeling knife. Be especially careful to make straight, clean cuts. Sand the sides of the fins so they are flat and smooth. Sand all edges square.

6

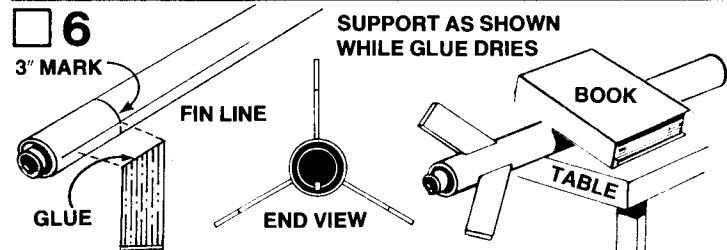

The fins are attached to the body, centered on the fin lines with the front edge of each fin on the 3" mark. Apply a bead of glue to the root edge of one fin. Allow the glue to set for a couple of minutes, then attach the fin to the body. Make sure the fin extends straight from the body. Lay the assembly on a table with the fin pointing up. Lay a book (or similar object) on the front of the body so it won't roll. Allow the glue to dry completely. Attach the remaining fins in the same manner.

7

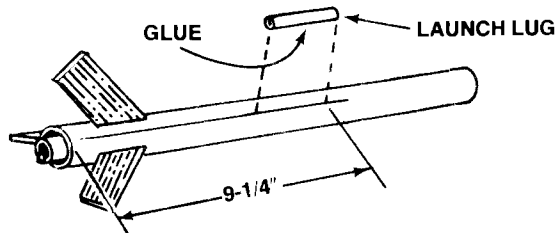

Place a mark on the launch lug line 9-1/4" from the rear of the body. Glue the launch lug (part G) to the body with the front of the lug on the 9-1/4" mark. Make sure the launch lug runs straight along the body.

8

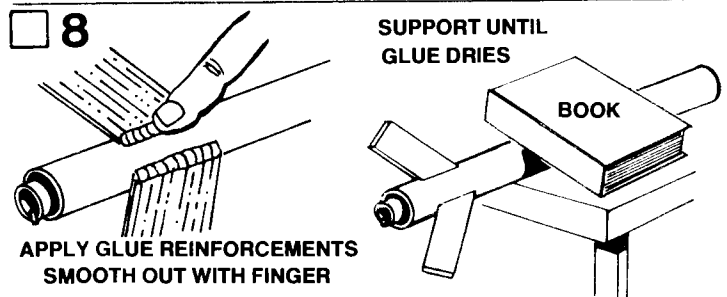

Apply a bead of glue to both sides of a fin-body tube joint. Pull your finger along the joint to smooth out and remove excess glue. Repeat this procedure with the remaining fins and launch lug. Support the model as shown until the glue dries.

FIN MARKING GUIDE

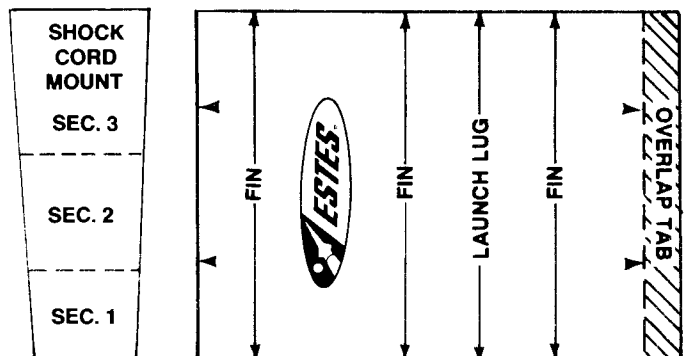

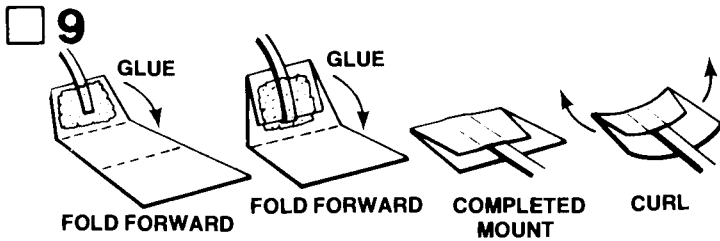

Cut out the shock cord mount from page 2 of the instruction sheet. Fold on dotted lines, then unfold and apply glue to Section 1. Lay the end of the shock cord (part H) into the glue. Fold over and apply glue to the back of Section 1 and the exposed portion of Section 2. Fold again to complete mount. Curl the edges of the mount up so it will match the contour of the body tube and hold with your fingers until the glue sets.

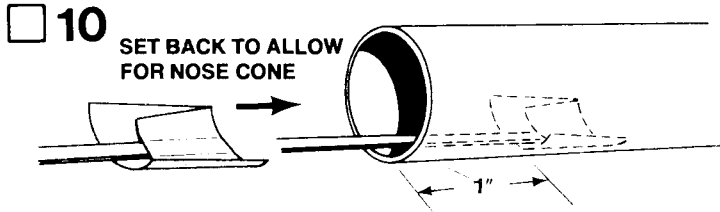

This step begins construction of the upper section. Use the remaining body tube in this step, not the one to which the fins were glued. Use a finger or stick to apply glue to the inside of the front of the body tube, 1" to 2" from the front of the tube. Press the shock cord mount firmly into position in glue far enough from the front edge of the tube to allow clearance for the nose cone to fit into place. To insure a good bond use a stick or your finger to smear a film of glue over the mount and surrounding area in the body tube.

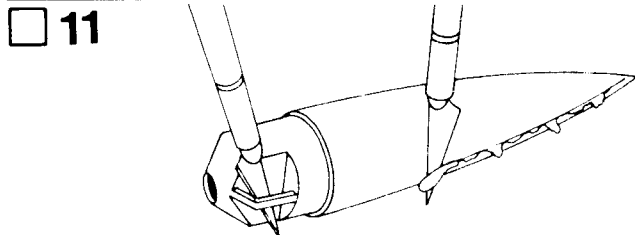

Trim or sand any excess plastic from around the sides of the nose cone (part I). Use a sharp knife to remove any excess plastic from the inside of the molded eyelet at the rear of the nose cone. Wash the nose cone with lukewarm soapy water, rinse well, and dry.

NOTE: Nose cone should separate easily from rocket body tube, but should not be extremely loose. If fit is too tight, sand inside of body tube and shoulder of nose cone with fine sandpaper. If fit is too loose, add a wrapping of transparent tape to the shoulder of the nose cone.

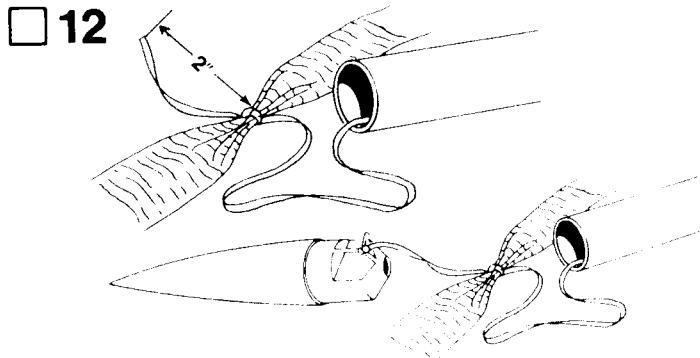

Using a double knot, tie the shock cord around the middle of the streamer (part J) about 2" from the end of the shock cord. Tie the free end of the shock cord to the eyelet on the nose cone (use a double knot). Roll the streamer tightly (see step T-12 on page 4). Pack the streamer and shock cord into the body and socket the nose cone in place.

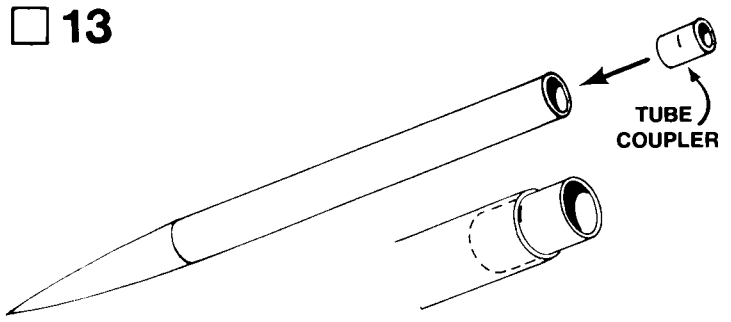

Test fit the tube coupler (part K) into the bottom of the body. Sand the edge of the tube, if necessary, so the coupler will slide in. Mark the coupler in the middle. Apply glue to the inside of the body and slide the coupler into the mark. Wipe away any excess glue. The upper section is now complete.

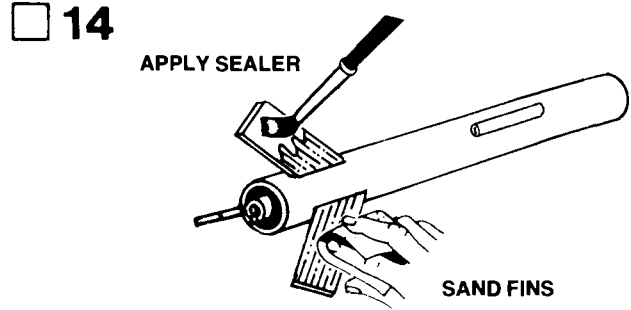

Return now to the lower section. Proceed with this step only after the glue reinforcements on the fins have completely dried. Sealing and sanding the balsa parts reduces drag (higher flights) and greatly improves the model's appearance. This step, however, is not essential to produce a safe model rocket. Apply a coat of sanding sealer to each fin. When the sealer is dry, lightly sand the sealed surfaces. Repeat the sealing and sanding process until the balsa grain is filled and the parts look and feel smooth.

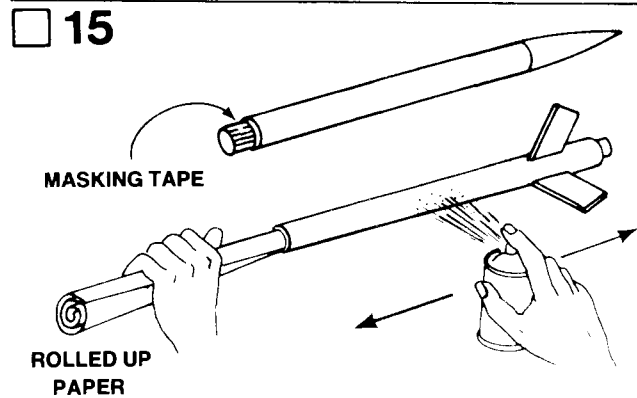

Roll up a piece of paper and insert it into the top of the lower section. This serves as a holder while painting the model and also prevents paint from getting inside the tube where it would interfere with the gluing operation (step 16). Paint the lower section bright red. Follow directions on the spray can. Before painting the upper section, wrap a piece of masking tape around the exposed portion of the tube coupler. Using a piece of rolled up paper as a holder, paint the upper section blue. Let the paint dry at least two hours before proceeding.

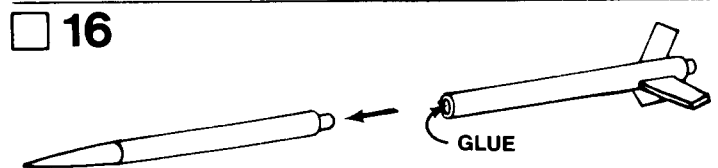

Remove the masking tape from the tube coupler. Apply a bead of glue around the inside of the lower tube. Socket the tube coupler into the tube. Sight along the model to make sure the tubes are straight. Support the model in an upright position while the glue dries.

□ 17 DECAL PLACEMENT



Apply the decals (part L) in the positions shown. (A) Cut only one decal at a time from sheet. (B) Submerge decal in lukewarm water until decal slides on backing paper (usually 15 to 30 seconds). (C) Gently slide decal from backing paper onto model. (D) Move decal into exact position and carefully blot away excess water with a soft cloth. (E) If the decal "sticks" before you have it in position, apply water over the decal with a brush. This will permit the decal to be moved. (F) Smooth out all wrinkles and air bubbles before the decal dries. Apply the roll pattern decal first. The solid white upper portion of the decal will cover the paint separation line. Next apply the name to the side opposite the launch lug. Finally, apply the large stars to both sides of each fin.

LAUNCHING COMPONENTS

To launch your rocket you will need the following items:

- An Estes model rocket launching system
- Flame Resistant recovery wadding (Estes Cat. No. 2274)
- Estes 1/2A3-2T, A3-4T or A10-3T model rocket engines. Use a 1/2A3-2T engine for your first flight.

Be sure to follow the HIAA-NAR* Model Rocket Safety Code when carrying out your model rocket activities.

- *HIAA—Hobby Industry of America
- *NAR—National Association of Rocketry

COUNTDOWN CHECKLIST

T-13

RECOVERY WADDING

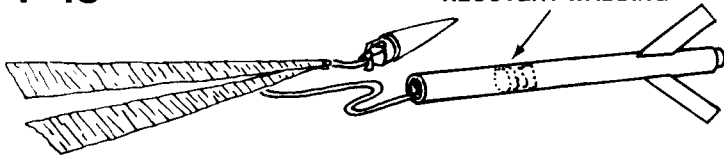

Pack 2 or 3 squares of loosely crumpled recovery wadding into the body tube. Usually this will fill the body tube for a distance equal to about 1-1/2 times its diameter.

T-12

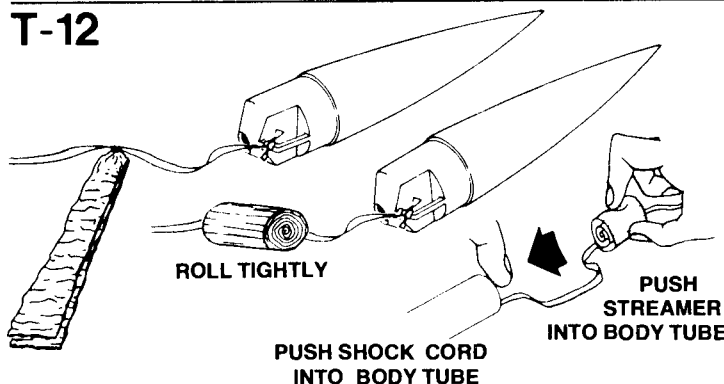

Fold the streamer and roll tightly. Pack the shock cord and streamer into the body and socket nose cone in place. NOTE: If the streamer fits too tightly into the body, remove and re-roll. A too-tight fit could cause an ejection malfunction during flight.

T-11

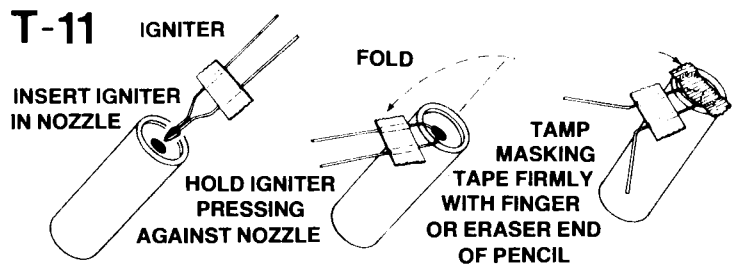

Select an engine and install an igniter as directed in the engine instructions. The engines recommended for use with this rocket are the 1/2A3-2T, A3-4T and A10-3T made by Estes. Use a 1/2A3-2T engine for your first flight.

T-10

ENGINE HOOK MUST LATCH SECURELY

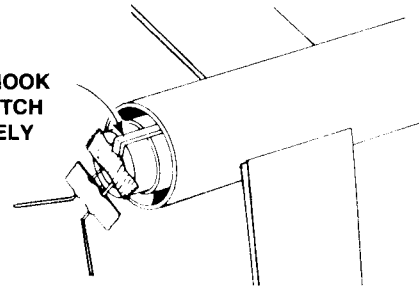

Insert engine into rocket engine mount. Engine hook must latch securely over end of the engine.

T-9

Disarm the launch panel—REMOVE SAFETY KEY!

T-8

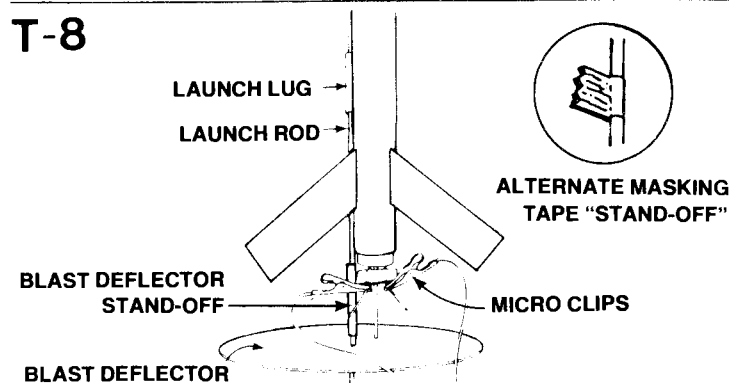

Slide the launch rod through the rocket launch lug. Make sure the rocket slides freely on the launch rod. The rocket must be supported by a "stand-off" to keep the igniter wires from touching the metal blast deflector. If your launch system does not have a stand-off, wrap a piece of masking around the launch rod to support the rocket. Clean the micro-clips and attach them to the igniter wires. Attach the clips as close to the engine as possible. Arrange the clips so they do not touch each other or the blast deflector.

T-7

Clear the launch area. Alert recovery crew and trackers. Check for low flying aircraft and unauthorized persons in the recovery area.

T-6

Arm the launch panel—INSERT SAFETY KEY!

-5-4-3-2-1-LAUNCH!!

Repeat the Countdown Checklist for each flight.

MISFIRE PROCEDURE

Disarm the launch panel. Wait one minute before approaching the rocket on the launch pad. Remove the rocket, clean the igniter residue from the nozzle of the engine, and carefully install a new igniter. Repeat the Countdown Checklist.

Failure of the rocket engine to function properly is nearly always caused by a failure to install the igniter correctly. This failure permits the igniter to heat and burn into two pieces without igniting the engine.

300
DPI

1 2 3 4 5 6 7 8
9 10 11 12 13 14 15 16 17 18 19 20 21 22 23 24 25 26 27 28 29 30 31 32

No. C303SR

PATTERN SECTION

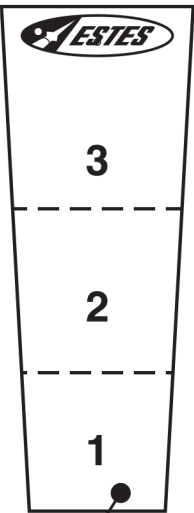

Shock cord mount
Make a copy if you want to keep instructions.

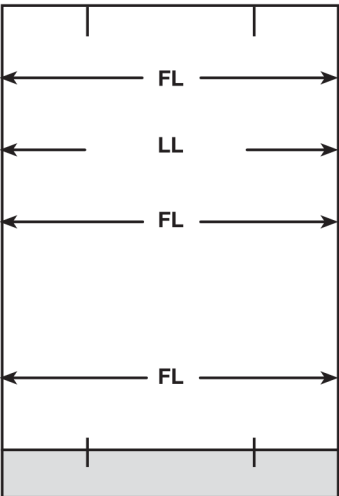

BIG YANK



ESTES INDUSTRIES PN 37369

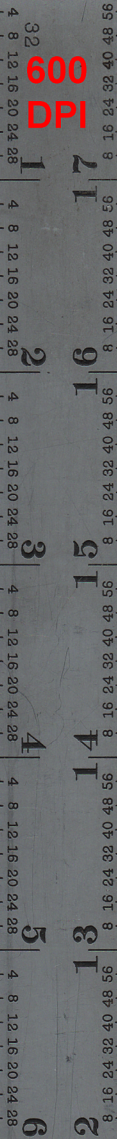

PARTS LIST KIT NO. 0868 - Big Yank								
Quantity	Description	Type	Number	Details1	Details2	Details3	Details4	Comment
1	PAPER BODY TUBE	BT-5J	30304	2" long	0.515" ID	0.541" OD	0.013" wall	Glassine
1	ENGINE HOLDER	EH-3	35026	1.8" long	.125" wide	.025" thick	13mm	Mini
2	CENTERING RINGS	AR-520	30162	.69" OD	.542" ID	0.25" long	Set of 2	Green
2	PAPER BODY TUBE	BT-20L	30330	12" long	0.710" ID	0.736" OD	0.013" wall	Glassine
1	Pattern Sheet	SP-0868	82453	8.5" long	2.5" wide	Index	Cardstock	Scan
1	BALSA FIN STOCK	BFS-20A	32391	1/16" thick	3" wide	3" long	0.0625	Scan
1	LAUNCH LUG	LL-2B	38178	5/32" ID	1/8" rod	2-3/8" long		Mylar
1	Shock Cord	SC-1	85730	18" long	1/8" wide			Rubber
1	PLASTIC NOSE CONE	PNC-20N	71032	2.75" long	.736" dia.	.5" shoulder	Ogive	Injection Molded
1	PAPER STREAMER	RS-20	38278	1" wide	20" long		Red	Crepe Paper
1	STAGE COUPLER	JT-20C	30254	0.650" ID	0.708" OD	0.75" long	fits BT-20	Brown
1	Decal	KD-0868	37369	6" long	3" wide	Wht	Waterslide	Scan

ESTES
A DAWSON COMPANY

Recommended for Ages 10 to Adult.
Adult Supervision Suggested for Those Under
12 Years of Age When Flying Model Rockets.

1 MODEL KIT Paint and Glue not included.
1 MODELE RÉQUIIT Peinture et Colle non comprises.

Flying Model Rocket

BIG YANK

FLYING MODEL ROCKET

SKILL LEVEL 1

1-Beginner 2-Intermediate 3-Craftsman
4-Advanced 5-Expert

- Over Two Feet Tall
- Easy To Build
- Reliable 30" Streamer Recovery
- Plastic Nose Cone
- Quick Release Engine Mount

Length: 26.5 in. (67 cm)
Dia: .736 in. (19 mm)
Weight: .92 oz. (26 g)
Engine Types: 1/2A3-2T (First Flight),
A3-4T, A10-3T

**FLIGHTS
OVER
400
FEET**

This is a...
Please read...
We suggest...
of age when flying model rockets.



ESTES INDUSTRIES
DENVER, CO 80240 USA



#0868

Fly Estes Model Rockets
A Rewarding Hobby For Ages 10 to Adult

ESTES INDUSTRIES
DENVER, CO 80240 USA

This product is designed for use only with Estes model rocket engines.

"Plastic bags can be dangerous. To avoid danger of suffocation, keep this bag away from babies and children."
"Les sacs de plastique peuvent être dangereux. Pour éviter le danger de suffocation, gardez ce sac à distance des bébés et des enfants."



BIG YANK

FLYING MODEL ROCKET

SKILL LEVEL 1

1-Beginner 2-Intermediate 3-Craftsman
4-Advanced 5-Expert

- Over Two Feet Tall
- Easy To Build
- Reliable 30" Streamer Recovery
- Plastic Nose Cone
- Quick Release Engine Mount

Length: 26.5 in. (67 cm)

Dia: .736 in. (19 mm)

Weight: .92 oz. (26 g)

Engine Types: 1/2A3-2T (First Flight),
A3-4T, A10-3T

**FLIGHTS
OVER
400
FEET**

This is a hobby kit requiring assembly. Recommended for ages 10 to adult. Engines, launch system, glue and finishing supplies are not included. Adult supervision suggested for those under 12 years of age when flying model rockets.



A DANCO COMPANY

ESTES INDUSTRIES
PENROSE, CO 81240 USA



#0868