





A SUBSIDIARY OF DAMON
ESTES INDUSTRIES
 PENROSE, COLO. 81240

MARS SNOOPER

KIT NO. 1220

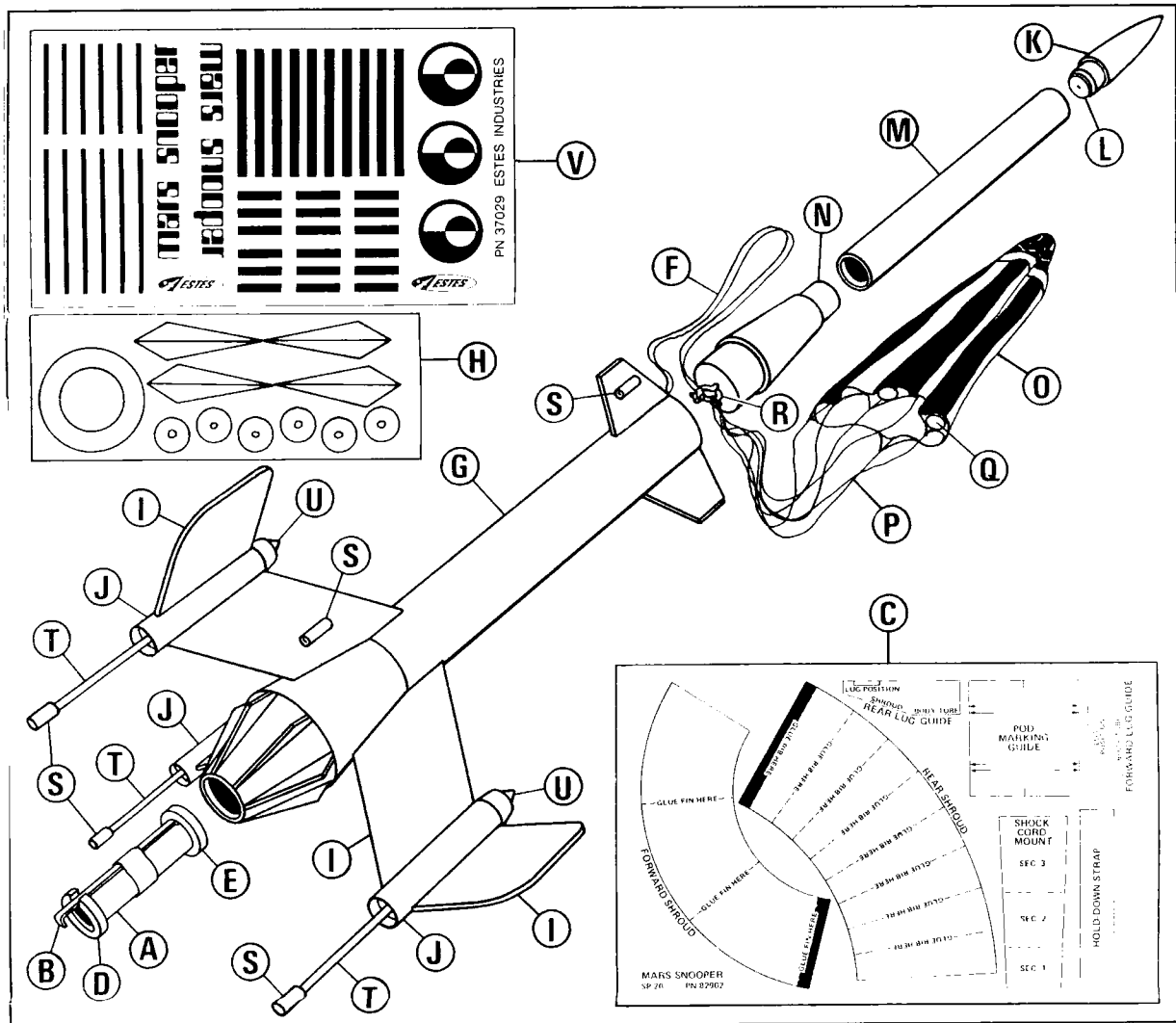

PARTS LIST

A)	1	Engine Mount Tube type BT-20J (2-3/4" long)	30326	L)	1	Nose Cone Weight type NCW-1	38280
B)	1	Engine Hook type EH-2	35025	M)	1	Forward Body Tube type BT-20D (6-1/2" long)	30322
C)	1	Pattern Sheet type SP-20	82902	N)	1	Adapter type TA-2050	70006
D)	1	Split Adapter Ring type AR-2050S	80425	O)	1	Parachute type PK-18A	85566
E)	1	Adapter Ring type AR-2050	30164	P)	1	108" Shroud Line Cord type SLT-108	38239
F)	1	Shock Cord type SC-3	85744	Q)	6	Tape Discs type TD-3F	38406
G)	1	Main Body Tube type BT-50W (9-1/2" long)	30372	R)	1	Screw Eye type SE-2A	38252
H)	1	Die-Cut Card Sheet type TA-20	30054	S)	5	Launch Lugs type LL-2AM (3/8" long)	38176
I)	1	Die-Cut Balsa Fin Sheet type BF-20	32205	T)	3	Wood Dowels type WD-1DE (4-1/2" long)	85903
J)	3	Pod Tubes type BT-5BJ (2" long).	30304	U)	3	Pod Nose Cones type BNC-5BA	70210
K)	1	Nose Cone type BNC-20N	70236	V)	1	Decal Sheet type KD-20	37029

In addition to the parts included in this kit you will need scissors, white glue, a sharp model knife (or single edge razor blade), masking tape, paint, and sanding sealer.

IMPORTANT:

Check to be sure your kit is complete, then read the entire instructions before beginning to assemble your rocket. Check off each step as you complete it.

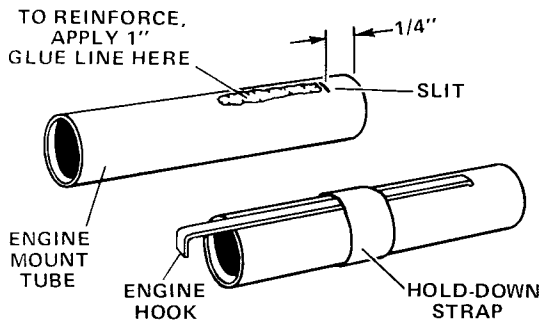

- 1 Cut a 1/8" long slit in the 2-3/4" long engine mount tube (part A), 1/4" from the end as shown. Insert one end of the engine hook (part B) into the slit and position the hook along the tube. Cut out the hold-down strap from the pattern sheet (part C), apply glue to one side, and wrap it tightly around the middle of the tube and engine hook as shown.

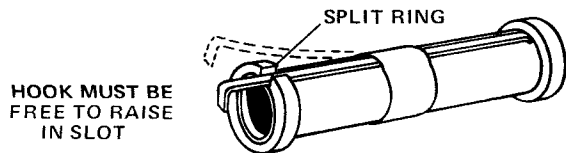

- 2 Glue the split adapter ring (part D) to the engine mount tube even with the rear end (the end with the overhanging hook) so the slot is over the hook. Avoid getting glue in the slot. Glue the other ring (part E) to the front of the engine mount against the end of the hook as shown.

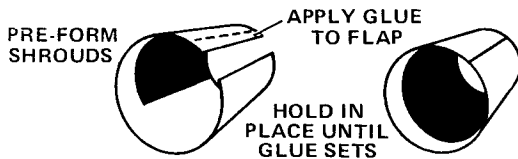

- 3 Cut out both shrouds from the pattern sheet. Cut carefully, following the line exactly. Preform each shroud by wrapping it around itself twice. Apply a small amount of glue to the tab area of one and press the tab into place under the opposite end of the cone. Clamp the joint with your fingers until the glue sets. Repeat with the other shroud.

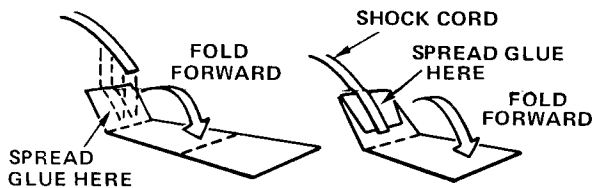

- 4 Cut out the shock cord mount. Pre-fold it on the dotted lines. Apply glue to section 1 and lay the shock cord (part F) into the glue. Fold over and apply glue to the back of the first section and the exposed part of section 2. Lay the shock cord as shown and fold over again. Clamp the unit together with your fingers until the glue sets.

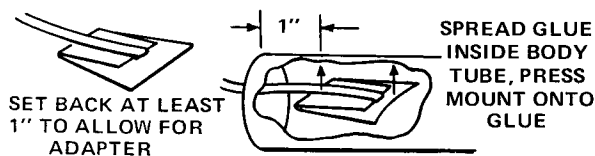

- 5 Apply glue to the inside of the main body tube (part G) at one end over an area about 1" to 2" from the end. The glued area should be the same size as the shock cord mount. Press the mount into the glue as shown and hold it until the glue sets.

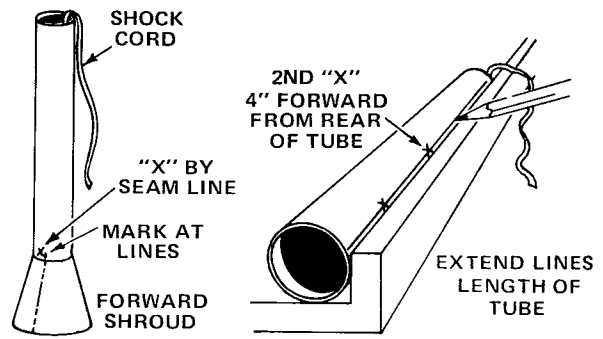

- 6 Slide the forward shroud (the one with three lines) onto the body tube so its large end is at the rear of the body (away from the shock cord). Holding body and shroud vertical on the table top with both body tube and shroud resting on the table as shown, mark the body at each line. Make an "X" by the seam line mark. Remove the shroud and draw straight lines the length of the tube through each mark. Use the edge of a drawer or door frame as a guide to keep the lines straight on the body. Make a second "X" by the same line, 4" from the rear of the body.

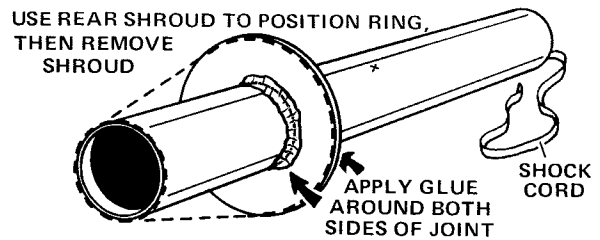

- 7 Punch out the large shroud ring from the die-cut card sheet (part H). Slip the ring onto the rear end of the body tube. Slide the rear shroud (the one with 8 lines) onto the rear of the tube and slide the ring back into the end of the shroud until ring and shroud fit together perfectly with the small end of the shroud even with the end of the body tube. Remove the shroud and apply a line of glue around both sides of the joint between ring and tube.

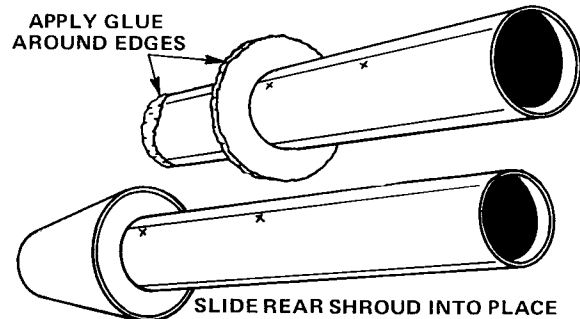

- 8 Apply glue to the outer edge of the ring and around the rear of the body tube. Slide the rear shroud into place, making sure ring is seated inside shroud all around and that end of shroud is even with end of body tube.

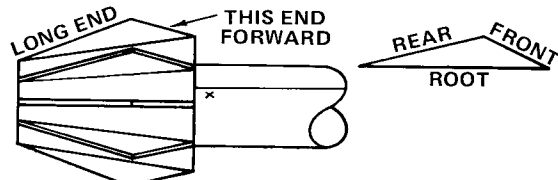

- 9 Punch out the 8 "cooling fins" from the die-cut card. Compare with the drawing-note that the longer end of each fin is nearest the back end of the rear shroud. Glue the cooling fins in place on the alignment lines as shown.

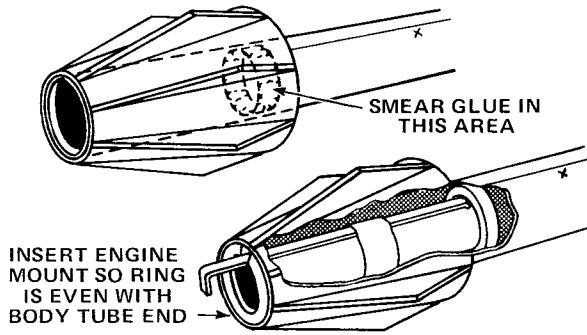

□ 10 Smear glue around the inside of the rear of the body tube to cover an area about 2" to 2-1/2" from the end of the tube. Immediately insert the engine mount unit, being careful to turn it so the engine hook will project from the tube. Push the engine mount in with one smooth motion until the ends of the tubes (and the split ring) are even.

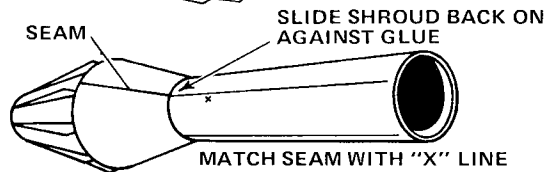
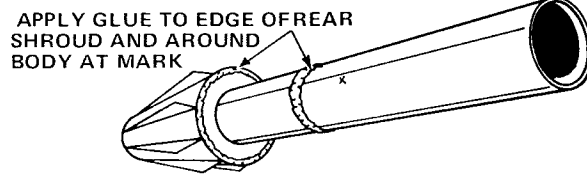
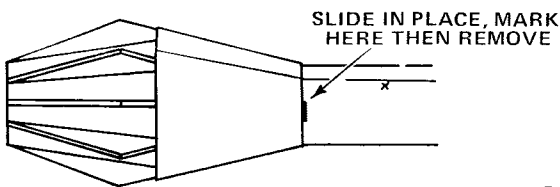

□ 11 Slide the forward shroud onto the body tube and into position against the rear shroud. Mark the main body at the front edge of the shroud. Slip the shroud forward and turn it so its seam line is on the line marked "X". Apply a line of glue around the front end of the rear shroud and around the body at the mark. Slide the forward shroud back into place, making sure it is seated against the rear shroud all around and that the seam matches the "X" line perfectly.

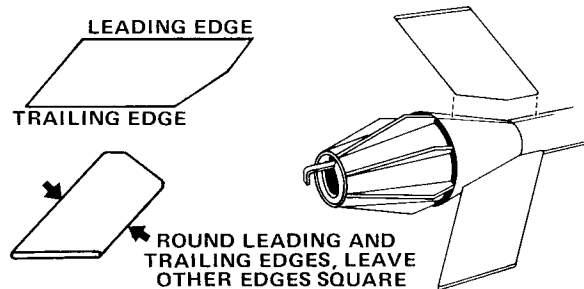

□ 12 Sand both sides of the die-cut balsa sheet (part I) to smooth surfaces and to make part removal easier. Carefully remove the main fins from the sheet. Sand the leading and trailing edges of the fins round; leave the other edges square. Rub a line of glue into the root edge of each fin and let dry. Position and glue the fins to shroud and body on the alignment lines. Adjust the fins so they project straight away from the body tube. Do not lay the rocket on its fins until the glue is completely dry.

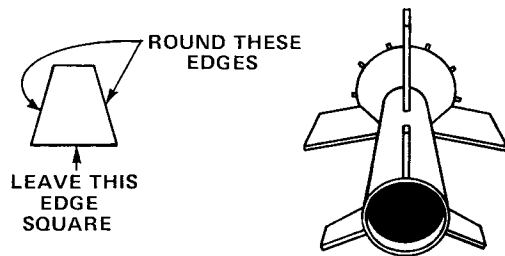

SIGHT DOWN TUBE TO MAKE SURE FORWARD FINS ARE IN LINE WITH MAIN FINS

□ 13 Remove the forward fins from the balsa sheet and sand all edges except the root edges until round. Glue the forward fins to the front of the body on the alignment lines, making sure they are even with the tube end and perfectly in line with the main fins.

MARK TUBE AT ALL 8 ARROW POINTS

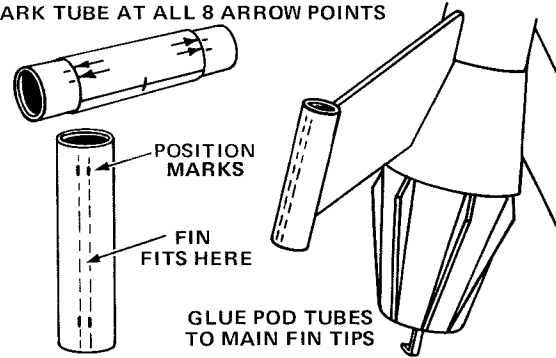

□ 14 Cut out the pod marking guide from the pattern sheet. Wrap the guide around one pod tube (part J) and mark the tube at each point. Repeat with the other two pod tubes. Glue the pod tubes to the main fins with the front edge of each tube even with the front edge of its fin. Make sure the fin is positioned on the alignment marks on the tube.

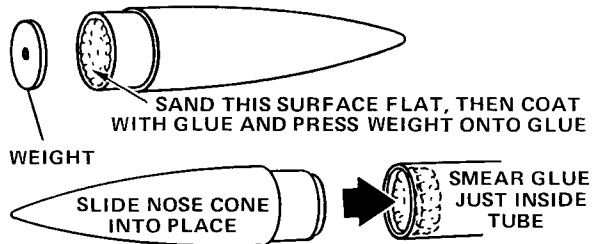

□ 15 Sand the back end of the main nose cone (part K) until flat. Apply a layer of glue to the back of the nose cone and press the nose cone weight (part L) onto the glue. Apply a line of glue around the inside of one end of the forward body (part M), 1/8" to 1/4" from the end of the tube, and insert nose cone and weight into place. Support the assembly, nose down, until the glue is dry. Glue the adapter (part N) to the other end of the tube.

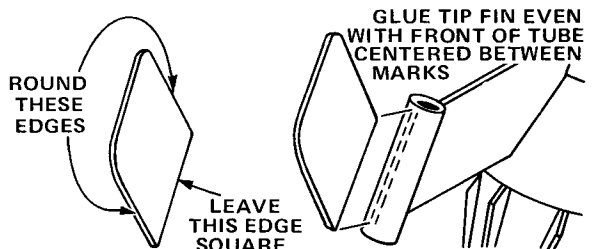

□ 16 Remove the tip fins from the balsa sheet and round all edges except the root. Glue the fins to the pod tubes on the alignment marks. The front edge of each fin should be even with the front of its tube. Set the rocket on its nose while the glue dries.

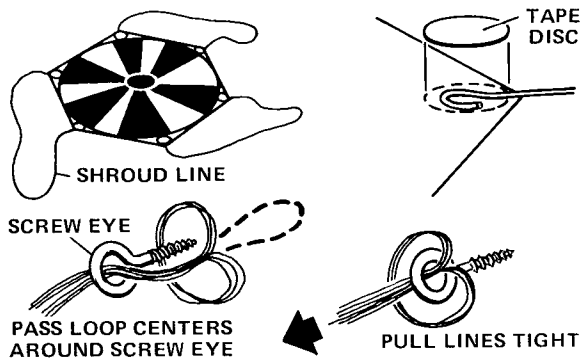

17 Cut out the parachute (part O) on its edge lines. Cut three 36" lengths of shroud line (part P). Attach line ends to top surface of parachute with tape discs (part Q) as shown. Pass shroud line loops through screw eye (part R). Pass eye through loop ends and draw lines tight against screw eye. Set knot with a drop of glue.

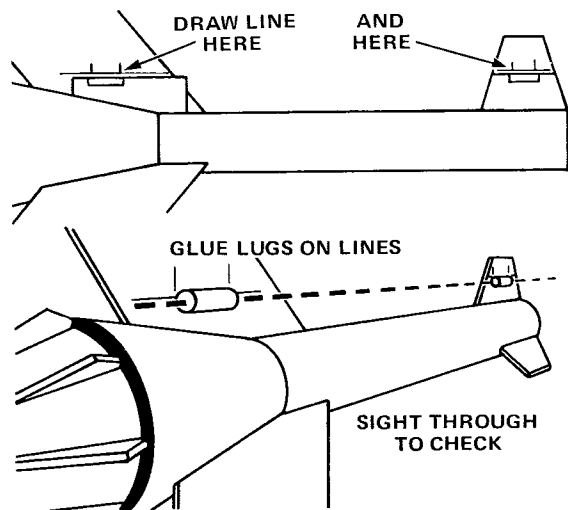

18 Cut out the launch lug alignment guides from the pattern sheet. Mark a matching main fin and forward fin. Glue a launch lug (part S) in place on each line. Sight through the lugs to be sure they are straight and clear the shroud.

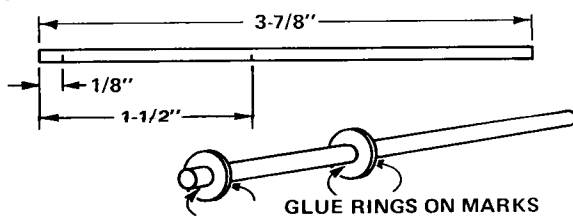

19 Assemble the landing legs. Cut the three dowels (part T) to a length of 3-7/8" each. Mark each dowel 1/8" and 1-1/2" from one end. Punch out the small rings from the die-cut sheet and glue the rings to the dowels at the marks as shown. Make sure the rings are straight on the dowels.

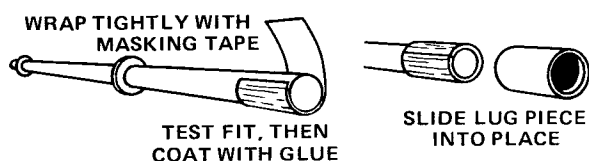

20 Cut three strips of masking tape 3/8" wide and 1-1/4" long. Wrap a strip around the end of each dowel. Test fit a launch lug over the tape; if it is too tight remove tape, a 1/16" at a time, until the lug fits smoothly on all three dowel ends. Smear glue over the tape and glue a lug in place on each dowel.

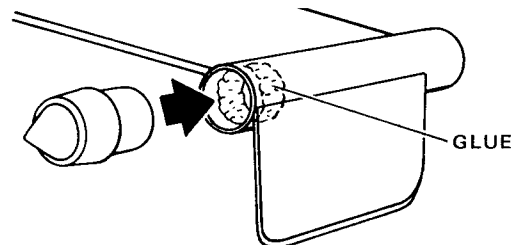

21 Glue the pod cones (part U) in place. Apply a line of glue just inside the forward end of each pod tube and slide the cones into place.

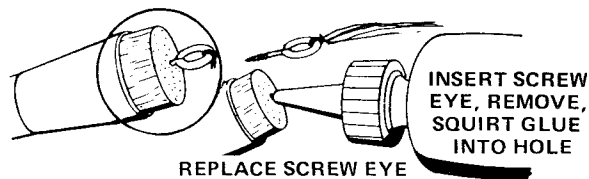

22 Insert the screw eye into the base of the adapter. Remove the screw eye and squirt glue into the hole. Re-insert the screw eye into the hole.

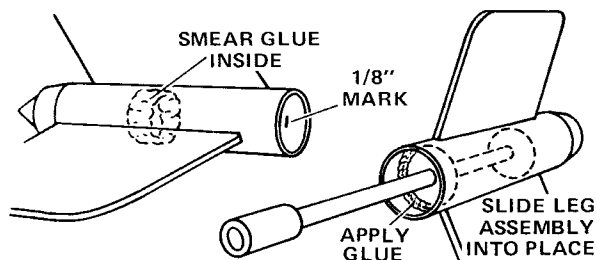

23 Mark the inside of each pod tube 1/8" from the rear end. Smear a line of glue around the inside of a tube as far in as possible and slide a landing leg assembly in until the rear ring is even with the mark. Repeat with the other two pods. Apply a line of glue to the joint between rear ring and tube on each pod.

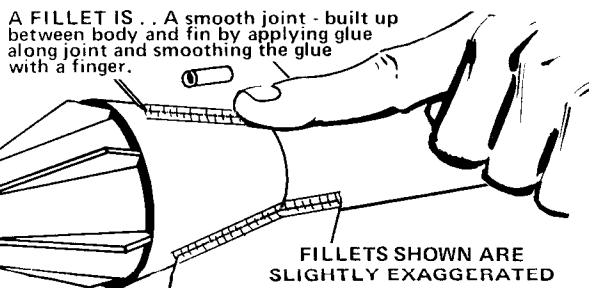

24 Apply a glue fillet to each fin joint. Holding the rocket horizontally, apply a line of glue to the joint and smooth it out with your finger. A strong, but smooth, reinforced joint between the main fins and the body and shroud is especially important. Support the rocket horizontally until the glue dries.

TIE SHOCK CORD TO SCREW EYE

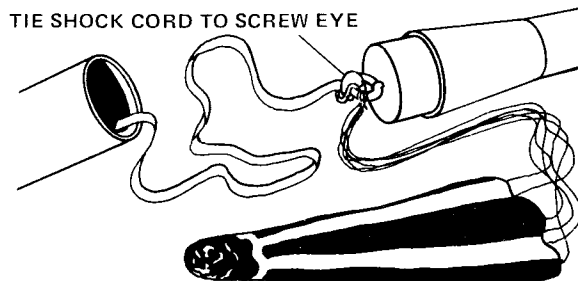

25 Tie the free end of the shock cord to the screw eye. Fold the parachute and pack it into the body along with shroud lines and shock cord. Slide the adapter on the nose assembly into place in the main body.

- 26** When all glue is completely dry, prepare the model for painting. Sand all balsa surfaces until smooth. Apply two or more coats of sanding sealer to the exposed wood surfaces. Sand lightly with extra fine sandpaper between coats. Repeat until pores are filled and surfaces look and feel smooth.

(B) COVER DOWEL BY TAPING PAPER AROUND IT

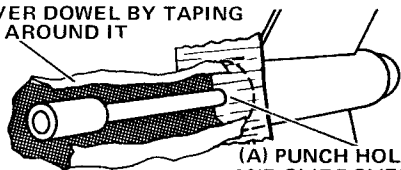

(A) PUNCH HOLE IN TAPE AND SLIDE OVER DOWEL, PRESSING AGAINST END OF POD TUBE

- 27** For best results, give the entire rocket a spray base coat of white. Be sure to paint the landing legs and the inside rear of the pods white. When the white paint is completely dry, mask off the inside rear of the pods and the landing legs. Paint the entire rocket red.

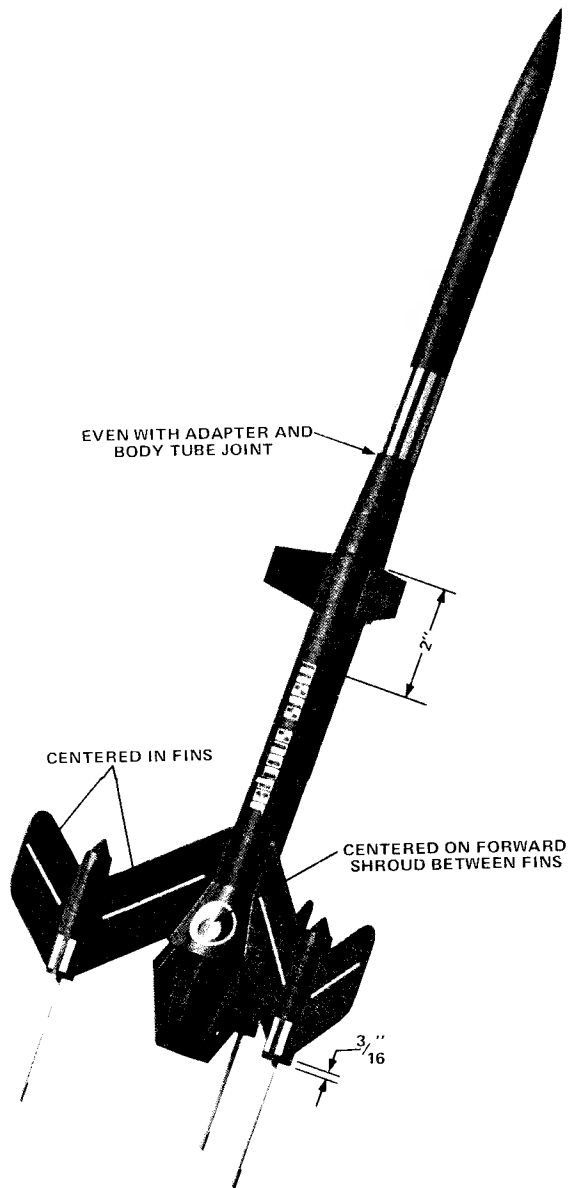

- 28** When all paint is dry, remove the masking and apply decals (part V). Cut out a decal section, dip it in lukewarm water for 10 seconds, and hold it until it uncurls. Slip the decal off the backing sheet and onto the model. Blot excess water away. For best results, let the model dry overnight and apply a coat of clear spray to protect the decals.

COUNTDOWN CHECKLIST

- 14** Pack four squares of loosely crumpled recovery wadding into body tube.

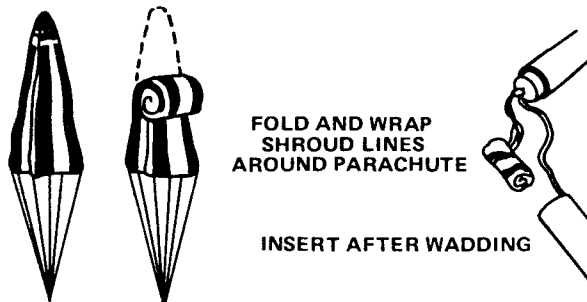

- 13** Fold the parachute into a triangular shape. Roll 'chute tightly as shown and wrap shroud lines around it. If 'chute is too large, unroll and repack until it slides easily into rocket. A fit that is too tight may prevent parachute from ejecting properly.

NOTE: DO NOT pack parachute until you are actually ready to launch. For maximum parachute reliability, lightly dust 'chute with ordinary talcum powder, especially in cold weather.

- 12** Pack shock cord neatly into rocket.

Slide adapter into place. Adapter should separate easily from rocket body tube, but should not be extremely loose. If it is too tight, sand inside of body tube and shoulder of adapter with extra fine sandpaper.

If adapter is too loose, add a wrapping of transparent tape or masking tape to the shoulder of the adapter.

- 11** Select an engine and install an igniter as directed in the engine instructions. Engines recommended for use with this rocket are A8-3, B4-2, B6-4, and C6-5.

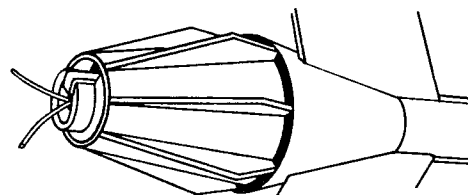

- 10** Insert engine into rocket. Engine hook must latch securely over end of engine.

- 9** Disarm the launch panel--remove safety key.

- 8** Place rocket on launch pad, making sure rocket slides freely on launch rod. Clean the microclips and attach them to the igniter.

- 7** Clear the launch area, alert recovery crew and trackers. Check for low flying aircraft and unauthorized persons in the recovery area.

- 6** Arm the launch panel--insert safety key.

5 - 4 - 3 - 2 - 1 LAUNCH !!

MISFIRE PROCEDURE

Occasionally the igniter will heat and burn in two without igniting the engine. This is almost always caused by a failure to install it correctly. Disarm the launch panel, remove the model, clean the igniter residue from the nozzle, and install a new igniter. Follow the launching procedure again.

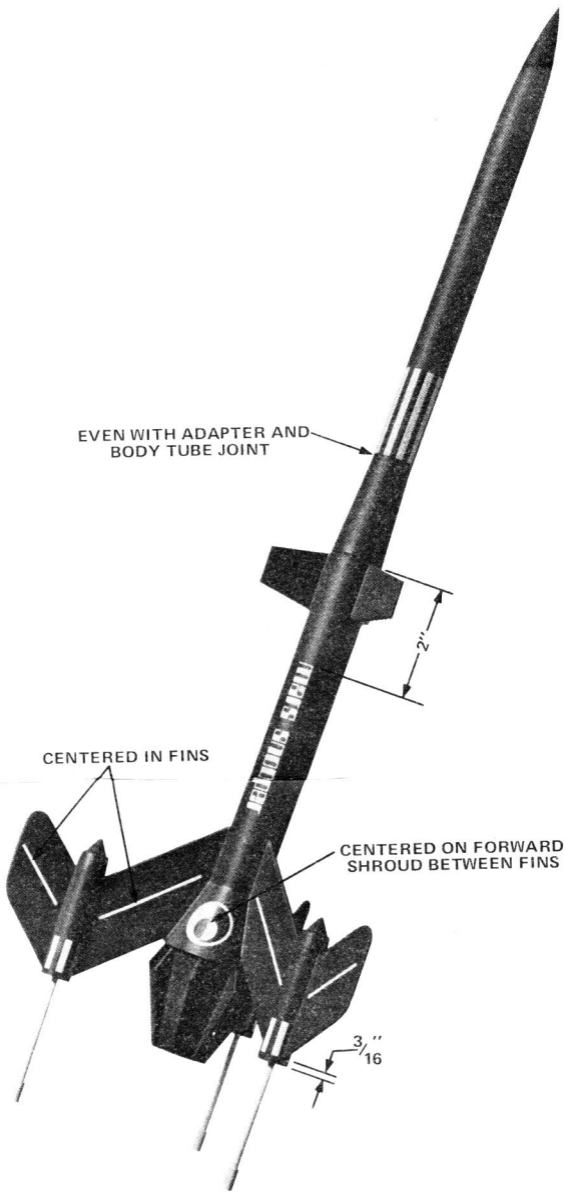

EVEN WITH ADAPTER AND
BODY TUBE JOINT

2"

CENTERED IN FINS

CENTERED ON FORWARD
SHROUD BETWEEN FINS

$\frac{3}{16}$ "

300
DPI

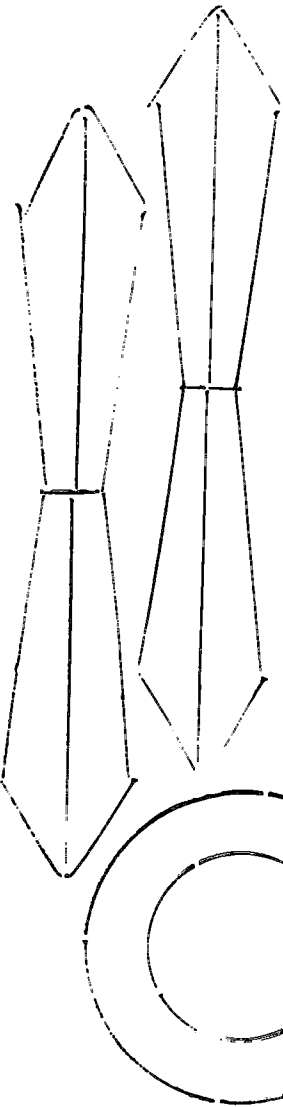
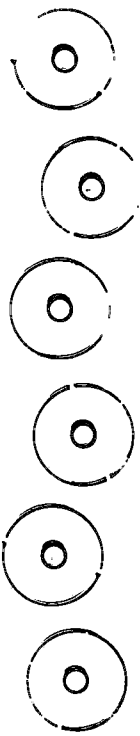
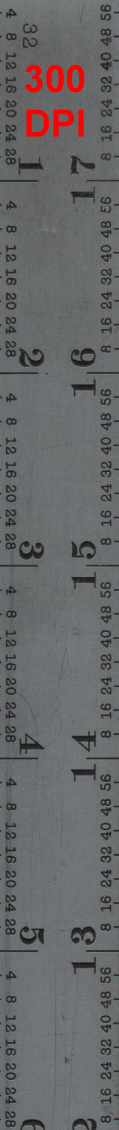

300
DPI

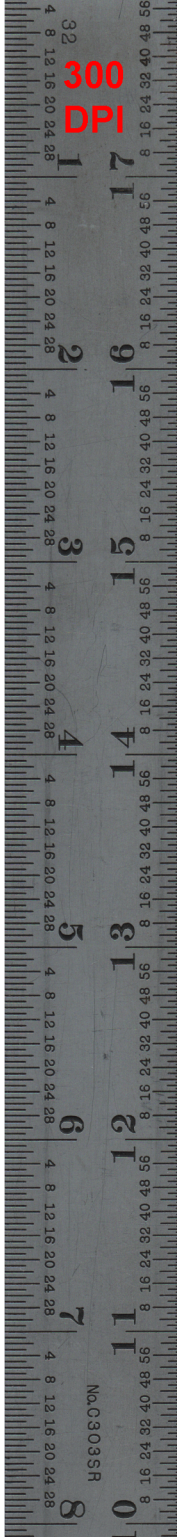

MARS SNOOPER
SP-20 PN 82902

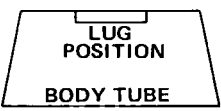
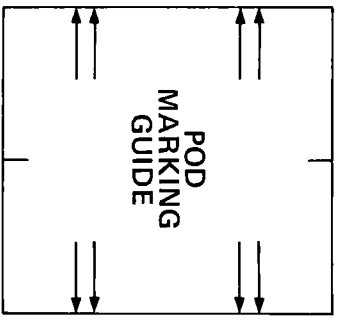
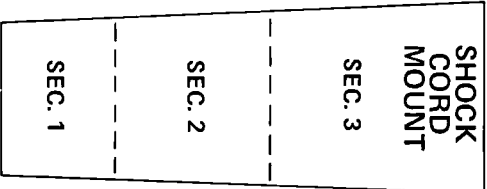
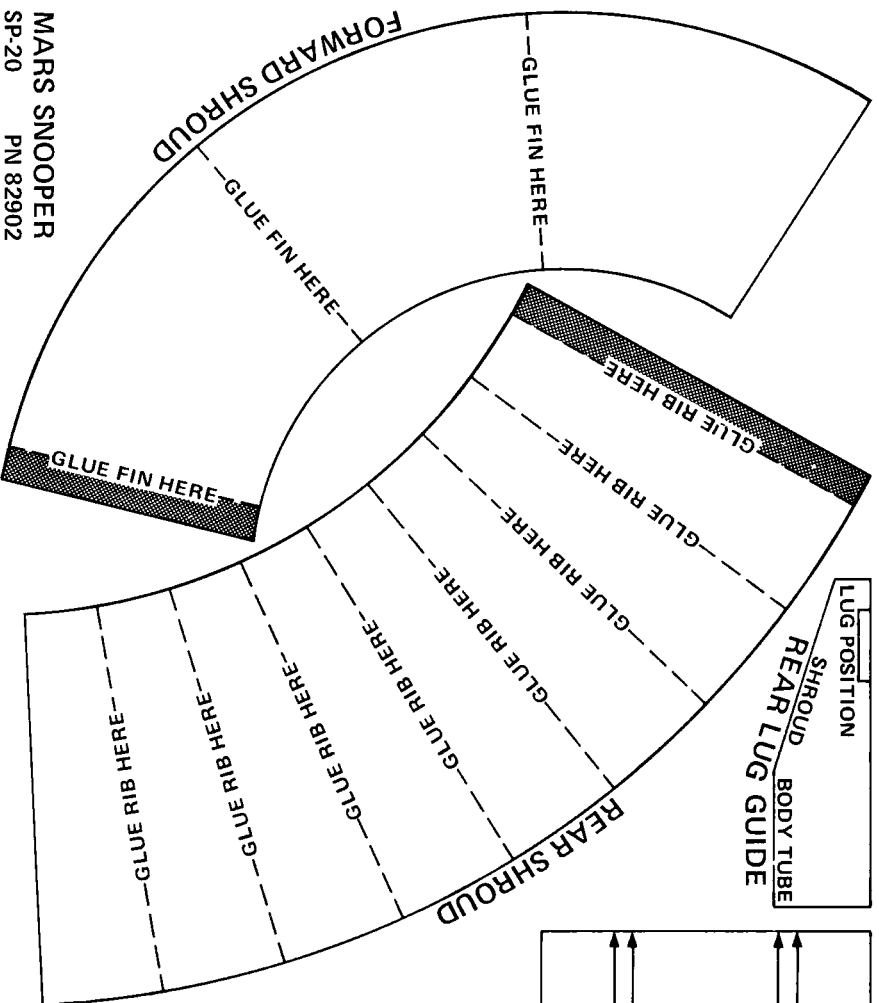

FORWARD LUG GUIDE

No.0303SR

3/32"

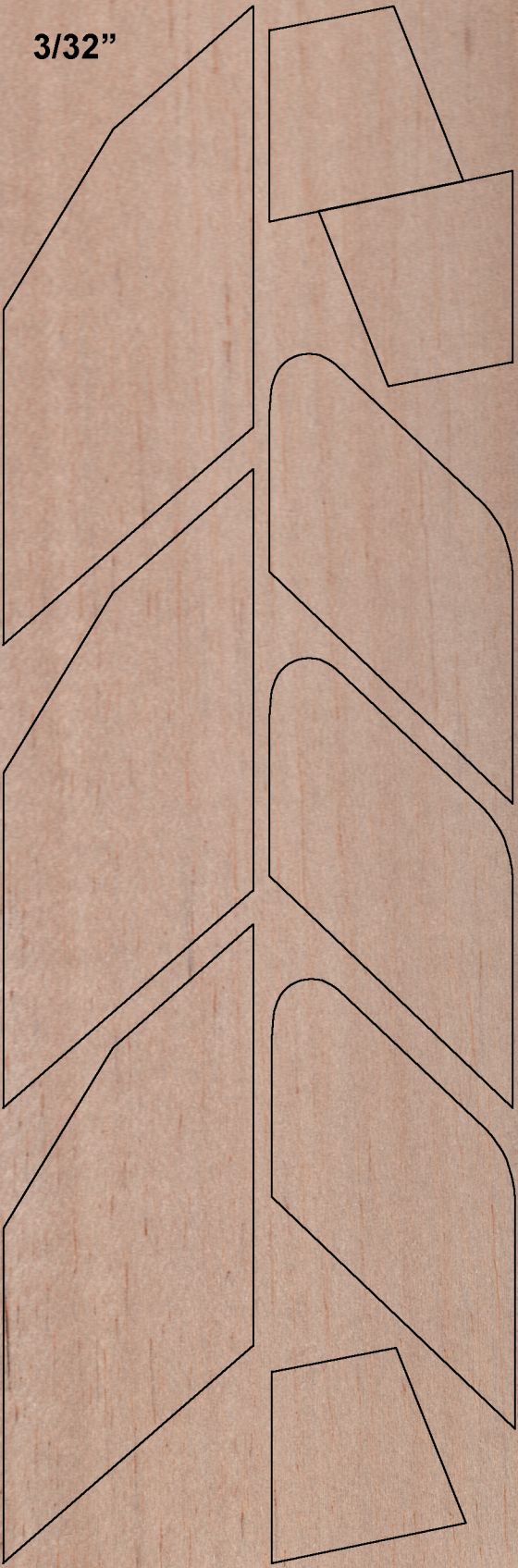

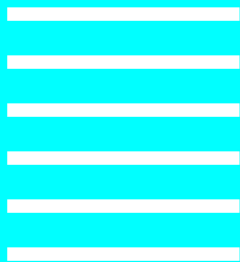

MARS SNOOPER

RADIOUS VIEW

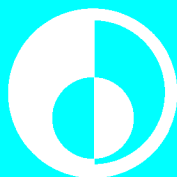
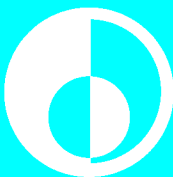
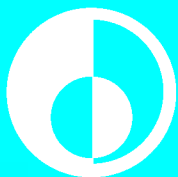
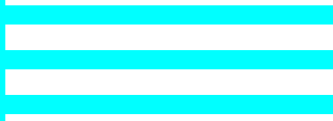
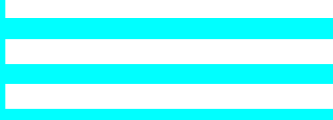

PN 37029 ESTES INDUSTRIES

PARTS LIST KIT NO. 1220 - Mars Snooper II

Quantity	Description	Type	Number	Details1	Details2	Details3	Details4	Comment
1	PAPER BODY TUBE	BT-20J	30326	2.75" long	0.710" ID	0.736" OD	0.013" wall	Glassine
1	ENGINE HOLDER	EH-2	35025	2.8" long	.100" wide	.025" thick		Reg. & D
1	Pattern Sheet	SP-20	82902	4.9" wide	8" long	67 lb. card		Scan
1	SPLIT ADAPTER RING	AR-2050S	80425	1/4" long	.737" ID	.949" OD	0.106" wall	Green
1	ADAPTER RING	AR-2050	30164	1/4" long	.737" ID	.949" OD	0.106" wall	Green
1	Shock Cord	SC-3	85744	1/8" wide	36" long			Rubber
1	PAPER BODY TUBE	BT-50W	30372	9.5" long	0.950" ID	0.976" OD	0.013" wall	Glassine
1	Die-Cut Card Sheet	TA-20	30054	2.5" wide	6" long	0.05" thick	fibercard	Scan
1	BALSA FIN STOCK	*BFS-30	3168	3" wide	9" long	3/32" thick	0.09375	Scan
3	PAPER BODY TUBE	*BT-5J	30304	2" long	0.515" ID	0.541" OD	0.013" wall	Glassine
1	BALSA NOSE CONE	BNC-20N	70236	2.75" long	.736" dia.	.5" shoulder		
1	NOSE CONE WEIGHT	NCW-1	38280	11/16" dia. with center hole	0.12 oz.			Lead Disc
1	PAPER BODY TUBE	BT-20D	30322	6.5" long	0.710" ID	0.736" OD	0.013" wall	Glassine
1	BALSA ADAPTER	TA-2050	70006	3.0" long	2.0" taper	.5" front	.5" back	BT-20 to BT-50
1	Parachute	PK-18A	85566	18" dia.	18" x 6 Shrouds		Org/Wht	
1	Shroud Line	SLT-108	38239	108"	.020" diameter	Twisted cotton		
6	Tape Disc	TD-3F	38406	1/2" dia.	Paper	Self-Stick		Set of 6
1	Screw Eye (Small)	SE-2A	38252	3/4" long				
5	LAUNCH LUG	LL-2AM	38176	5/32" ID	1/8" rod	3/8" long		Mylar
3	WOOD DOWEL	WD-1DE	85903	1/8" dia.	4.5" long			Wood
3	BALSA NOSE CONE	BNC-5BA	70210	.625" long	.541" dia.	.25" shoulder		
1	Decal Sheet	KD-20	37029	4" wide	6.5" long	White	Waterslide	Scan

*Error in parts list, BT-5BJ should be BT-5J. #30304 is 2" long and correct. BT-5BJ is 5.1" long.

*Die-Cut Balsa Fin Sheet type BF-20 #32205. (Not to be confused with BFS-20). Fins are 3/32" not 1/16".



ESTES
 Model Rockets
 Fly the Best Rocket

Richie
MARS SNOOPER II



- REAL SPACE-APPEARANCE
- TUNING DISCS
- ADVANCED STRUTS
- CORRUGATED TOUCH-DOWN PADE

SKILL LEVEL

- 1-Beginner 2-Intermediate 3-Experienced 4-Advanced 5-Expert

SPECIFICATIONS

Length 22.2" (56.9 cm) Weight 1.5 oz. (42.7 g)
 Body Dia. 5.315" (135.4 mm) 18" Powerline Factory

RECOMMENDED ENGINES

A6-3 B6-2 B6-4 C6-5

Use A6-3 for first flights.

Engines and launcher not included.

#1220

ESTES INDUSTRIES
 MINNETONKA, MINN.

FLY ESTES
Model Rockets
 A Hobby Made for Ages 10 to Adult

ESTES INDUSTRIES, INC.
 18000 Highway 101
 Minnetonka, MN 55345
 Phone: (612) 895-9300
 Fax: (612) 895-9301
 Website: www.estes.com



WANTED STORES

Astrom MARS SNOOPER II



- REAL SPACESHIP APPEARANCE
- FUTURISTIC DECOR
- ADVANCED STYLING
- SIMULATED TOUCH DOWN PADS

SKILL LEVEL 4

1-Beginner 2-Intermediate 3-Craftsman 4-Advanced 5-Expert

SPECIFICATIONS

Length 22.3" (56.8 cm)

Weight 2.2 oz. (62 g)

Body Dia. 0.876" (24.8 mm)

16" Parachute Recovery

RECOMMENDED ENGINES

A8-3 B4-2 B6-4 C6-5

Use A8-3 for first flight.

Engine and launcher not included.

#1220

ENTER INDUSTRIES

PO BOX 10000, GAITHERSBURG, MD 20878