



# Vindicator

SKILL LEVEL 3 - Recommended for Craftsman Rocketeers.

**RECOMMENDED ENGINES:**

B4-2 B6-2 B6-4 (1st Flt.) B8-5 C6-3 C6-5

## BEFORE YOU START

Read all instructions before beginning construction on your model. Make sure you have all parts and materials. When you are thoroughly familiar with the assembly procedure, begin construction. Check off each step as you complete it. In each step, test-fit the parts together before applying any glue. If some part doesn't fit properly, sand lightly or build up as required for precision assembly.

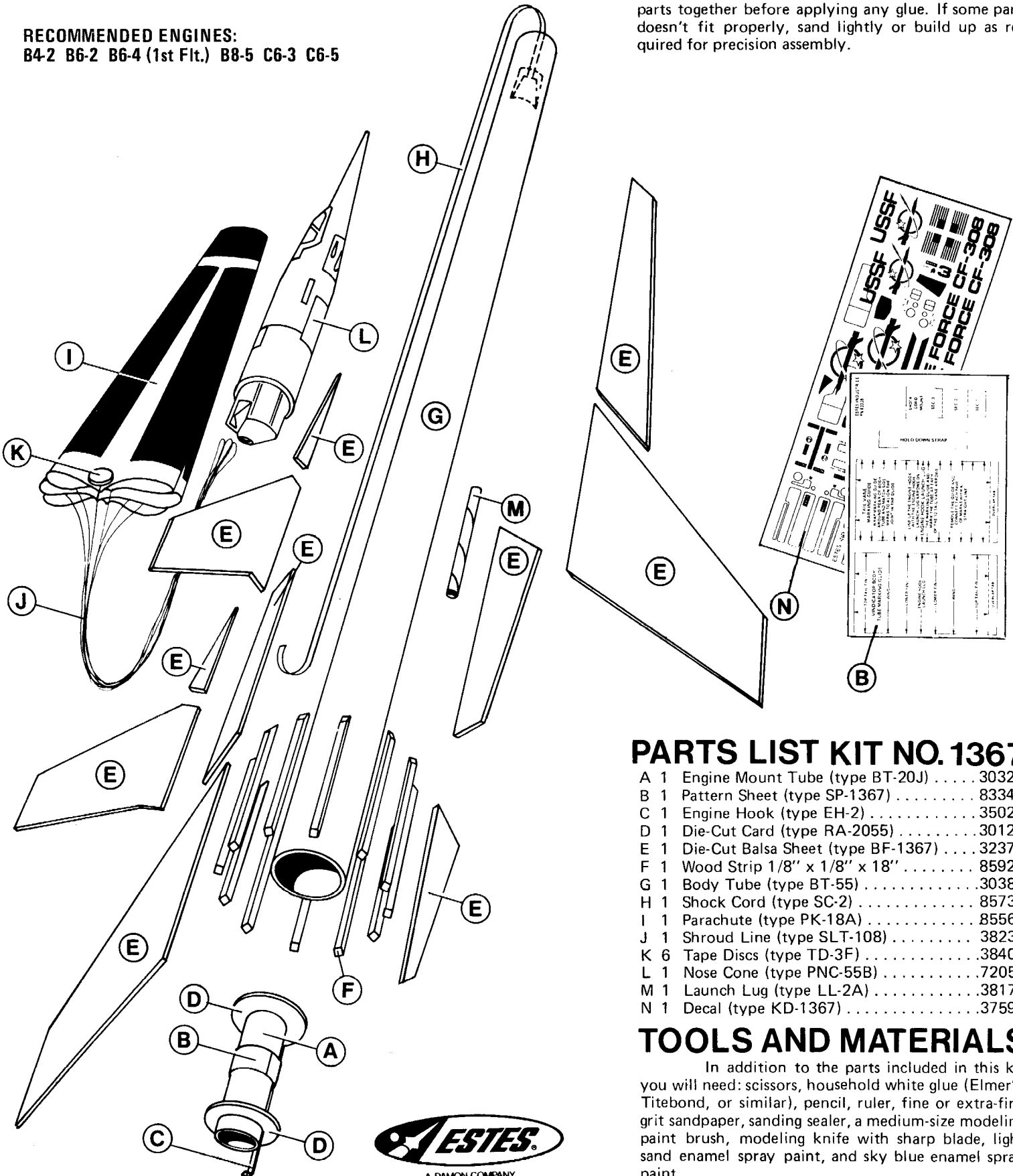

## PARTS LIST KIT NO. 1367

A	1	Engine Mount Tube (type BT-20J)	30326
B	1	Pattern Sheet (type SP-1367)	83348
C	1	Engine Hook (type EH-2)	35025
D	1	Die-Cut Card (type RA-2055)	30126
E	1	Die-Cut Balsa Sheet (type BF-1367)	32373
F	1	Wood Strip 1/8" x 1/8" x 18"	85921
G	1	Body Tube (type BT-55)	30382
H	1	Shock Cord (type SC-2)	85736
I	1	Parachute (type PK-18A)	85566
J	1	Shroud Line (type SLT-108)	38239
K	6	Tape Discs (type TD-3F)	38406
L	1	Nose Cone (type PNC-55B)	72056
M	1	Launch Lug (type LL-2A)	38175
N	1	Decal (type KD-1367)	37594

## TOOLS AND MATERIALS

In addition to the parts included in this kit you will need: scissors, household white glue (Elmer's, Titebond, or similar), pencil, ruler, fine or extra-fine grit sandpaper, sanding sealer, a medium-size modeling paint brush, modeling knife with sharp blade, light sand enamel spray paint, and sky blue enamel spray paint.



# ASSEMBLY INSTRUCTIONS

1

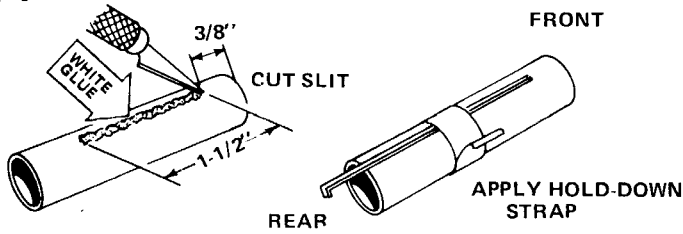

Cut a 1/8" wide slit in the engine mount tube (part A), 3/8" from one end as shown. Cut out the hold-down strap from the pattern sheet (part B). Apply a 1-1/2" long line of glue to the tube as shown. Push one end of the engine hook (part C) into the slit and press the main part of the hook into the glue. Apply glue to one side of the hold-down strap, and wrap it tightly around the middle of the tube over the engine hook.

2

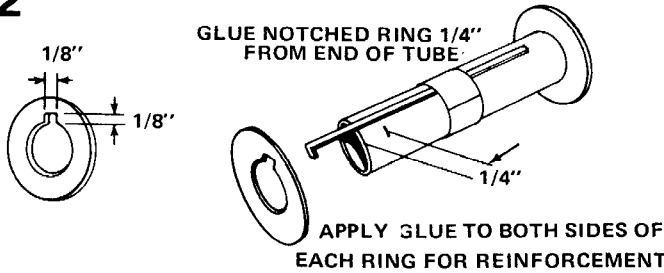

Separate the adapter rings from the die-cut card (part D). Cut a notch in one of the rings as illustrated and glue the rings to the engine mount tube. The notched ring should be placed over the engine hook. Let this assembly dry completely.

3

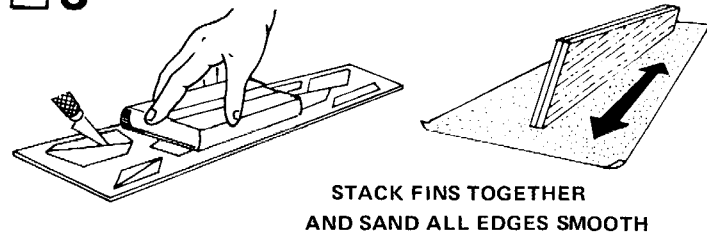

Fine-sand the balsa die-cut sheet (part E), then carefully remove the die-cut parts from the sheet by freeing the part edges with a sharp knife. Sand the edges of the fin parts slightly to remove any rough spots, but leave edges square and sharp.

4

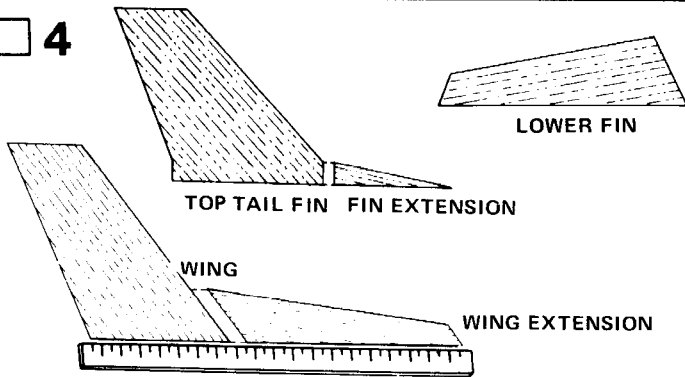

Sort and identify parts as shown. Glue extensions to the top tail fins and to both wings. Apply glue to both edges to be joined. Let glue partially dry. Apply a second bead of glue to one edge and press parts together. Set bottom edge of parts against a ruler to make sure they are straight. Wipe away excess glue and set fins and wings aside to dry.

5

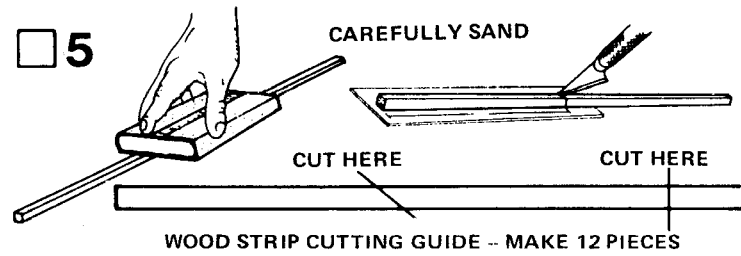

Fine-sand all the sides of the 1/8" square wood strip (part F) until smooth. Using the drawing shown above, lay the wood strip on the drawing and cut to length shown. Make 12 identical pieces.

6



Apply a coat of sanding sealer to each fin. Apply sealer to all edges except the root edge. When sealer is dry, lightly sand all the sealed surfaces. Repeat sealing and sanding process until balsa grain no longer shows.

7

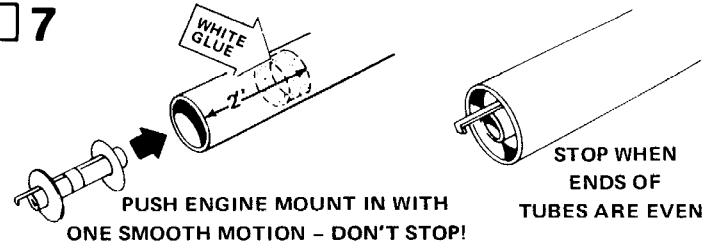

Smear glue around the inside of the rear end of the rocket body tube (part G) to cover an area about 2" from the end of the tube. Use a stick or dowel as shown. Immediately insert the engine mount being careful to position it so the end of the tubes are even and the hook projects out of the end of the body tube. Push engine mount in with one smooth motion.

8

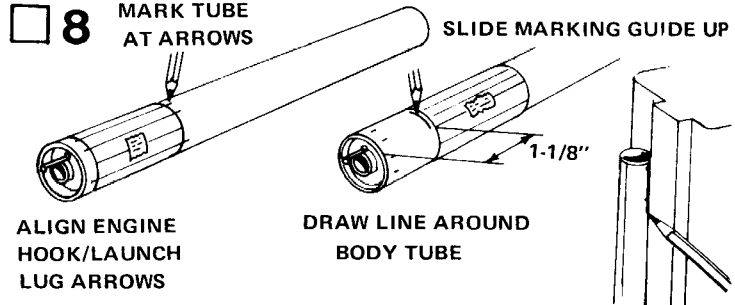

Cut out the tail vane marking guide from the pattern sheet and wrap it around the body tube close to the rear of the body tube. Align the engine hook/launch lug arrows on the marking guide with the engine hook of the engine mount. Mark the body tube at each arrow point. Slide the marking guide up the tube to 1-1/8" from the end of the tube as shown. Draw a line around the tube at this point using the edge of the marking guide as a straight edge. Draw straight lines connecting each mark. A door frame inside edge can be used as a guide as shown. Extend the lines about 2" up from the rear of the tube.

9

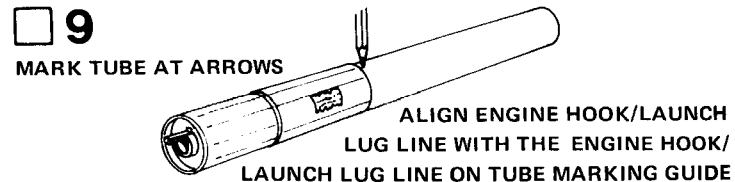

Cut out the tube marking guide from the pattern sheet and wrap it around the body tube up from the line drawn around the body tube in the previous step. Align the engine hook/launch lug line

with the engine hook/launch lug line on the tube marking guide. Mark the body tube at each arrow point. Draw straight lines connecting each mark. Extend the lines about 10" from the rear of the tube.

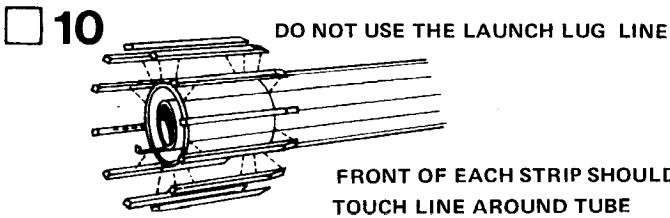

Glue the 12 wood strips, centered on their alignment lines, to the body tube as shown. Make sure you DO NOT use the launch lug line for a wood strip alignment line. The front of each strip should touch the line drawn around the body tube.

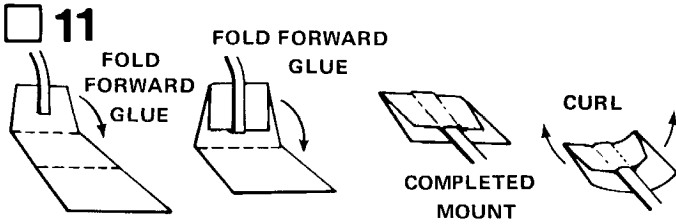

Cut out the shock cord mount from the pattern sheet. Crease it on the dotted lines by folding. Spread glue on the first section (1) and lay the end of the shock cord (part H) into the glue. Fold over and apply glue to the back of the first section and the exposed part of section 2. Lay the shock cord as shown and fold over again. Clamp the unit together with your fingers until the glue sets.

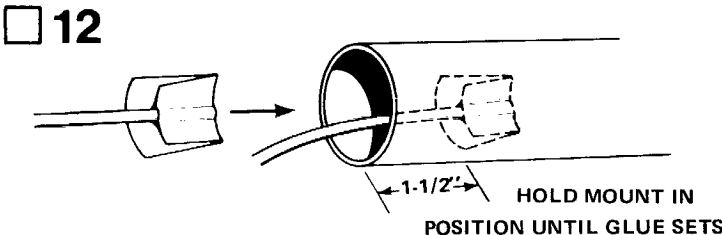

Smear glue over the entire back side of the shock cord mount. Hold the mount as shown and press it into place inside front end of the rocket body tube. Make sure the front of the mount is at least 1-1/2" from the end of the tube. Hold the mount in place until the glue sets.

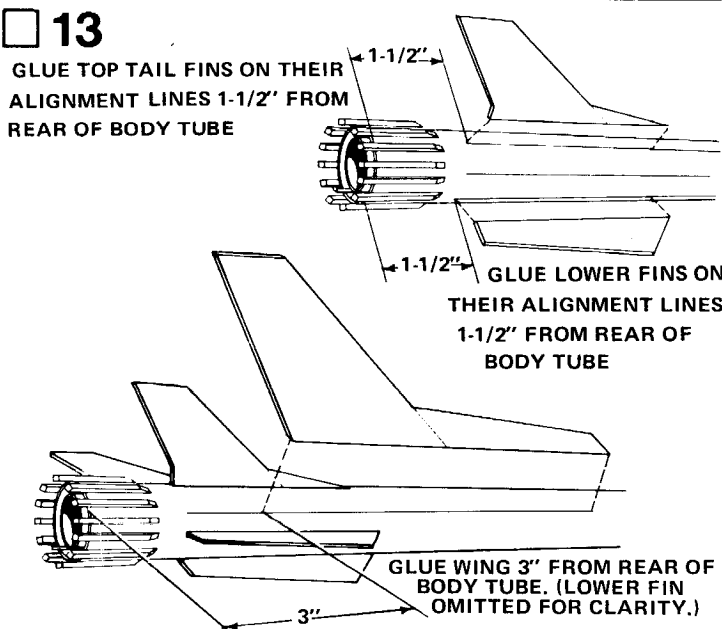

Rub a line of glue into the root edge of each fin and allow to dry. Apply glue to the fins and position fins on the alignment lines in

their correct positions on the tube. Refer to the illustration to be sure of these positions. Adjust the fins so they project straight away from the body tube. Do not set the rocket on its fins while the glue is wet.

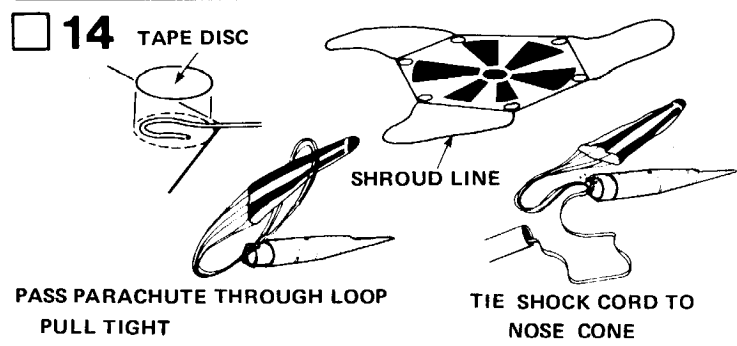

Cut out the parachute (part I) on its edge lines. Cut three 36" lengths of shroud line (part J). Attach the line ends to the top of the parachute with tape discs (part K) as shown. Pass the shroud line loops through the ring on the nose cone (part L). Pass the parachute through the loop ends and draw the lines tight against the ring. Set the knot with a drop of glue. Tie the free end of the shock cord to the nose cone.

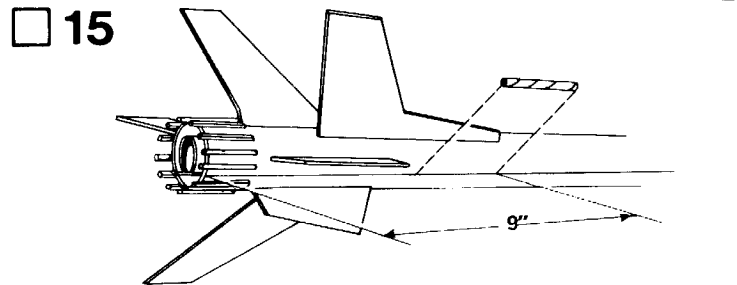

Glue the launch lug (part M) to rocket body tube on the launch lug line. The front of the lug should be 9" from the rear of the rocket body tube. Align the launch lug straight along the body.

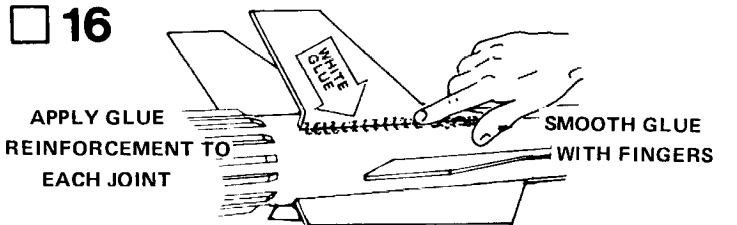

When the glue on the fin joints has dried, apply a glue reinforcement to each fin/body tube joint. Holding the model level, apply a line of glue to both sides of each fin joint. Smooth out the glue with your finger. IMPORTANT -- Keep the model level until the glue dries.

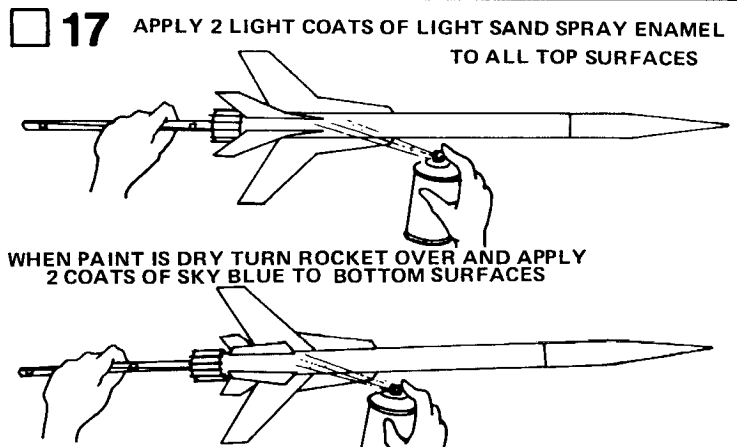

When all glue on outside of the rocket body is dry, insert a sheet of rolled-up newspaper or heavy paper into the rear of the rocket as

shown. Holding the rocket horizontally with the top tail fins and canopy detail on nose cone pointing straight up, apply two light coats of light sand spray enamel paint to all the top surfaces of the wings, fuselage, nose cone, and the sides of the top tail fins. When paint is dry, turn rocket over and apply at least two coats of sky blue spray enamel paint to only the bottom surfaces of the rocket. Along the sides of the rocket there should occur a blending of the two paints. Allow paint to dry thoroughly. Follow instructions on paint cans for best results.

**18**

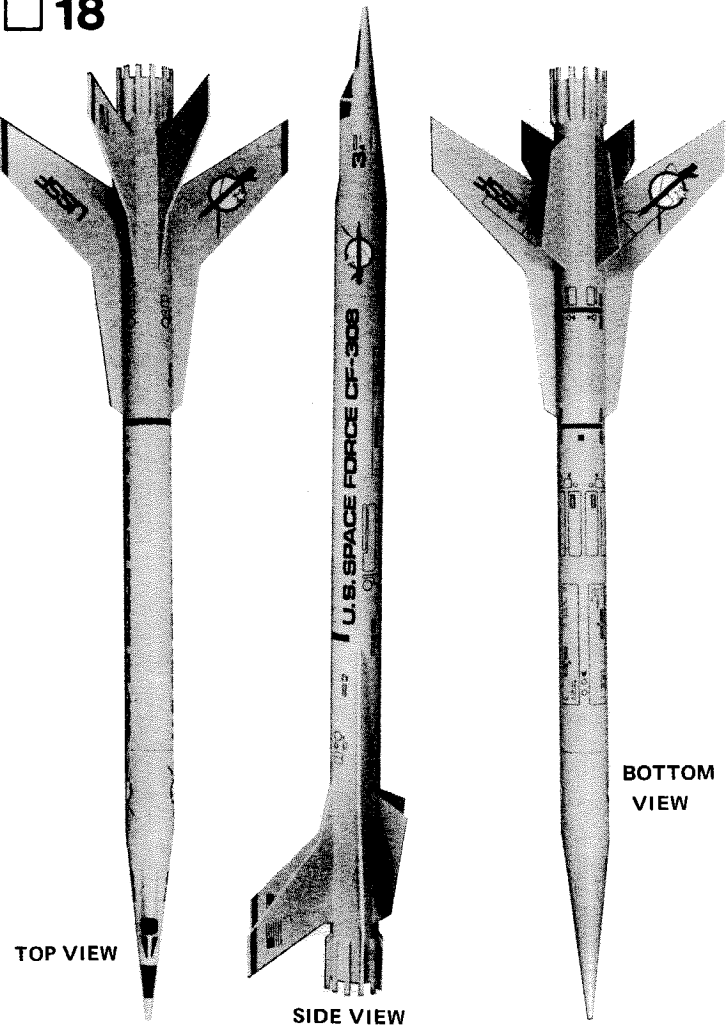

Apply the decals (part N) in the positions shown. Cut out a decal section, dip in lukewarm water for 10-20 seconds, and hold it until it starts to uncurl. Slip the decal off the backing sheet and onto the model. Blot excess water away. For best results, let model dry overnight and apply a coat of clear spray to protect the decals.

**LAUNCHING COMPONENTS**

- To launch your rocket you will need the following items:
- An Estes model rocket launch system
- Parachute recovery wadding (Estes Cat. No. 2274)
- Recommended engines: B4-2, B6-2, B6-4, B8-5, C6-3, and C6-5. Use a B6-4 engine for your first flight.

Be sure to follow the HIAA-NAR\* Model Rocket Safety Code when carrying out your model rocket activities.

\*HIAA -- Hobby Industry Association of America  
 NAR -- National Association of Rocketry

**COUNTDOWN CHECKLIST**

**T-13**

Pack 5 or 6 squares of loosely crumpled recovery wadding into the rocket body tube.

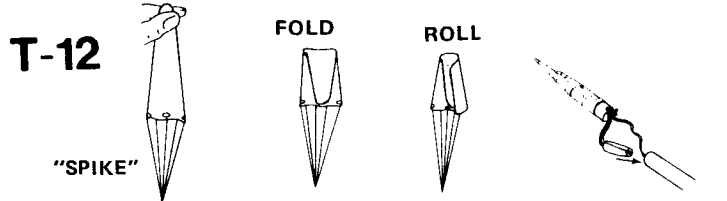

form a "spike" shape. Fold this spike in half. Roll parachute into tube shape to fit easily into body. Pack 'chute into the tube on top of the wadding. Pack the shroud lines and shock cord in on top of the parachute and slip the nose cone into place.

**NOTE:** DO NOT pack parachute until you are actually ready to launch. For maximum parachute reliability, lightly dust the 'chute with ordinary talcum powder before each flight, especially in cold weather.

**NOTE:** Nose cone should separate easily from rocket body tube, but should not be extremely loose. If fit is too tight, sand inside of body tube and shoulder of nose cone with fine sandpaper. If fit is too loose, add a wrapping of transparent tape or masking tape to the shoulder of the nose cone.

**T-11**

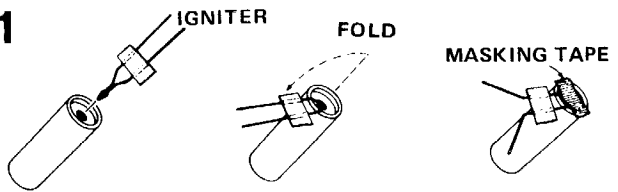

Select an engine and install an igniter as directed in the engine instructions. Use a B6-4 engine for your first flight.

**T-10**

Insert engine into rocket engine mount. Engine hook must latch securely over end of the engine.

**T-9**

Disarm the launch panel -- REMOVE SAFETY KEY!

**T-8**

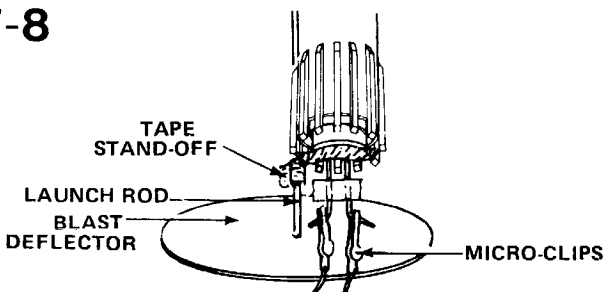

Slide launch rod through rocket launch lug and place rocket on launch pad. Make sure the rocket slides freely on the launch rod. Clean the micro-clips and attach them to the igniter wires. Arrange the clips so they do not touch each other or the metal blast deflector. Attach clips as close to engine as possible.

**T-7**

Clear the launch area, alert recovery crew and trackers. Check for low flying aircraft and unauthorized persons in the recovery area.

**T-6**

Arm the launch panel -- INSERT SAFETY KEY!

**-5-4-3-2-1-LAUNCH!!**

Repeat Countdown Checklist for each flight.

**MISFIRE PROCEDURE**

Occasionally the igniter will heat and burn into two pieces without igniting the engine. This is almost always caused by a failure to install it correctly. REMOVE SAFETY KEY from launch panel, remove the model, clean the igniter residue from the engine nozzle, and install a new igniter. Repeat the Countdown Checklist.

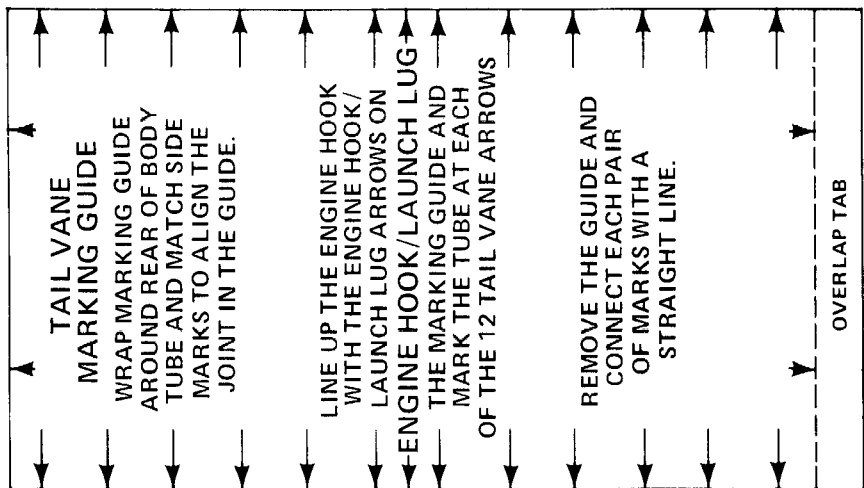
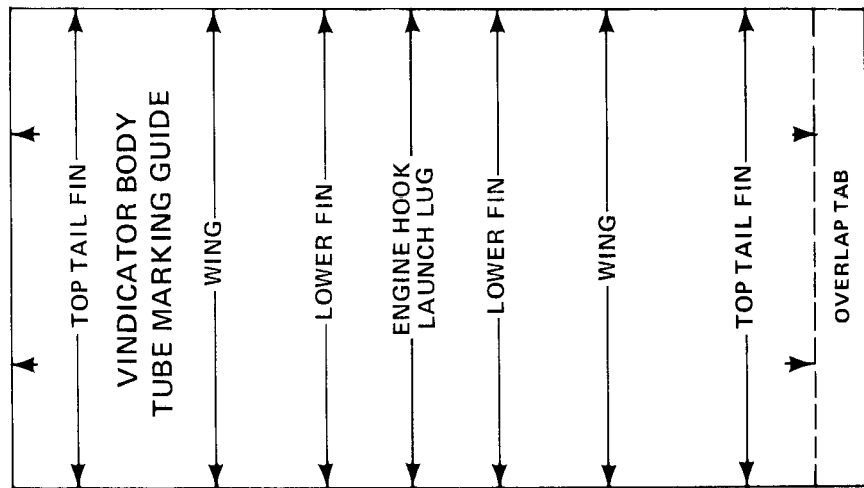

HOLD-DOWN STRAP

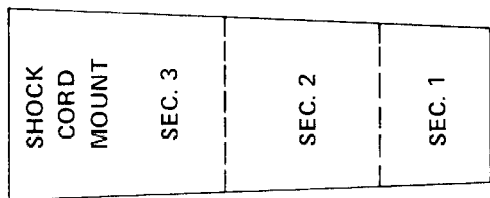

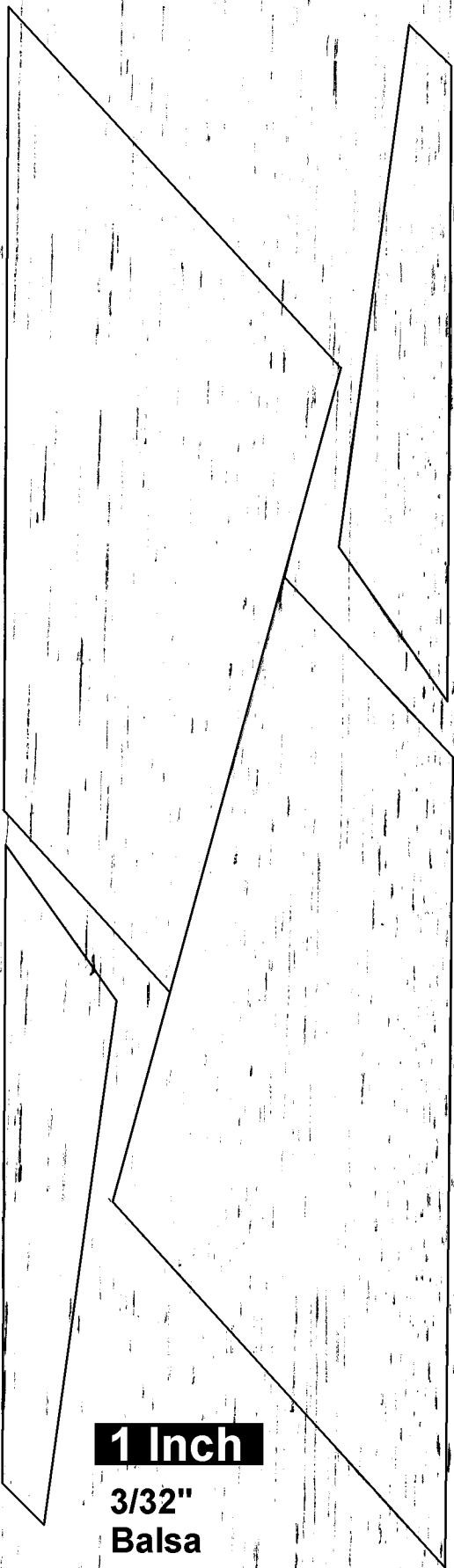

**1 Inch**

**3/32"  
Balsa**

**1 Inch**

**3/32"  
Balsa**

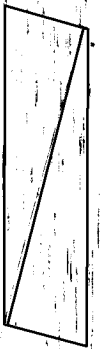
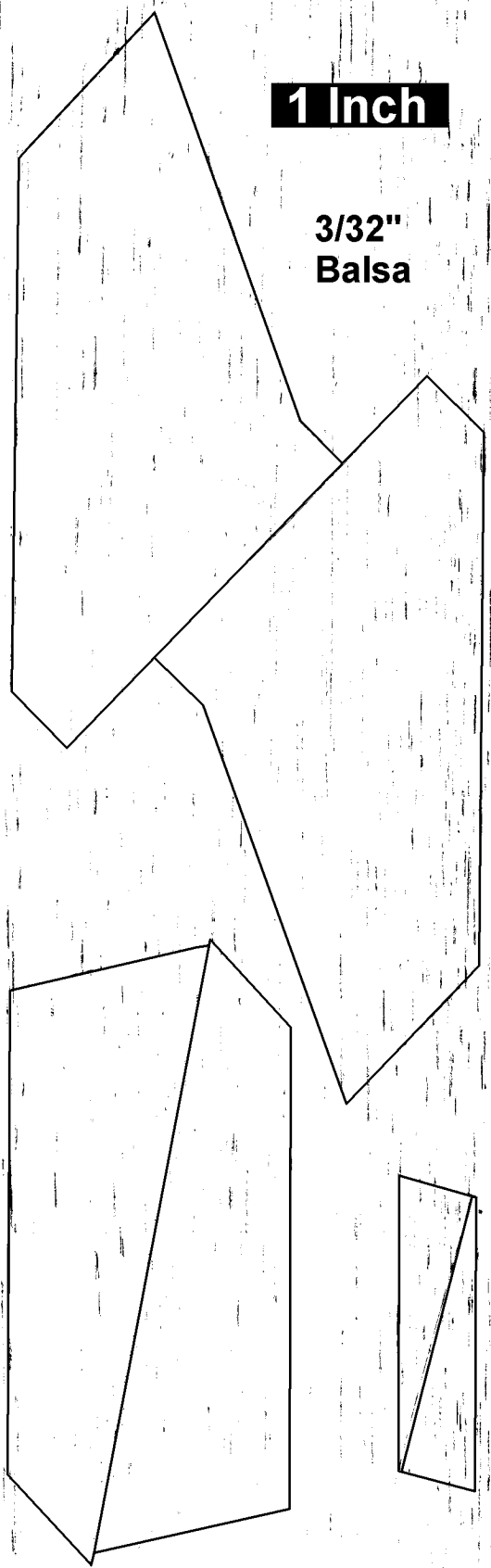

USSF

USSF

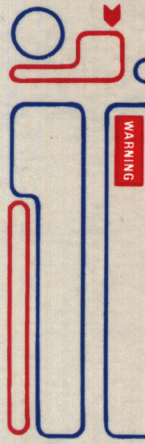

U.S. SPACE FORCE CF-308  
U.S. SPACE FORCE CF-308

ESTES IND PN37594

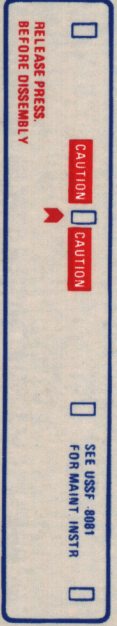



# Vindicator

## FLYING MODEL ROCKET

**SKILL LEVEL 3**  
Intermediate Beginner  
10-12 years of age

- Missile Interceptor
- Polyurethane Landing Gear
- Detailed Engine Section
- Ready-to-Fly Display Model
- No Cut Lines
- Quick Release Engine Mount
- Big "W" Parachute Recovery
- Missile Kit Details

**FREE**  
with purchase of  
any 2008  
kit

Launch the Vindicator  
the 10th anniversary  
of the space shuttle  
Program and the  
20th anniversary  
of the STS-51-L

For more information on  
the Vindicator, visit us at  
[www.horizonhobby.com](http://www.horizonhobby.com)

