





photon probe™

FLYING MODEL ROCKET #2043

ESTES INDUSTRIES
1295 H Street
Penrose, CO 81240 USA

PARTS AND SUPPLIES

Locate the parts shown and lay them out on the table in front of you.

ASSEMBLY TIP

Read all instructions before beginning work on your model. Make sure you have all parts and supplies. Test-fit all parts together before applying any glue. If any parts don't fit properly, sand as required for precision assembly.

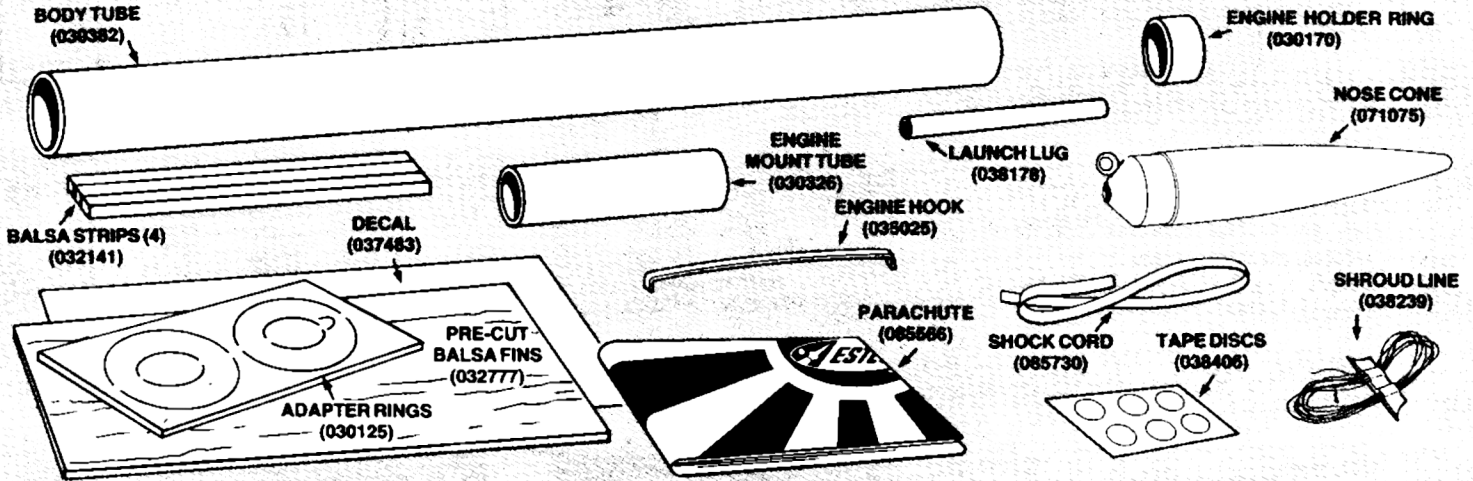

In addition to the parts included in this kit, you will need the following:

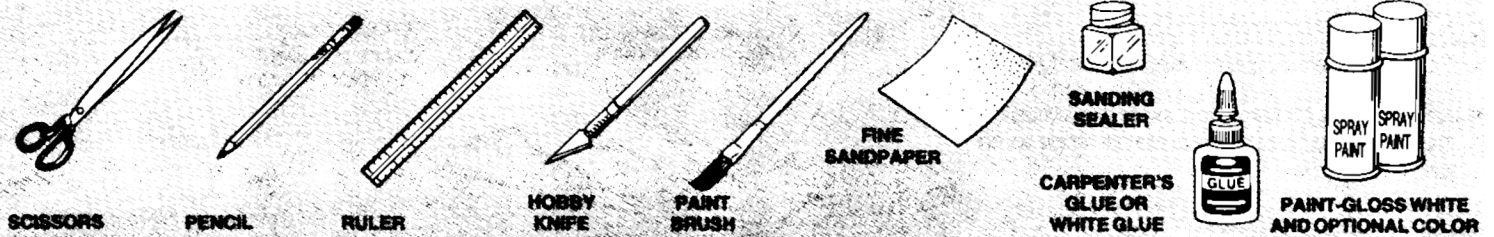

ROCKET ASSEMBLY

1.

- Mark engine mount tube 1" (25 mm) and 2 1/2" (64 mm) from one end. Cut an 1/8" (3 mm) wide slit at the 2 1/2" (64 mm) mark.
- Apply glue around tube just in front of 1" (25 mm) mark. Push one end of engine hook into slit and lay straight on tube. Slide engine holder ring over hook and down to 1" (25 mm) mark.
- Glue notched adapter ring against holder ring as shown.
- Glue unnotched adapter ring against forward end of engine hook.

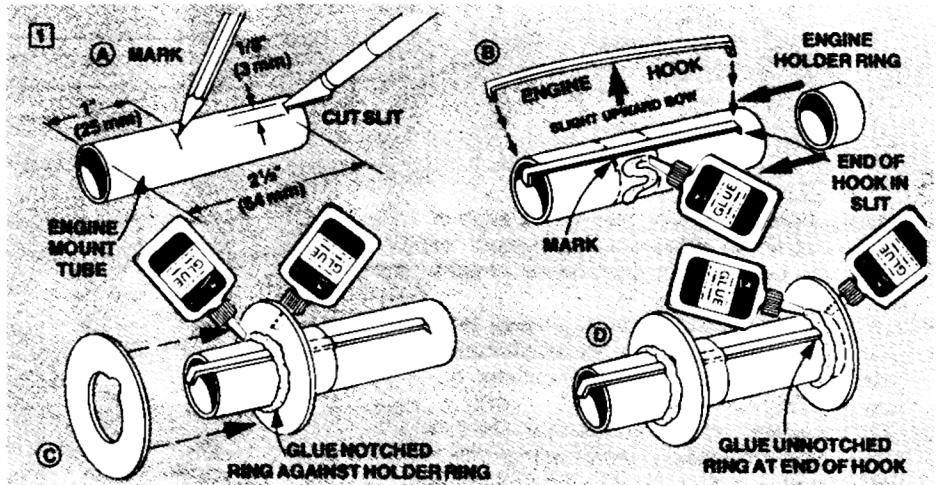

2.

- Check fit of completed engine mount in body tube. Sand adapter ring edges if necessary.
- Apply glue around inside of one end of body tube. Glue should be about 3/4" (19 mm) from end of tube.
- Push engine mount into body tube until tube ends are even.
- Add glue reinforcement around rear ring and body tube joint as shown.

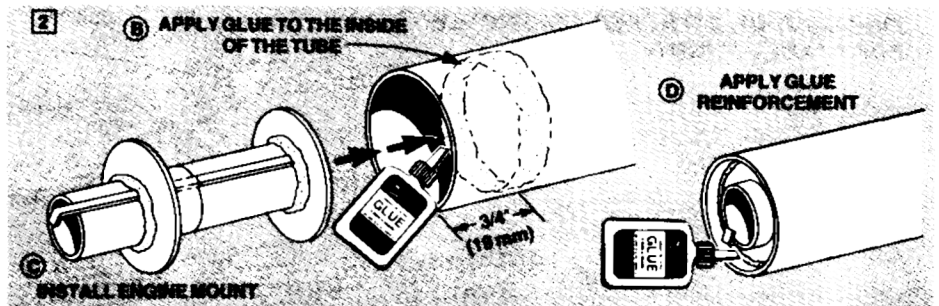

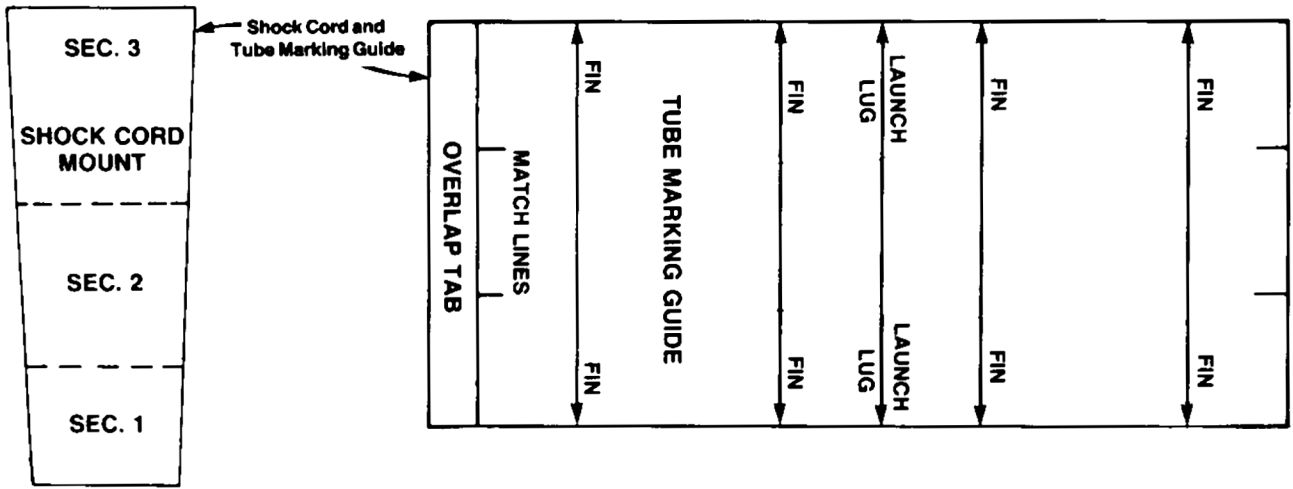

3.

- Cut out tube marking guide above.
- Wrap guide around the tube and tape. Mark tube at arrows. Remove guide.
- Draw straight lines connecting each pair of marks. Extend all lines 7" (178 mm).

3

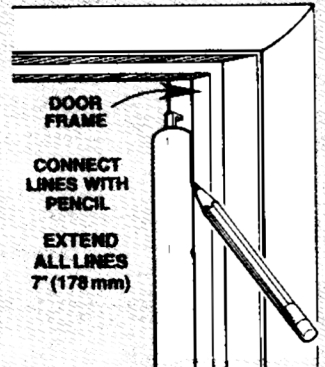
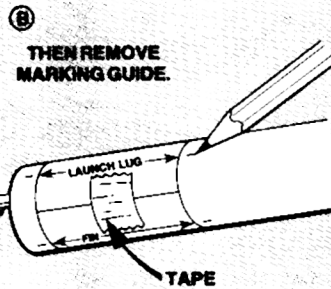

4.

- Fine sand balsa die-cut sheets. Carefully remove fins by freeing edges with sharp knife.
- Stack fins together. Sand all edges smooth.
- Sand both ends of the four balsa strips to an angle as shown.

4

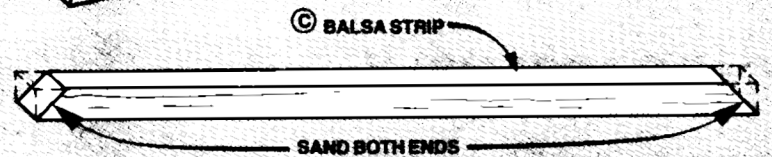
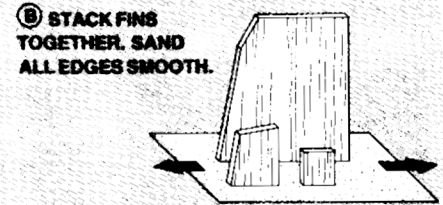

5.

- Apply a small amount of glue to root edge of a fin. Glue fin on alignment line. Repeat for other fins. Let each fin dry several minutes before applying the next fin.
- Apply glue to the root edge of a balsa strip. Glue strip on alignment line. Repeat for other strips. Let each strip dry several minutes before applying the next one.
- Looking at the rocket from the rear, the fins should be in the positions shown with the trailing edge of each fin even with the end of the tube.
FINS MUST BE ATTACHED CORRECTLY FOR STABLE FLIGHT!

5

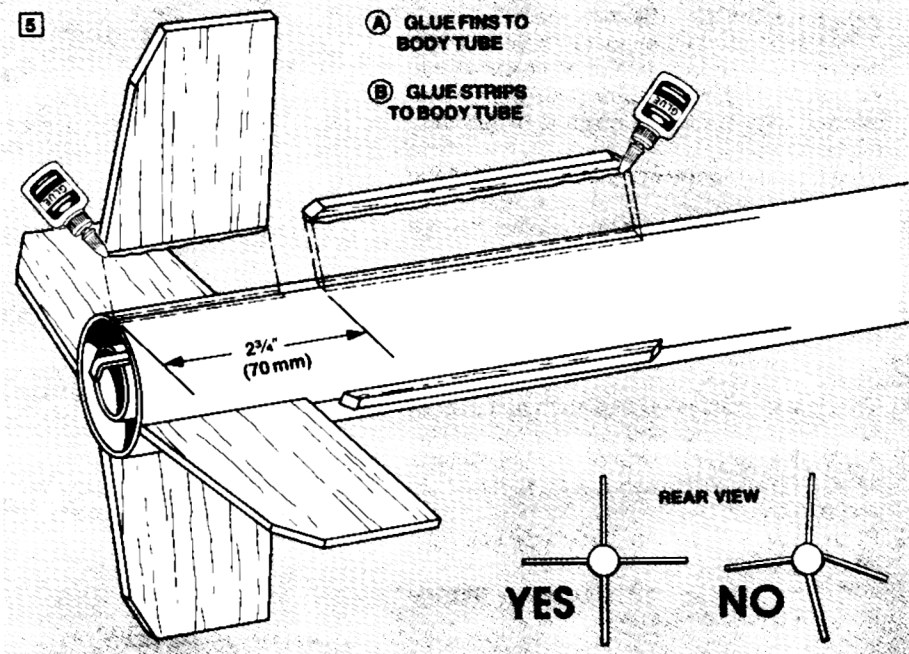

6.

- Rub glue into the root edge of each dorsal fin and allow to dry.
- One fin at a time, add more glue and attach to balsa strips as shown. Be sure fins are centered on strip before glue dries.

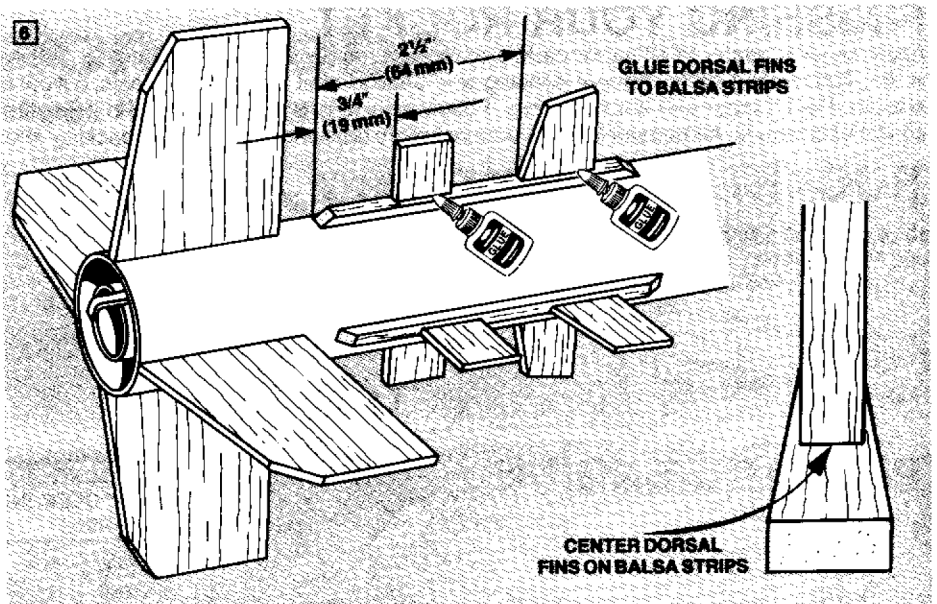

7.

- Glue launch lug on launch lug line 4" (102 mm) from end of body tube as shown. Launch lug must be straight on body tube.
- Apply a bead of glue as reinforcement to each side of each fin/body tube joint and to each side of the launch lug. Smooth them out with your finger. Support the rocket horizontally until glue dries.

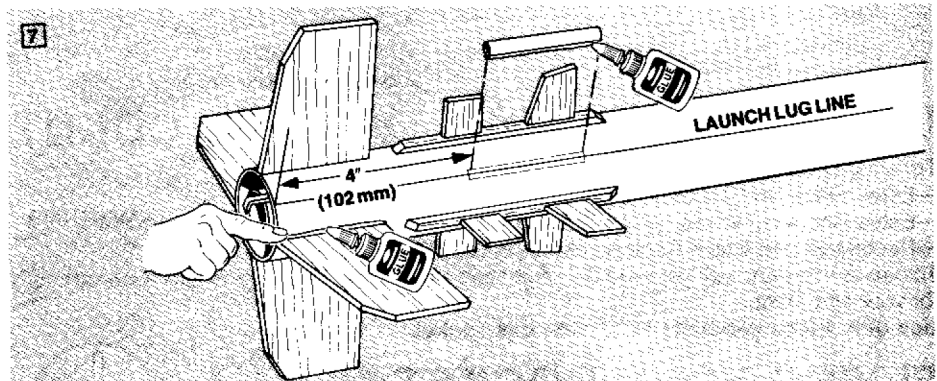

8.

- Cut shock cord mount from page 2.
- Crease on dotted lines by folding. Spread glue on section 2 and lay end of shock cord into glue at a slight diagonal as shown. Fold section 1 forward. Apply glue to section 3. Fold forward again. Clamp firmly with your fingers until glue sets.
- Apply glue to shock cord mount. With the shock cord mount positioned on the end of your finger or a pencil, gently position the mount into the front of the body tube. Set back far enough from the front edge of the tube to allow the nose cone to fit into place (1 1/2" - 38 mm). Press shock cord mount into position. Smear a film of glue over the mount and surrounding area in the body tube to insure a good bond and a smooth surface.

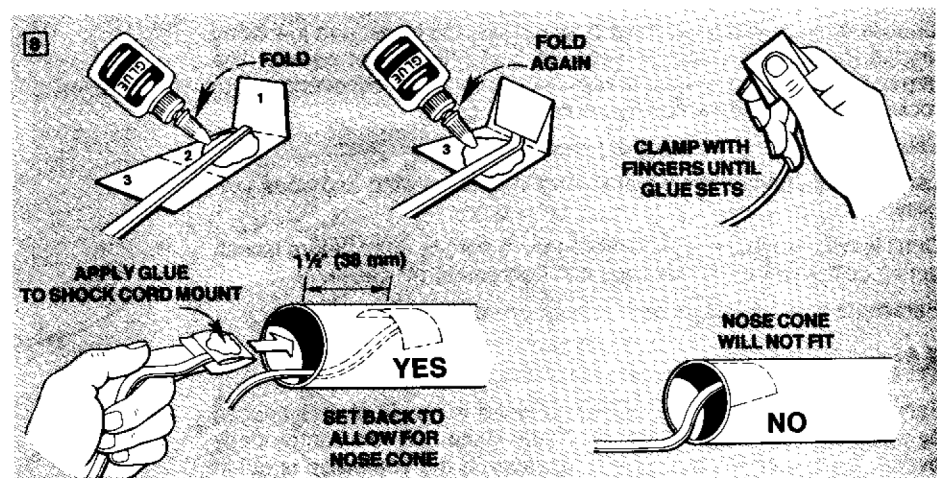

9.

- Cut out parachute on edge lines.
- Cut three 35" (889 mm) lengths of shroud line.
- Form small loops with shroud line ends and press onto sticky sides of tape discs.
- Attach tape discs with the line ends to top of parachute as shown.
- Firmly press tape discs into place until both tape discs and parachute material are molded around shroud line loops.
- Pass shroud line loops through eyelet on nose cone. Pass parachute through loop ends and pull lines against the nose cone.
- Tie the free end of shock cord to nose cone eyelet using a double knot.

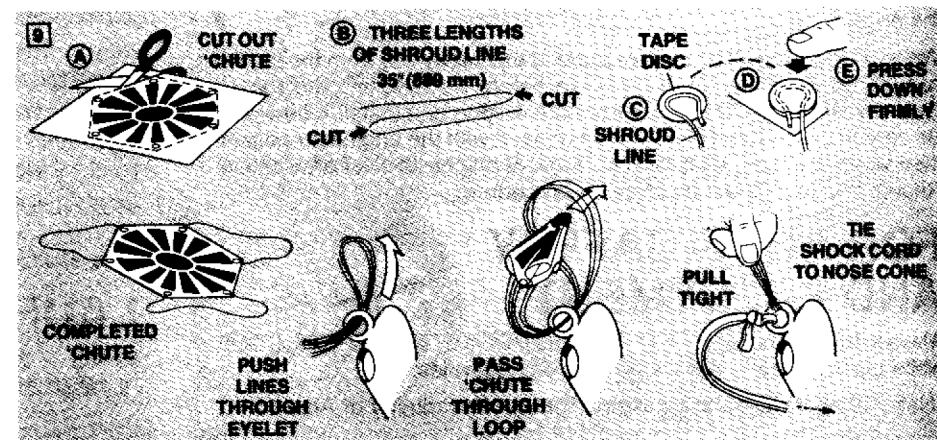

FINISHING YOUR ROCKET

Apply sanding sealer to all paper parts and wood parts. When sealer is dry, lightly sand parts. Repeat sanding and sealing until parts are smooth. Paint model with spray enamel. Follow instructions on spray can for best results. Allow paint to dry overnight before applying decals.

Refer to illustration and photo on panel for decal placement. To apply decals, cut out each decal, trim away clear as close to detail as possible. Dip in lukewarm water for 20 seconds, hold until it uncurls, slip decal off backing sheet onto model and blot excess water.

ROCKET PREFLIGHT

CRUMPLE AND INSERT
4 OR 5 SQUARES OF
RECOVERY WADDING

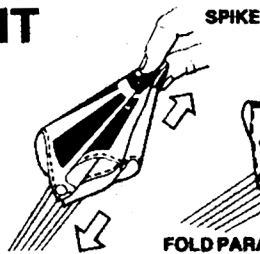
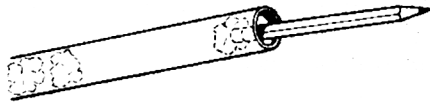

FOLD PARACHUTE



ROLL

WRAP LINES LOOSELY AROUND CHUTE. INSERT PARACHUTE INTO ROCKET.

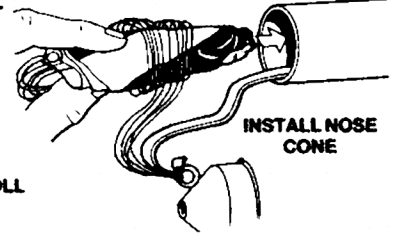

INSTALL NOSE CONE

PREPARE ENGINE

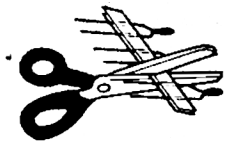

SEPARATE THE IGNITERS

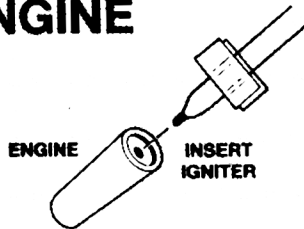

ENGINE

INSERT IGNITER

IGNITER TIP MUST TOUCH PROPELLANT DEEP INSIDE NOZZLE OPENING

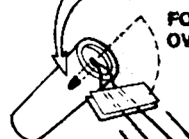

FOLD OVER

BEND LEADS IN U SHAPES

PRESS MASKING TAPE FIRMLY OVER END OF ENGINE

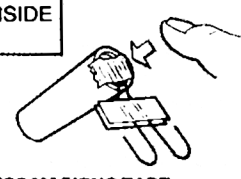

INSTALL ENGINE IN ROCKET

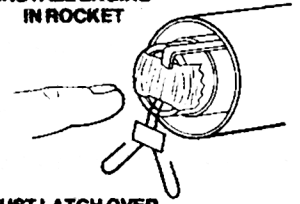

HOOK MUST LATCH OVER END OF ENGINE

LAUNCH SUPPLIES

To launch your rocket you will need the following items:

- Estes Electrical Launch System
 - Estes Recovery Wadding No. 2274
 - Recommended Estes Engines: A8-3, B4-4, B6-4, B8-5 or C6-5.
- To become familiar with your rocket's flight pattern, use an A8-3 engine for your first flight.

Use only Estes products to launch this rocket.

FLYING YOUR ROCKET

Choose a large field away from power lines, tall trees, and low flying aircraft. Try to find a field at least 250 feet (76 meters) square. The larger the launch area, the better your chance of recovering your rocket. Football fields and playgrounds are great.

Launch area must be free of dry weeds and brown grass.

Launch only during calm weather with little or no wind and good visibility.

Don't leave parachute packed more than a minute or so before launch during cold weather [colder than 40° Fahrenheit (4° Celsius)].

Parachute may be dusted with talcum powder to avoid sticking.

MISFIRES

Failure of the model rocket engine to ignite is nearly always caused by incorrect igniter installation. An Estes igniter will function properly even if the coated tip is chipped. However, if the coated tip is not in direct contact with the engine propellant, it will only heat and not ignite the engine.

When an ignition failure occurs, remove the safety key from the launch control system and wait one minute before approaching the rocket. Remove the expended igniter from the engine and install a new one. Be certain the coated tip is in direct contact with the engine propellant, then tape the igniter leads firmly to base of engine as illustrated above. Repeat the countdown and launch procedure.

FOR YOUR SAFETY AND ENJOYMENT

Always follow the NAR-HIA* MODEL ROCKETRY SAFETY CODE while participating in any model rocketry activities.

*National Association of Rocketry-The Hobby Industry of America

COUNTDOWN AND LAUNCH

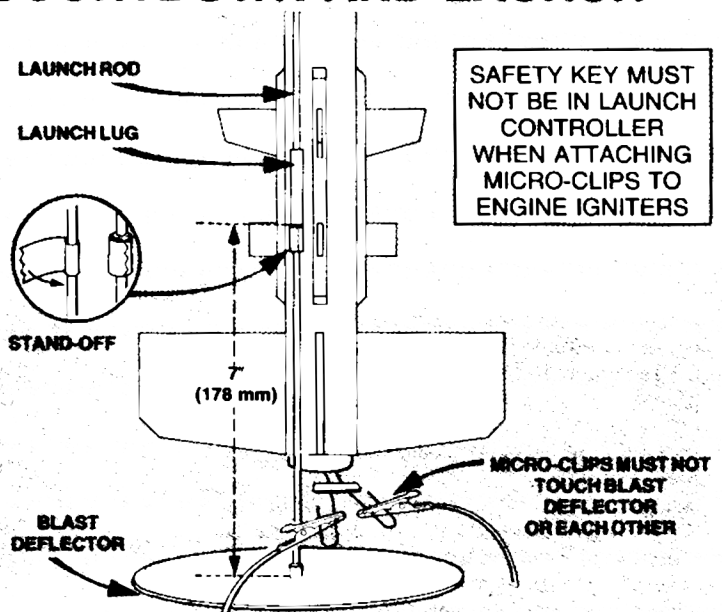

- BE CERTAIN SAFETY KEY IS NOT IN LAUNCH CONTROLLER.
- Remove safety cap and slide launch lug over launch rod to place rocket on launch pad. Make sure the rocket slides freely on the launch rod.
- Attach micro-clips to the igniter wires. Arrange the clips so they do not touch each other or the metal blast deflector. Attach clips as close to protective tape on igniter as possible.
- Move back from your rocket as far as launch wire will permit (at least 15 feet - 5 meters).
- INSERT SAFETY KEY to arm the launch controller.

Give audible countdown 5...4...3...2...1

LAUNCH!! PUSH AND HOLD LAUNCH BUTTON UNTIL ENGINE IGNITES
REMOVE SAFETY KEY FROM LAUNCH CONTROLLER. REPLACE SAFETY KEY AND SAFETY CAP ON LAUNCH ROD.

300
DPI

3/32"

No.0303SR

THE
A

29301000001-19
CENTER SECTION ASM-N-7A
SERIAL NO. AS - 3462

29301000001-19
CENTER SECTION ASM-N-7A
SERIAL NO. AS - 3462

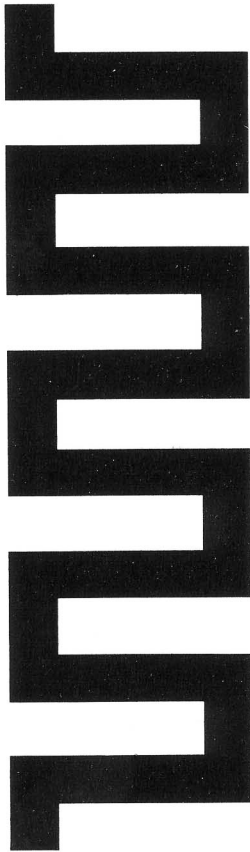

ESTES INDUSTRIES PN 037483

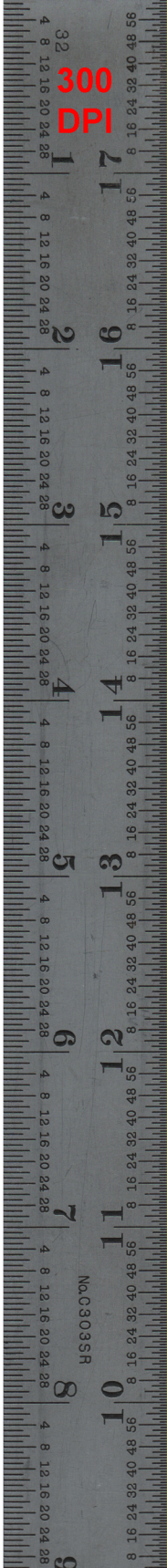
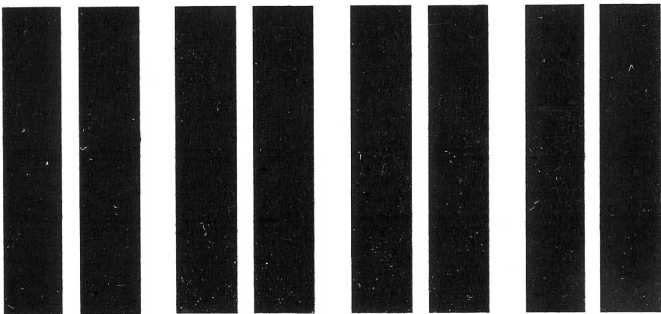
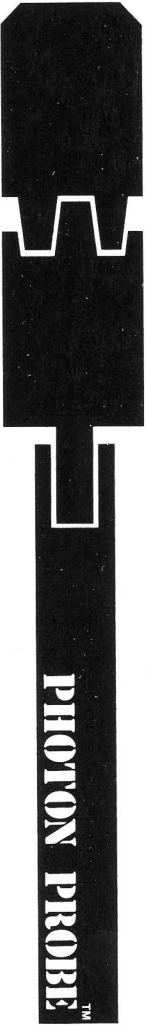
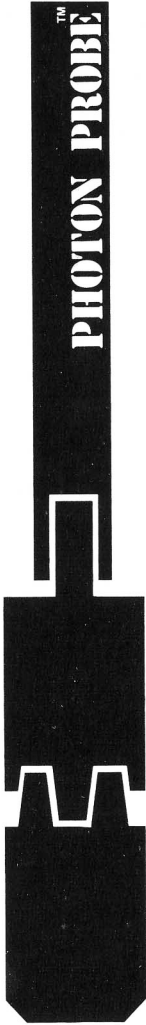

PARTS LIST KIT NO. 2043 - Photon Probe

Quantity	Description	Type	Number	Detail1	Detail2	Detail3	Detail4	Comment
1	PAPER BODY TUBE	BT-20J	30326-1	2.75" long	0.710" ID	0.736" OD	0.013" wall	Blue
1	ENGINE HOLDER	EH-2	35021	2.8" long	.100" wide	.025" thick	18/24mm	Thumb Saver
1	MYLAR RETAINER RING	HR-20	30168	0.3" long	0.74" ID	0.76" OD	0.01" wall	BT-20
1	ENGINE BLOCK	EB-20A	30224	.708" OD	.65" ID	.25" thick	0.058" wall	Black
1	PAPER ADAPTER	RA-2055	30125	0.738" ID	1.27" OD	.05" thick	Notched	
1	PAPER ADAPTER	RA-2055	30125	0.738" ID	1.27" OD	.05" thick	Not Notched	
1	PAPER BODY TUBE	BT-55	30382	18" long	1.283" ID	1.325" OD	0.021" wall	Glassine
4	Laser Cut Main Fins	*BF-2043	65067	4" wide	9" long	3/32" thick		Scan
4	Laser Cut Upper Dorsal Fins							
4	Laser Cut Lower Dorsal Fins							
1	LAUNCH LUG	LL-2B	38178	5/32" ID	1/8" rod	2-3/8" long		Mylar
1	Screw Eye (Large)	SE-1	38251	1" long				
1	BALSA NOSE CONE	BNC-55AO	70276	5.0" long	1.325" dia.	.75" shoulder		3DP zip
4	Hardwood Strip	N/A	32073	1/8" square	4" long			Basswood
1	Shock Cord	SC-2(30)	38369	1/4" wide	30" long			Elastic
1	Parachute	PK-18	35816	18" dia.	18" x 6 Shrouds		Blu/Wht	Preassembled
1	Decal	KD-2043	65204	4" wide	9" long	Blk	Waterslide	Scan
*	BALSA FIN STOCK	*BFS-30(4x9)	N/A	4" wide	9" long	3/32" thick	0.09375	

ESTES flying model rocket

SKILL LEVEL **2**

Flies Over and Over
To 700 feet (220 meters)

photon probe



Length: 29.5 in (754 mm)
Max. Dia: 3.27 in (83 mm) Weight: 2.43 oz (69 g)
Recommended Engine: A5-2 (24 grains) B4-4
(10 grains)

#2043



NO EXCITING LOADING
SPORT MODEL

ESTES flying model rocket

SAFE, FUN, EDUCATIONAL

Made in USA

35612A



This is a model kit requiring assembly. Glue and finishing supplies, launch system and engines for flight are not included.

FLIGHT SEQUENCE

LAUNCH AREA

Choose a large field away from power lines, tall trees, and low-flying aircraft. This kit uses the smallest recommended launch area.

ENGINE TYPE	ESTIMATED ALTITUDE		RECOMMENDED LAUNCH AREA
	FEET	METERS	
A	200	61	10' x 10'
B	400	122	15' x 15'
C	800	244	20' x 20'
D	1,600	488	30' x 30'
E	1,800	549	35' x 35'

Symbols indicate the following kit features:

- Parachute & Size
- Streamer Recovery
- Die-Cut Balsa Fin
- Fiber Fin
- Plastic Nose Cone
- Balsa Nose Cone
- Plastic Fin Unit
- Quick-Release Engine Mount
- Kit
- Decals

Minimum circular area = Diameter x Diameter.
Minimum rectangular area = Shorter side x longer side.

Plastic bags can be dangerous. To prevent suffocation, keep this bag away from children. Les sacs de plastique peuvent être dangereux. Pour éviter le danger de suffocation, ne laissez ce sac à la portée des bébés et des enfants.

Complete Instructions, NAR Code & Full One Year Warranty Included.

USE ONLY WITH ESTES PRODUCTS

Skill Level number recommends the modeling skill and experience necessary for a rocketeer to successfully construct the kit. Skill Level 1 kits are suggested for beginners, Skill Level 2 kits for experienced rocketeers, Skill Level 3 kits for advanced modelers, and Skill Level 4 kits are recommended for master modelers.

Estes Industries offers you more than 80 rockets, dozens including sport, scale, multi-stage, glider, payload, and science fiction models from as small as 4 inches (10 cm) high to over 1 foot (1.63 meters) tall.



Flies Over and Over
To **739** feet (226 meters)

2011
LEGO

2

photon probe



Length: 739 studs (207.4 cm) (30.2 in) (height including
measured height and starting at the
base of the probe)

LEGO BRICKS LOCKING
SHOULDER



60343

