





# NIGHT WING™

www.estesrockets.com FLYING MODEL ROCKET KIT

EST 2177



Estes Industries  
1295 H Street  
Penrose, CO 81240

PRINTED IN CHINA

## ASSEMBLY TIP

Read all instructions before beginning work on your model. Make sure you have all parts and supplies.  
**TEST-FIT ALL PARTS TOGETHER BEFORE APPLYING ANY GLUE.** If any parts don't fit properly, sand as required for precision assembly.

## PARTS

Locate the parts shown below and lay them out on the table in front of you.  
**DO NOT USE THIS DRAWING TO ASSEMBLE YOUR ROCKET.**

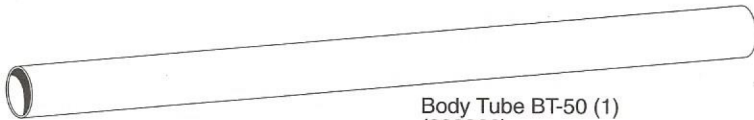
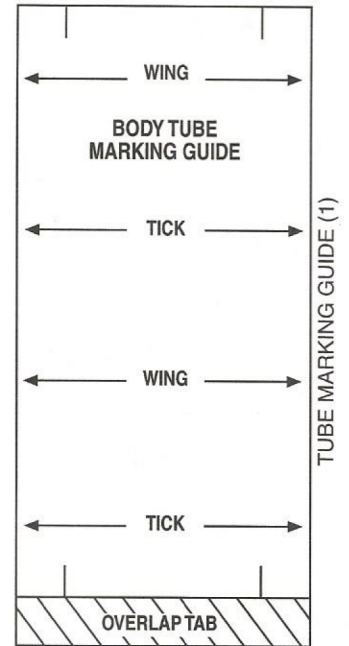

Body Tube BT-50 (1)  
(030366)

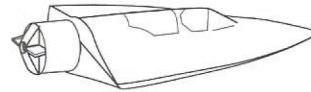

Nose Cone (1)  
(072023)



Green Centering Rings (2)  
(030164-2)

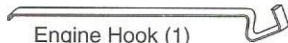

Engine Hook (1)  
(035021)



Clay Weight (1)  
(085704)



Blue Engine Mount Tube (1)  
(030326-1)

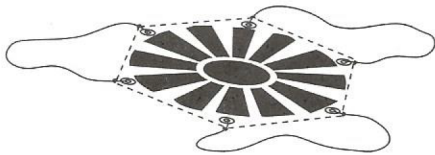

Assembled Parachute 18" (46 cm) (1)  
(035802)

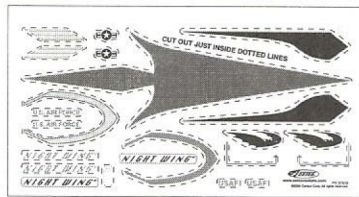

Decal Sheet (1) (037510)



Launch Lug (1)  
(038175)



Shock Cord (1)  
(038383)

Die-cut Balsa Sheet (2)  
(032248)

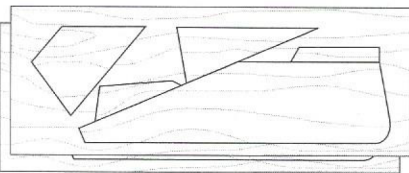

Die-cut Balsa Sheet (2)  
(032249)

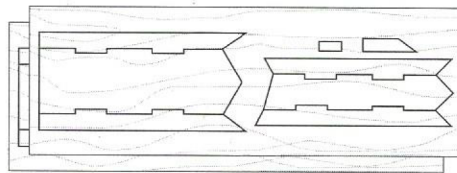

Die-cut Paper (1)  
(030131)

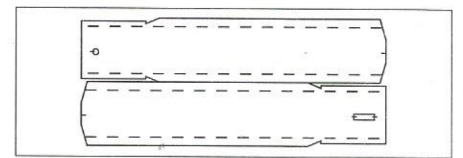

## SUPPLIES

In addition to the parts included in the kit you will also need:



SCISSORS



PENCIL



RULER



WAX PAPER



FINE SAND PAPER  
(#400-600 Grit)



CARPENTER'S GLUE



MODELING KNIFE



SPRAY PAINT:  
(GLOSS BLACK OR BLUE)



SPRAY PAINT:  
(CLEAR)  
(OPTIONAL)



SPRAY PAINT:  
(RED OR ORANGE)



MASKING TAPE



PRIMER  
(WHITE)

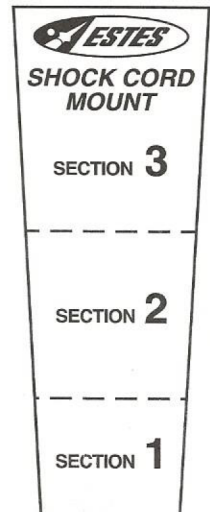

Shock Cord Mount (1)

**1. A. CUT OUT WING JIGS FROM BACK OF PANEL**

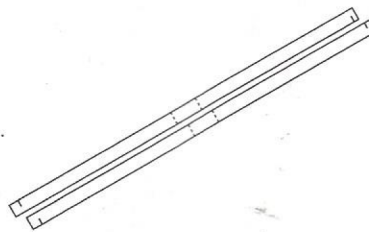
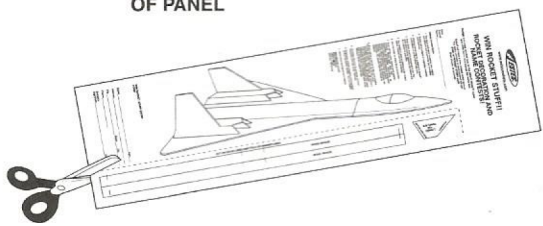

**B. 1. FOLD ON DOTTED LINES.**

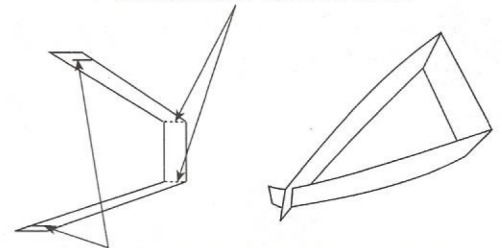

CUT SLITS ON END LINES AND JOIN TABS.

**2. A. MARK ENGINE TUBE.**

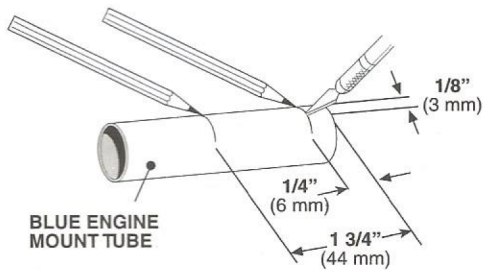

**B. POSITION HOOK.**

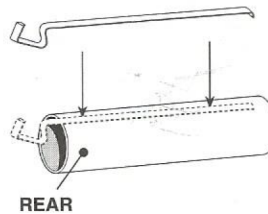

**C. APPLY GLUE AROUND TUBE AT 1 3/4" (44mm) MARK. SLIDE GREEN CENTERING RING ONTO TUBE**

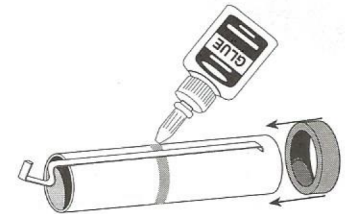

**D. APPLY GLUE AROUND FRONT OF TUBE, SLIDE GREEN CENTERING RING ONTO TUBE.**

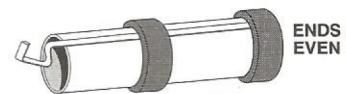
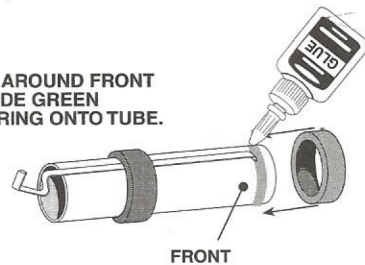

**3. A. CUT OUT LOWER FIN TEMPLATE FROM BACK OF PANEL.**

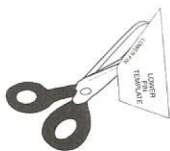

**B. 1. FINE SAND ALL BALSA SHEETS. 2. FREE FINS AND WING PIECES WITH KNIFE.**

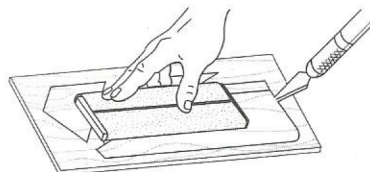

**C. SAND ALL EDGES OF EACH PIECE**

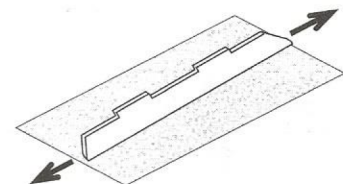

**D. GLUE WING PIECES TOGETHER. LET DRY.**

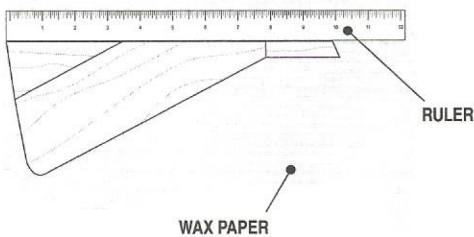

**E. LOCATE PIECES FOR BOTH WING TOP SECTIONS.**

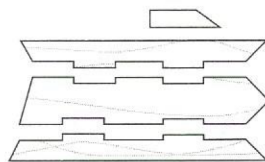

**F. ALIGN TABS WITH SLOTS AND GLUE.**

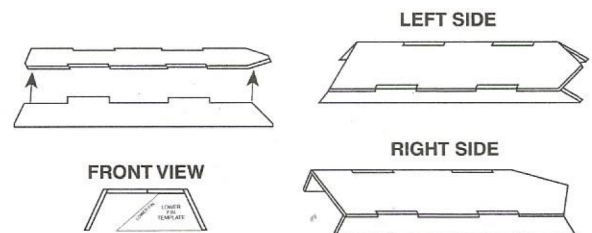

**G. GLUE REMAINING PIECE CENTERED IN FRONT. LET DRY.**

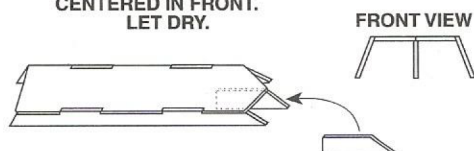

**H. LOCATE BALSA BOTTOM COVER PIECES.**

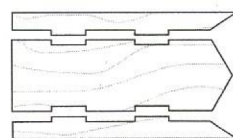

**I. ALIGN TABS WITH SLOTS AND GLUE.**

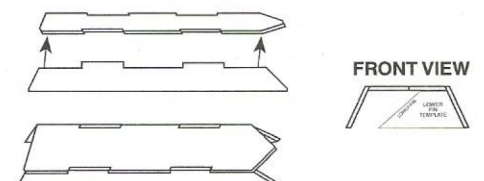

**4. A. CUT OUT TUBE MARKING GUIDE FROM FRONT PAGE.**

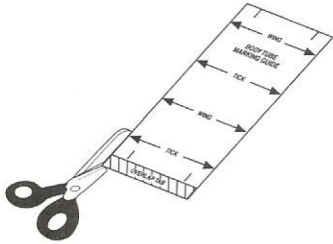

**B. TAPE TUBE MARKING GUIDE AROUND END OF BODY TUBE, MARK AT ARROWS. MARK WING LINES "WW". REMOVE GUIDE.**

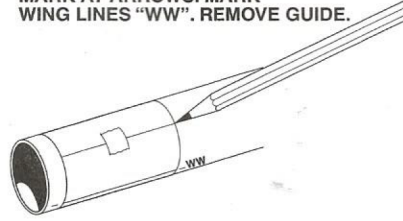

**C. CONNECT TICK & WING LINES AND EXTEND ENTIRE LENGTH OF TUBE.**

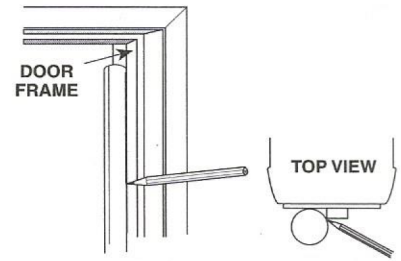

**5. A. USE FINGER TO SMEAR GLUE 2" (51 mm) INSIDE BODY TUBE.**

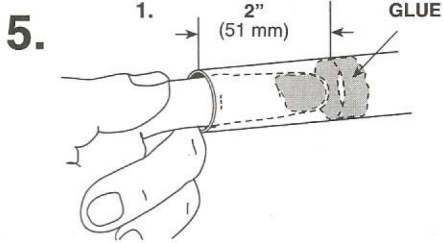

**B. INSERT ENGINE MOUNT TUBE INTO BODY TUBE.**

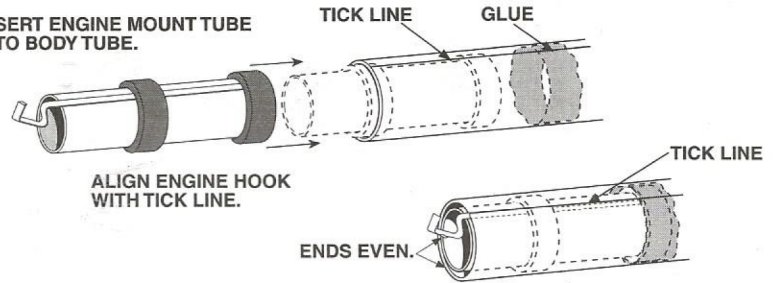

**6. A. GLUE WINGS ON WING LINES.**

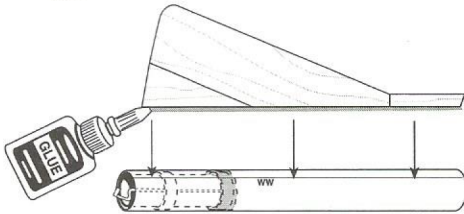

**B. TO INSURE PROPER ALIGNMENT USE WING JIGS FROM STEP 1. LET GLUE DRY.**

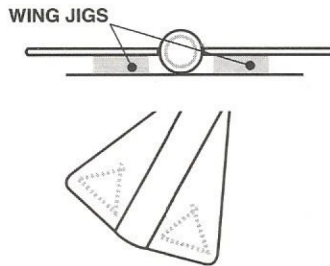

**C. WHEN JOINTS ARE DRY, DRAW STRAIGHT LINES ON TOP AND BOTTOM OF EACH WING 3/8" (10 mm) FROM BODY TUBE.**

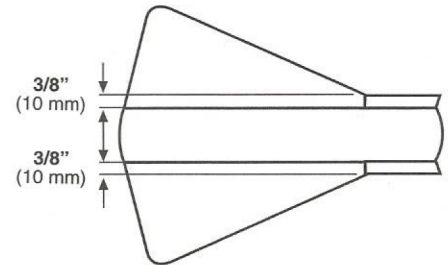

**7. A. TRIM ANY EXCESS PLASTIC FROM AROUND SIDES OF NOSE CONE.**

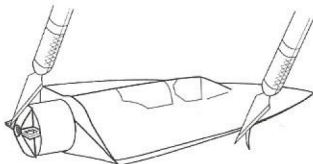

**B. USE KNIFE TO REMOVE EXCESS PLASTIC FROM REAR EYELETS.**

**C. FORM CLAY INTO "SNAKES". DROP THROUGH HOLE IN NOSE CONE.**

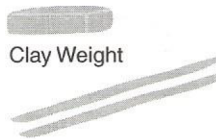

**D. USE A PENCIL TO TAMP CLAY INTO FRONT OF NOSE CONE. TAMP ALL THE CLAY INTO NOSE CONE.**

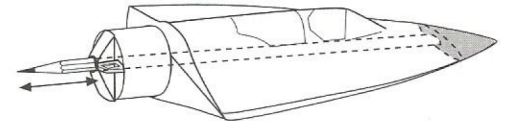

**8. A. 1. REMOVE BOTTOM SECTION FROM DIE-CUT PAPER SHEET.**

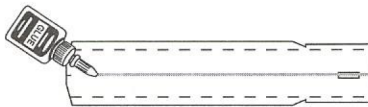

**C. SPREAD OUT THIN LINE OF GLUE WITH FINGER.**

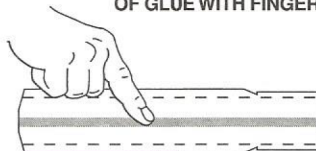

**D. ALIGN TICK MARKS WITH TICK LINE, RUB-OUT ANY WRINKLES. PAPER SECTIONS SHOULD BE EVEN WITH BOTH ENDS OF BODY TUBE.**

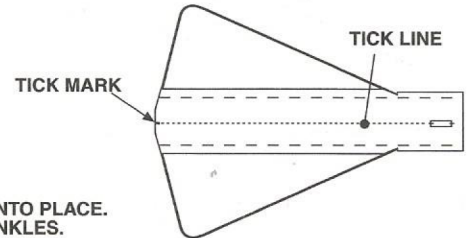

**B. RUN THIN LINE OF GLUE BETWEEN TICK MARKS.**

**E. SPREAD THIN LAYER OF GLUE UNDERNEATH FROM DASHED LINES TO OUTER EDGE OF PAPER.**

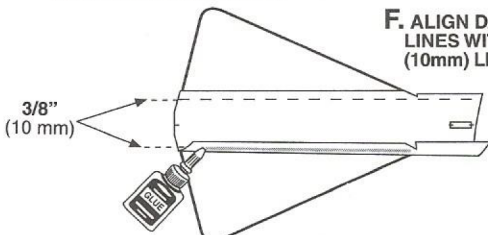

**F. ALIGN DASHED LINES WITH 3/8" (10mm) LINES ON WINGS.**

**G. PRESS BOTTOM SECTION EDGES INTO PLACE. USE FINGER TO RUB OUT ANY WRINKLES.**

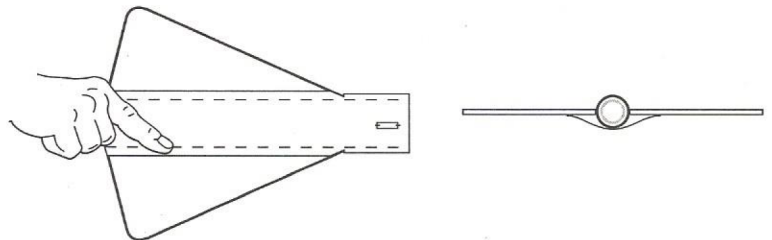

**9. A. GLUE UNDER DASHED LINE AND FOLD OVER ONTO WOOD.**

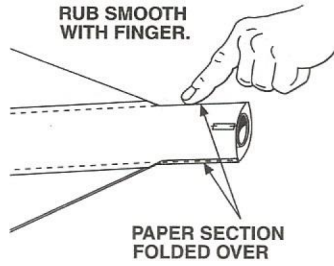
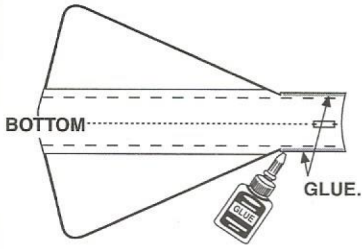

**B. GO BACK TO STEP 8, FOLLOW SAME DIRECTIONS FOR TOP SECTION.**

**C. GLUE UNDER DASHED LINE AND FOLD OVER.**

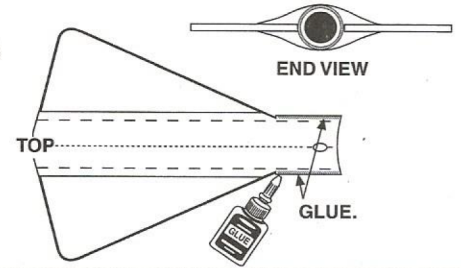

**10.**

**A. CUT OUT SHOCK CORD MOUNT FROM FRONT PAGE.**



**B. GLUE.**

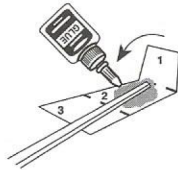

**C. FOLD FORWARD.**

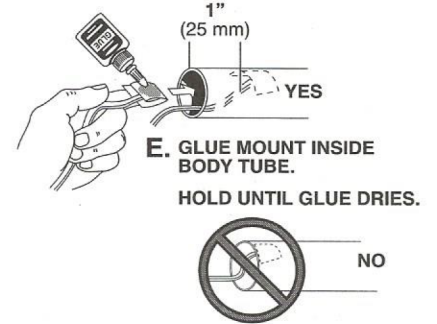
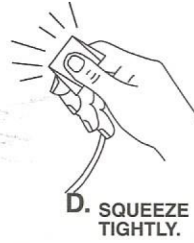
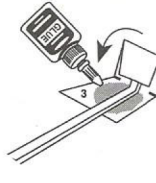

**11.**

**A.**

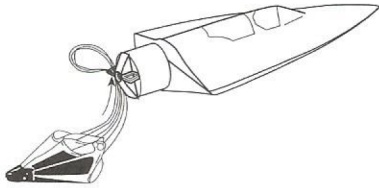

**B.**

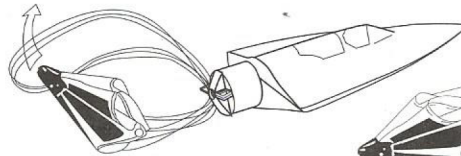

**C.**

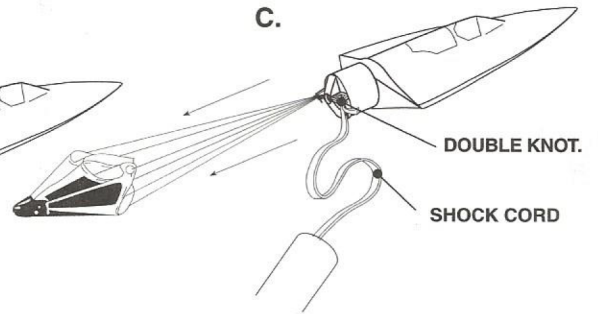

**12.**

**A. 1. GLUE BOTTOM Balsa PIECE TO BOTTOM OF BODY TUBE. ALIGN WITH OUTER EDGES OF PAPER.**

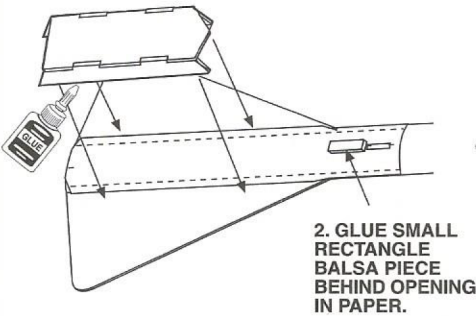

**B. 1. CUT LAUNCH LUG INTO TWO 3/4\" (19 mm) PIECES**

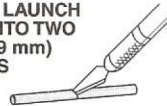

**2. GLUE LAUNCH LUG PIECES INTO PLACE.**

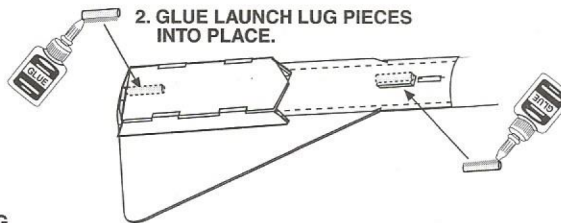

**C. GLUE EACH Balsa TOP PIECE TO TOP OF WINGS, EVEN WITH PAPER EDGES AND BACK EDGES OF WINGS.**

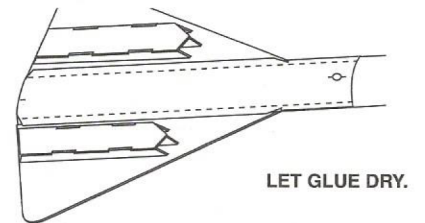

**13.**

**A. GLUE TOP FINS TO TOP Balsa PIECES.**

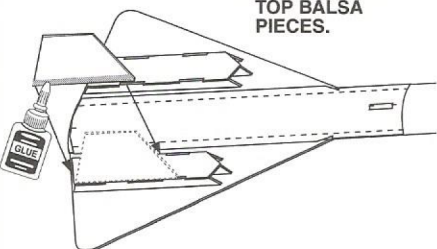

**ALIGN FINS SO THEY ARE FLUSH WITH OUTER EDGES.**

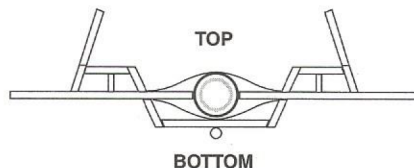

**LET FINS DRY THOROUGHLY BEFORE CONTINUING.**

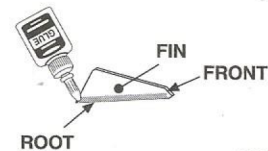

**B. USE FIN TEMPLATE FROM STEP 3 TO ALIGN AND GLUE LOWER FIN PIECES TO BACK OF BOTTOM Balsa PIECE.**

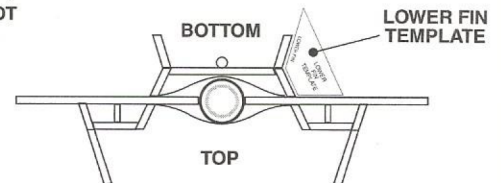

## “CONVENTIONAL” PAINT SCHEME

FIRST SPRAY ROCKET WITH WHITE PRIMER, DRY AND SAND. REPEAT UNTIL ROCKET IS SMOOTH.

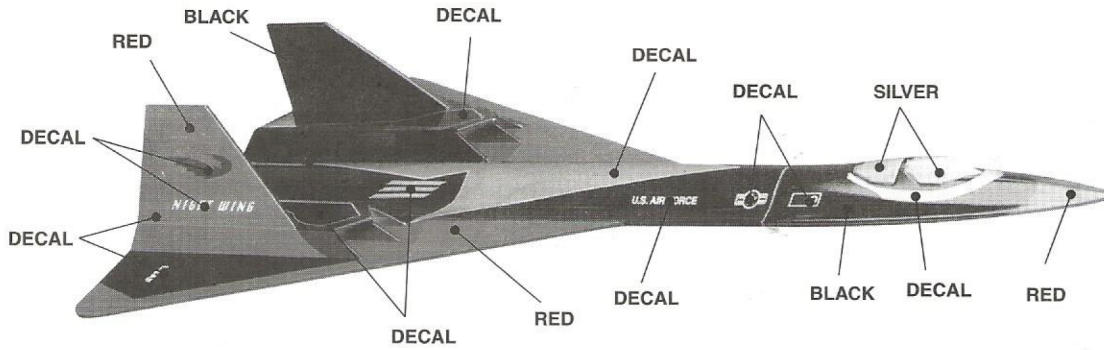

### DECALS

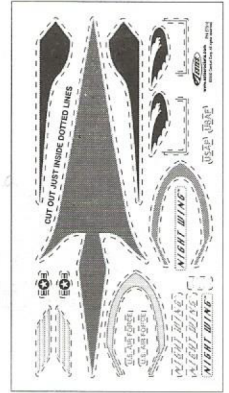

\* CLEAR COAT ENTIRE ROCKET WHEN PAINT DRIES.

## “WILD” PAINT SCHEME

FIRST SPRAY ROCKET WITH WHITE PRIMER, DRY AND SAND. REPEAT UNTIL ROCKET IS SMOOTH.

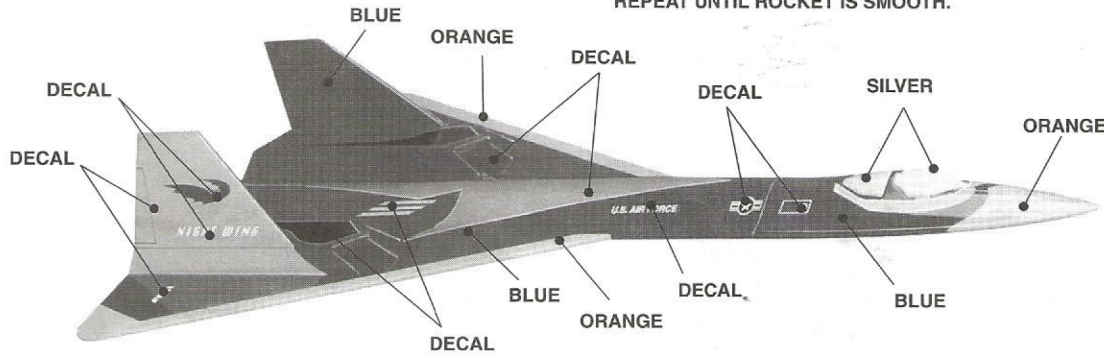

### DECALS

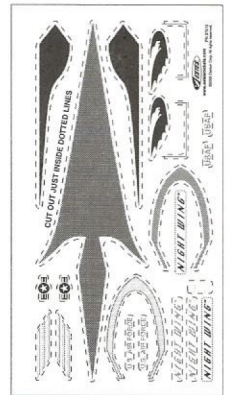

\* CLEAR COAT ENTIRE ROCKET WHEN PAINT DRIES.

## ROCKET PREFLIGHT

**A.**  
INSERT 3-4 LOOSELY CRUMPLED SQUARES OF RECOVERY WADDING.



**B.**  
SPIKE

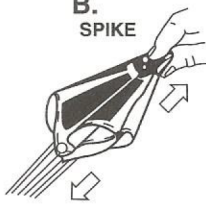

**C.**  
FOLD



**D.**  
ROLL



**E.**  
WRAP LINES LOOSELY, INSERT 'CHUTE, SHOCK CORD AND NOSE CONE.

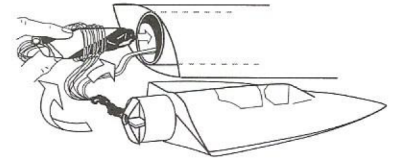

## ENGINE PREP

**WARNING: FLAMMABLE**  
Before proceeding read instructions & NAR Safety Code included with engines.

**PREPARE YOUR ENGINE ONLY WHEN YOU ARE OUTSIDE AT THE LAUNCH SITE PREPARING TO LAUNCH!**

If you do not use your prepared engine, remove the igniter before storing your engine.

**B.** TIP MUST TOUCH PROPELLANT.

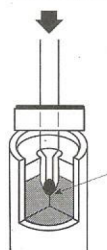

**C.**



**D.**



**E.**

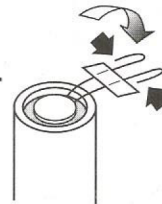

**F.** INSERT ENGINE.

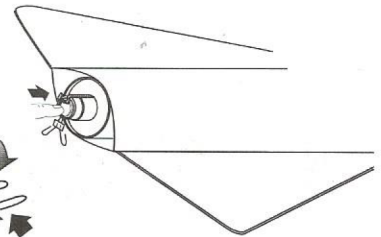

**A.**



# COUNTDOWN AND LAUNCH

## LAUNCH SUPPLIES

- Estes® Porta Pad® II and Electron Beam® Controller (Sold Separately)
- Recovery Wadding
- Igniters (w/Engines)
- Igniter Plugs (w/Engines)
- Estes® Engines: B4-4, B6-4 (First Flight), C6-5

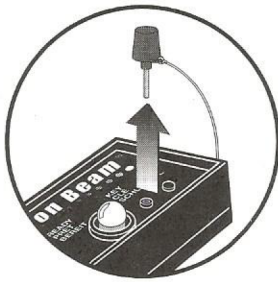

KEY ALWAYS OUT UNTIL FINAL COUNTDOWN!

1...

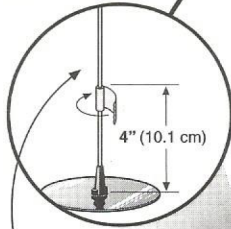

MASKING TAPE

2...



3...

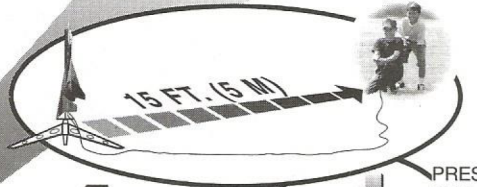
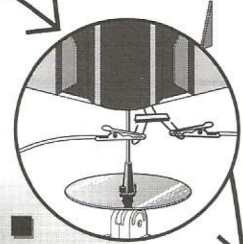

4...

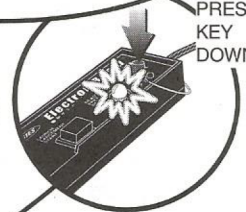

5...



HOLD KEY DOWN AND PRESS BUTTON UNTIL LIFT-OFF!

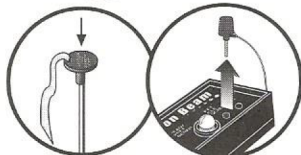

## PRECAUTIONS

NAR Safety Code

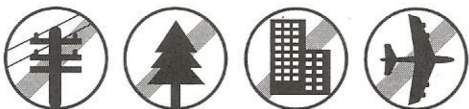

NO DRY GRASS OR WEEDS

## FLYING YOUR ROCKET

Choose a large field (500 ft. [152 m] square) free of dry weeds and brown grass. The larger the launch area, the better your chance of recovering your rocket. Football fields and playgrounds are great. Launch only with little or no wind and good visibility.

Always follow the National Association of Rocketry (NAR) SAFETY CODE.

## MISFIRES

**TAKE THE KEY OUT OF THE CONTROLLER. WAIT ONE MINUTE BEFORE GOING NEAR THE ROCKET!** Take the plug and igniter out of the engine. If the igniter has burned, it worked but did not ignite the engine because it was not touching the propellant inside the engine. Put a new igniter all the way inside the engine without bending it. Push the plug in place. Repeat the steps under Countdown and Launch.

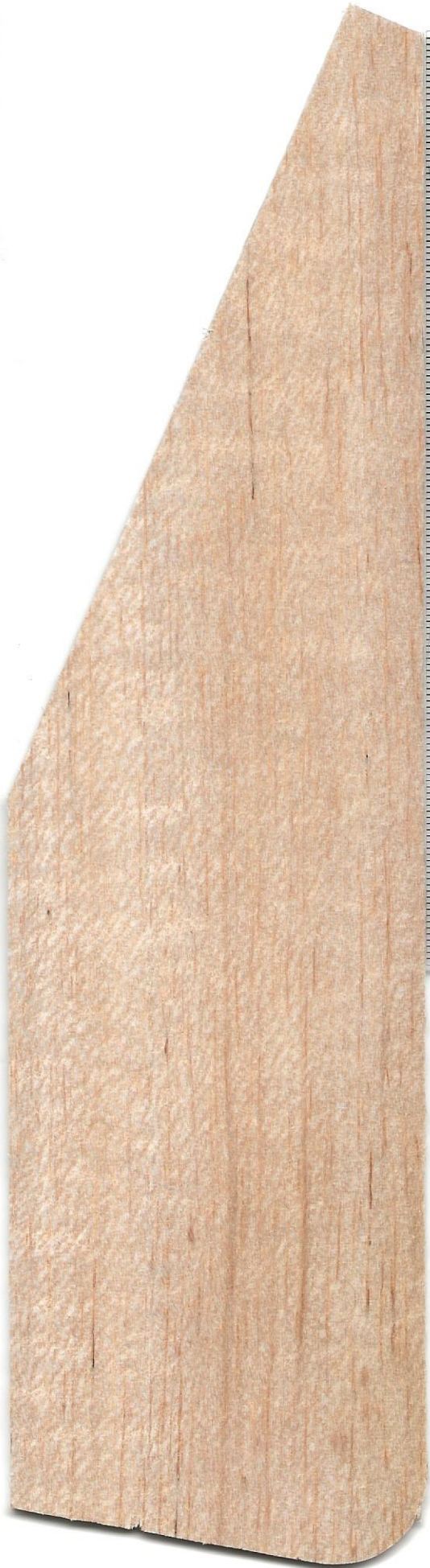



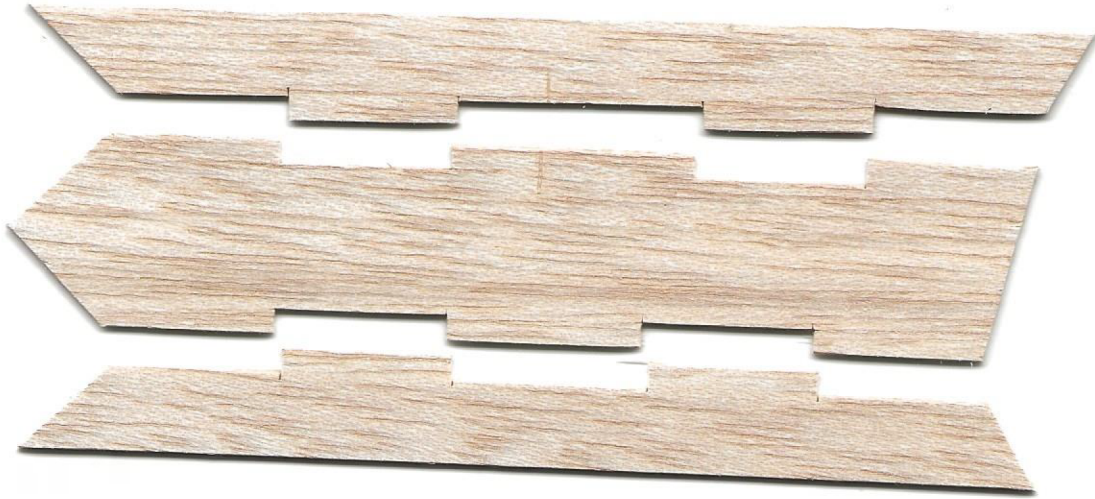
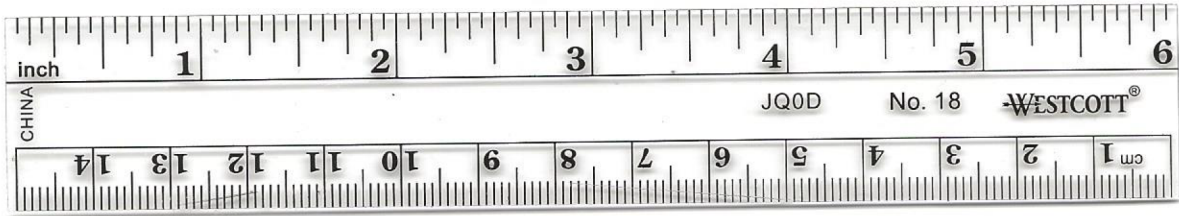
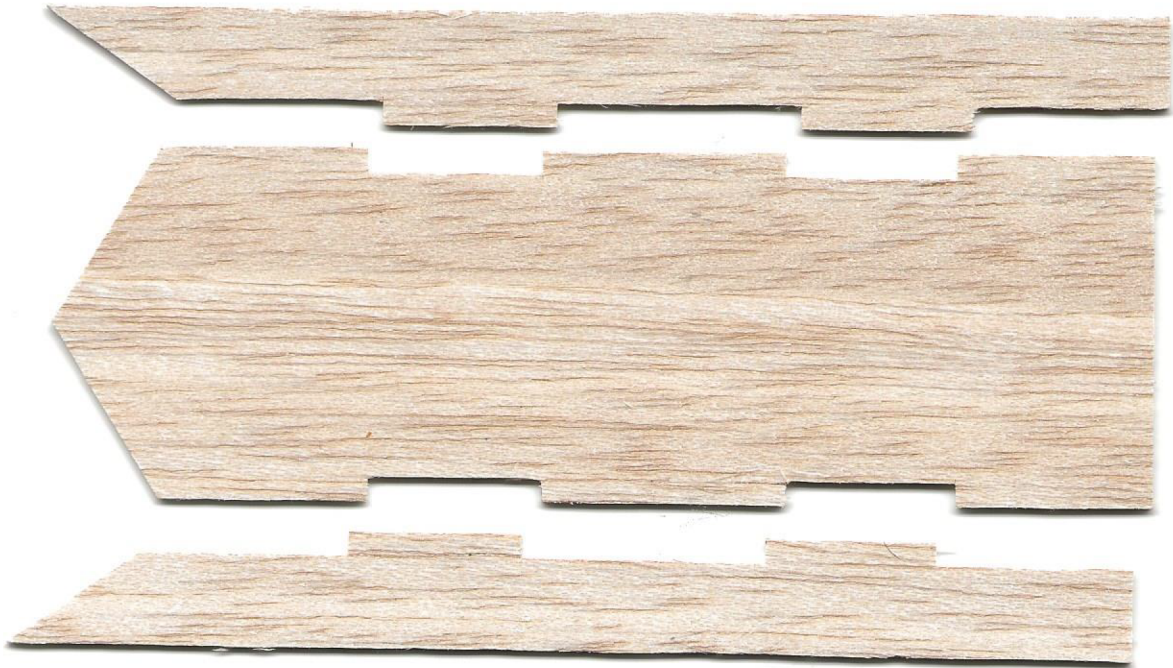

1/8"

2 sheets

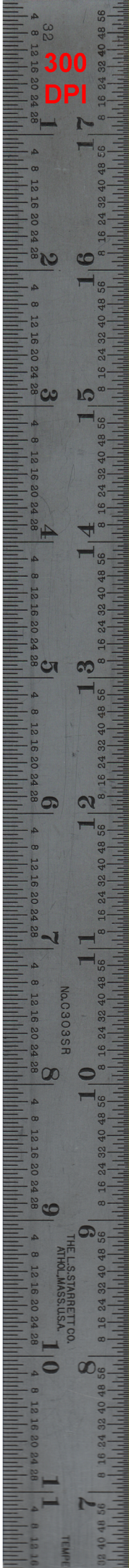
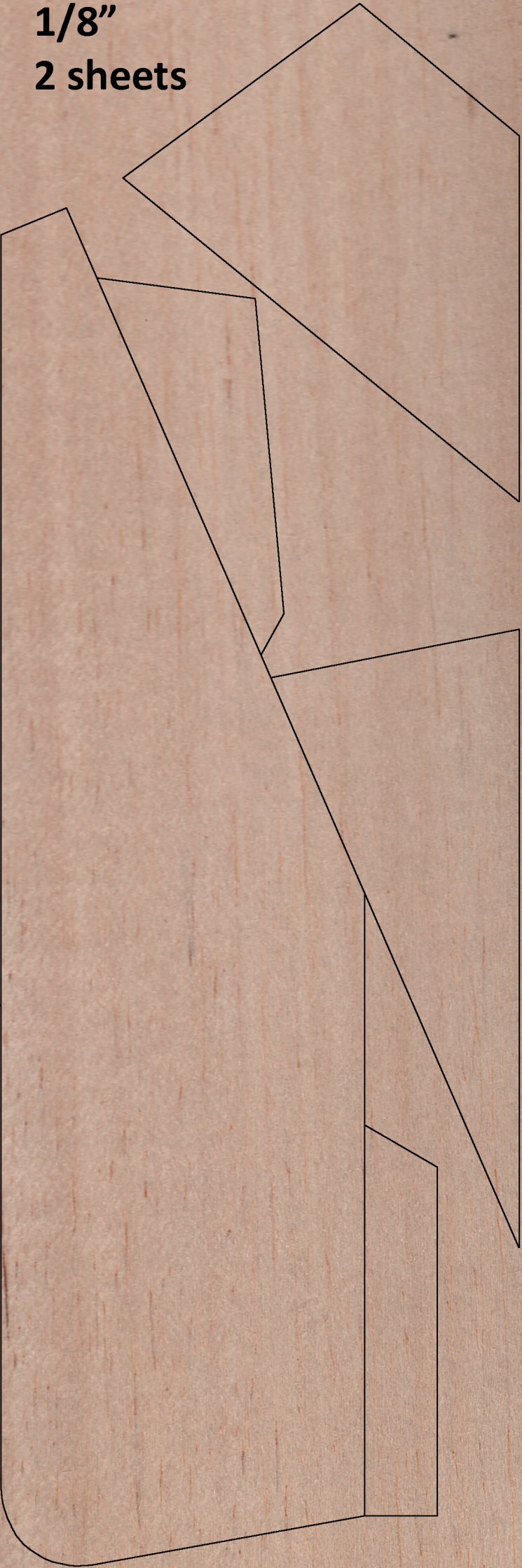



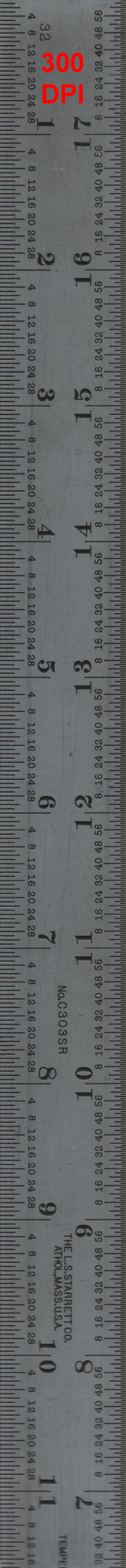

300  
DPI

No. C303SR

THE L.S. STARETT CO.  
ATHOL, MASS., U.S.A.

TEMPER

Top  
Skin



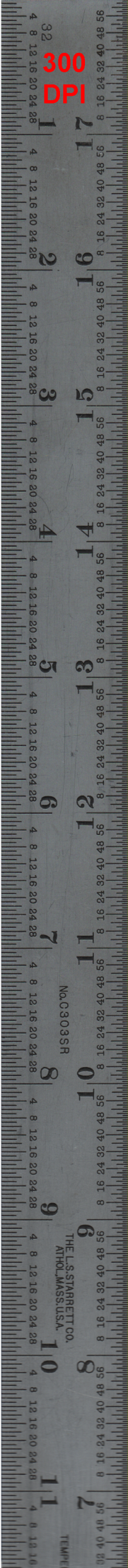

**Bottom**

**Skin**



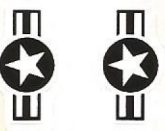
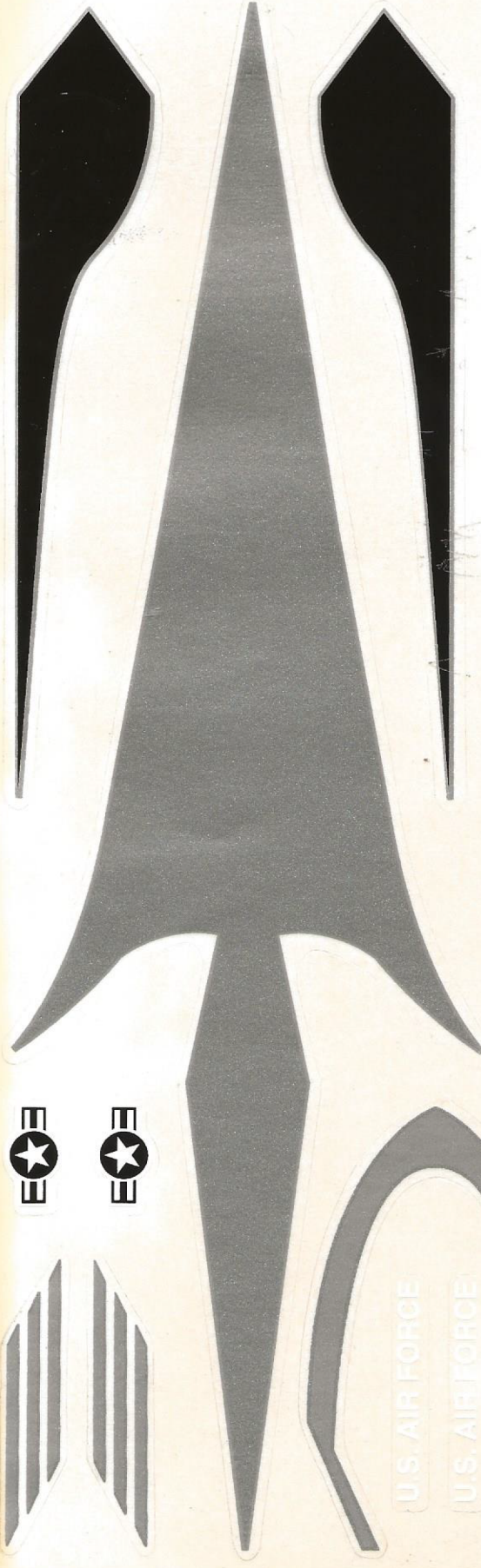

U.S. AIR FORCE  
U.S. AIR FORCE



NIGHT WING™



NIGHT WING™  
NIGHT WING™  
NIGHT WING™



Printed in China

www.estesrockets.com

PN 37510

©2000 Centuri Corp. All rights reserved.



300  
DPI

MA0303SR

THE U.S. STARLINE  
ARTHELMASS

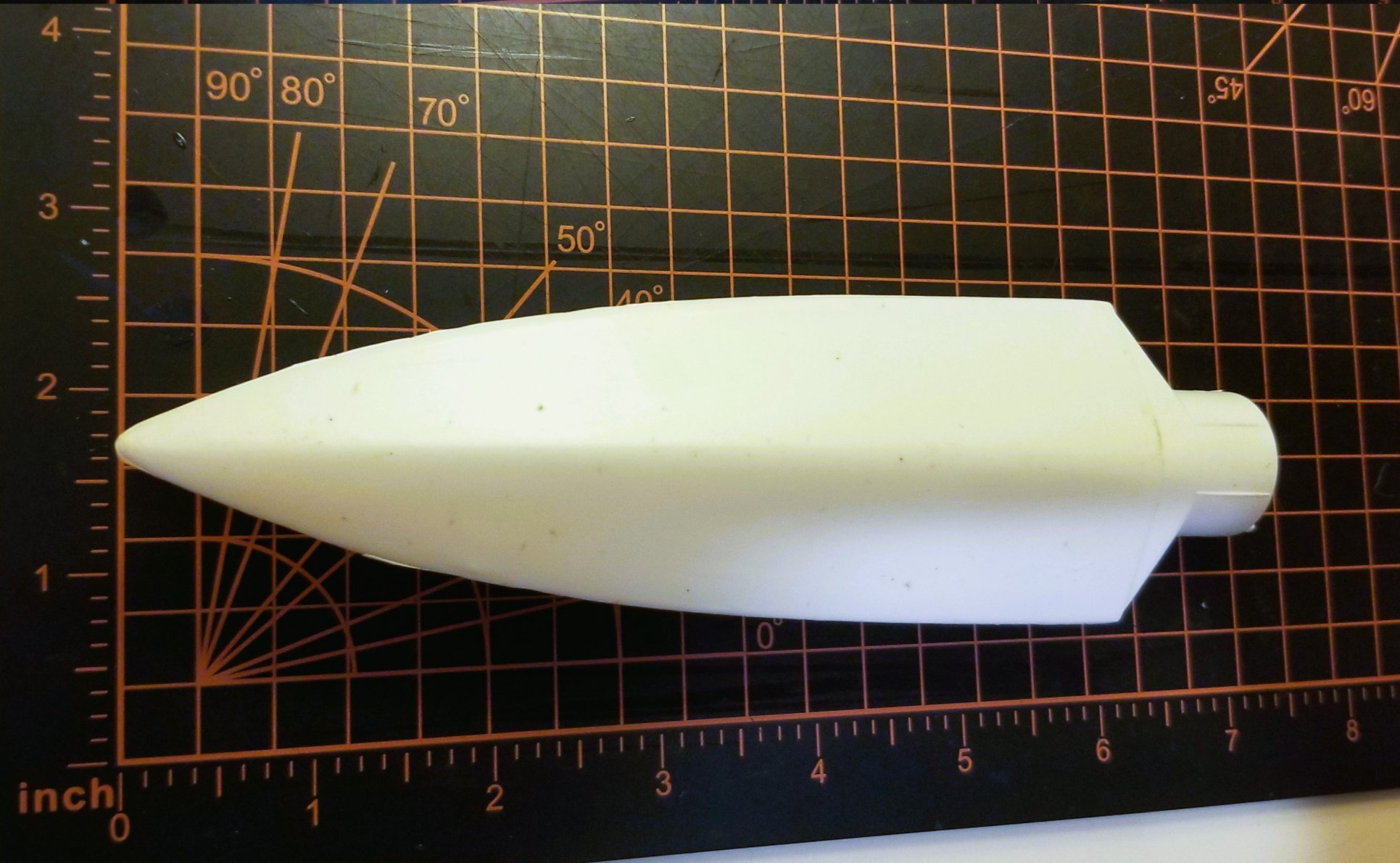
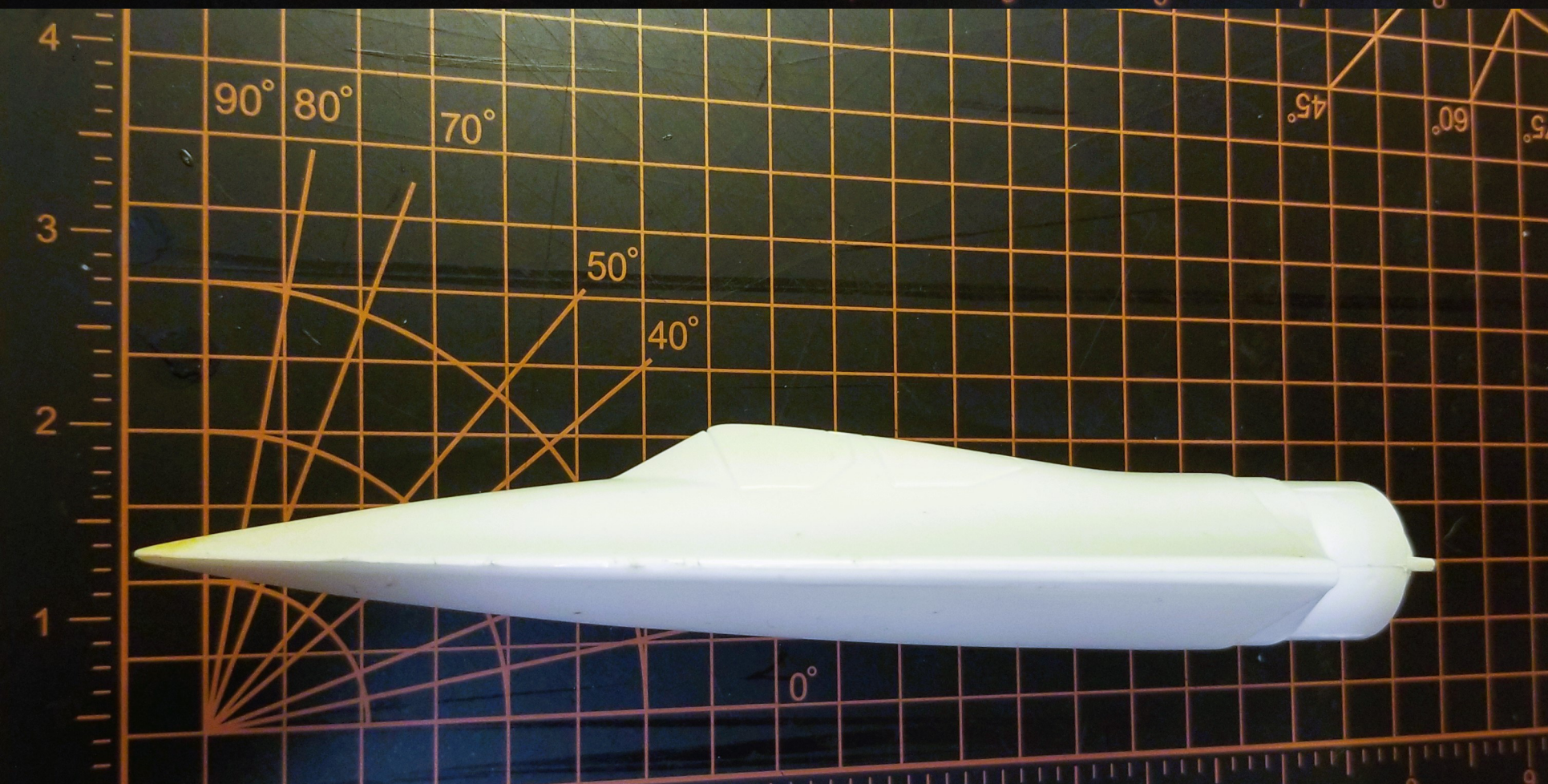

## PARTS LIST KIT NO. 2177 - Night Wing

Quantity	Description	Type	Number	Detail1	Detail2	Detail3	Detail4	Comment
1	PAPER BODY TUBE	BT-50(12.75)	30366	12.75" long	0.950" ID	0.976" OD	0.013" wall	Glassine
1	PLASTIC NOSE CONE	PNC-50?	72073	5.8" long	SR-71 style	1" Shoulder	BT-50 - Custom	Injection Molded White
2	ADAPTER RING	AR-2050	30164-2	1/4" long	.737" ID	.949" OD	0.106" wall	Green
1	ENGINE HOLDER	EH-2	35021	2.8" long	.100" wide	.025" thick	18/24mm	Thumb Saver
1	NOSE CONE WEIGHT	CNCW	85704	1" wide	1" high	0.25" thick	.25 oz.	CLAY
1	PAPER BODY TUBE	BT-20J	30326-1	2.75" long	0.710" ID	0.736" OD	0.013" wall	Blue
1	Parachute	PK-18A	35802	18" dia.	18" x 6 Shrouds	LDPE plastic	Blu/Wht	Preassembled
1	Decal	SD-2177	37510	5" wide	10" long	Blk,Wht,Slvr,Org	Selfstick	Scan
1	LAUNCH LUG	LL-2A	38175	5/32" ID	1/8" rod	1.25" long		Mylar
1	Shock Cord	SC-2?	38383	1/4" wide	24" long			Elastic
2	Diecut Balsa	BF-2177a	32248	4" wide	12" long	1/8" thick	BFS-40	Scan
2	Diecut Balsa	BF-2177b	32249	3" wide	12" long	3/32" thick	BFS-30	Scan
1	Diecut skins	SP-2177	30131	*See Notes	13" long	Heavy Paper		Scan
*Top Skin is 2.8" wide								
*Bottom Skin is 2.7" wide								



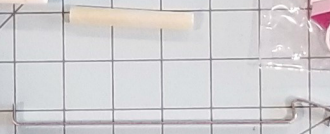

60°



18in x 12in  
57.2mm x 300mm

Store flat do not roll.  
Avoid exposure to heat and direct sunlight.  
Cut on different parts of mat to extend its life.

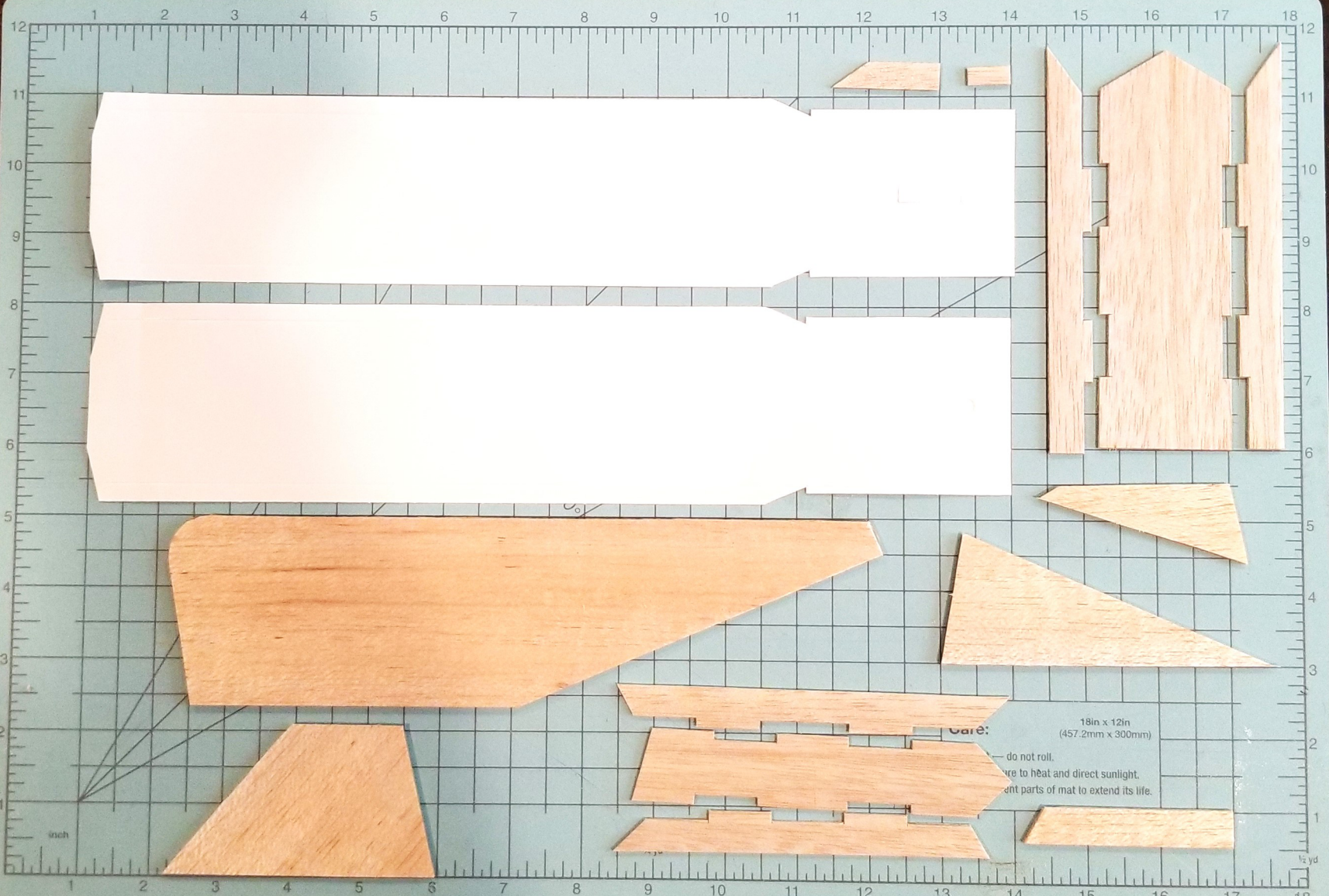

**Care:**

- do not roll.
- do not expose to heat and direct sunlight.
- do not use sharp objects on any part of mat to extend its life.

18in x 12in  
(457.2mm x 300mm)

inch

# ESTES

Recommended for ages 10 and up with adult supervision for those under 12.  
Recommandé pour enfants de 10 ans et plus. Sous la supervision des adultes pour ceux de moins de 12 ans.

## ESTES

www.estesrockets.com

### FLYING MODEL ROCKET

# ROCKET™

## NIGHT WING™

- SLEEK SUPER SPY PLANE!
- FLIES TO 650' (198 M)!
- ONE ROCKET - MANY DESIGNS!



DESIGN YOUR OWN WILD LOOK AS SHOWN!

**WIN**  
ROCKET STUFF  
DETAILS INSIDE!

Length: 19 in. (48.3 cm)  
Diameter: .28 in. (24.9 mm)  
Weight: 3.2 oz. (90.7 g)  
Recovery: 1.8 in. (46 cm)  
Parachute  
Recommended Engines: B4-4, B6-4 (Finn Figno), C6-5

Assembly required.  
Glue, finishing supplies,  
and launch supplies  
not included.

1 MODÈLE REQUIERT  
PEINTURE ET COLLE  
NON COMPRIS.

ESTES INDUSTRIES  
1295 H Street  
Penrose, CO 81240

MADE IN CHINA  
EST 2177



(1000) PN 83421

# ESTES

Recommended for ages 10 and up with adult supervision for those under 12.  
Recommandé pour enfants de 10 ans et plus. Sous la supervision des adultes pour ceux de moins de 12 ans.

## ESTES

### ESTES FLYING MODEL ROCKET ESTES MODÈLE DE FUSÉE VOLANT

Plastic bags can be dangerous. To avoid danger of suffocation, keep this bag away from babies and children.  
Les sacs de plastique peuvent être dangereux. Pour éviter le risque de suffocation, ne laissez pas ce sac à la portée des bébés et des enfants.

This model kit requires assembly. Requires white or yellow glue and/or tube-type plastic cement, paint, finishing supplies, launch igniters, wadding, and launch system - NOT INCLUDED.

Cette modèle requiert assemblage. Comprend peinture, matériel et système de lancement - NON COMPRIS.

USE ONLY WITH ESTES PRODUCTS  
Caution: Use of this Estes product with any other brand name product containing any defect or causing any damage may void the Estes warranty.

CET ENSEMBLE DOIT ÊTRE UTILISÉ AVEC DES PRODUITS ESTES UNIQUEMENT. Mise en garde: L'utilisation de ce produit Estes avec un produit d'une autre marque-estache d'une défectuosité ou causant des dommages peut annuler la garantie Estes.

Safety Code and Full One Year Warranty Enclosed.  
Code de sécurité et garantie comprises.

## ESTES

Estes Industries  
1295 H Street  
Penrose, CO 81240 USA

Made in China  
Fabrique en Chine

© 1999 Centuri Corp.

www.estesrockets.com

10-00177N 35012



www.estesrockets.com

# WIN ROCKET STUFF!! ROCKET DECORATION AND NAME CONTESTS!

Design and color another look for the NIGHT WING™ rocket and while you're at it change the name too!

Estes® will have a new contest every quarter. The lucky winners of each contest will get \$100\* of ROCKET STUFF each (their choice, of course)!

New Rocket Name \_\_\_\_\_

### Official Contest Rules

1. The decor and name should be new, original and different and created by one youngster.
2. Entries will be judged on originality, creativity and neatness.
3. Winning entries may be published in Estes® publications or on the Estes® web sites.
4. Entry forms must be completed in full. The entry form must be signed by the entrant and by a parent or guardian.
5. The contest is open to children in the United States, Canada and U.S. territories.
6. You may enter as many times as you like.
7. There will be a new contest every quarter (January - March, April - June, July - September and October - December). All entries reaching Estes Industries during each quarter will be entered in that quarter's contests. Date of receipt, not postmark, will determine the quarter that the design is entered.
8. There will be a winner for the most creative rocket decoration and one for the most innovative name. \*Each winner will receive a \$100 (US) merchandise gift certificate redeemable at Estes Industries for the rocket stuff of their choice at full Estes® retail prices. Winners will be notified by mail.
9. All entries become the property of Estes Industries and will not be returned.
10. Employees of Estes Industries and members of their immediate families are not eligible.
11. Send entries (package panel or copy) to:

**WIN ROCKET STUFF**  
Estes Industries  
1295 H Street  
Penrose, CO 81240

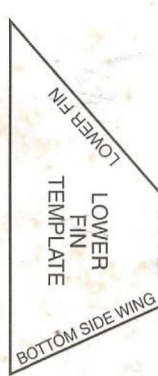
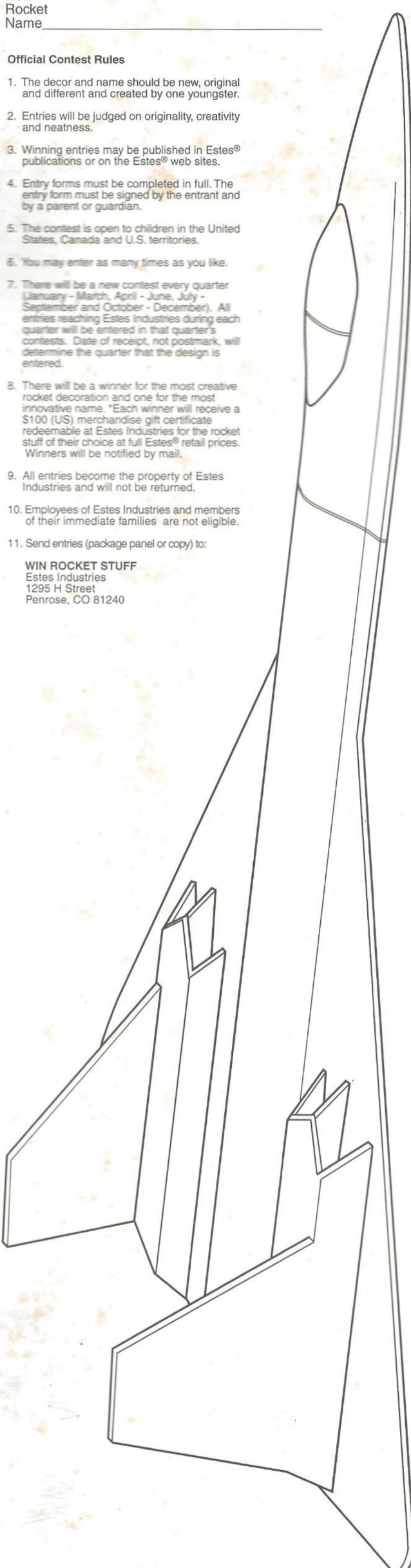

CUT ON SOLID LINES AND FOLD ON DASHED LINES.

### WIN ROCKET STUFF ENTRY FORM

Name \_\_\_\_\_ Age \_\_\_\_\_

Address \_\_\_\_\_

City \_\_\_\_\_ State \_\_\_\_\_ Zip \_\_\_\_\_

Phone \_\_\_\_\_

Entrant's Signature \_\_\_\_\_ Date \_\_\_\_\_

Parent's/Guardian's Signature \_\_\_\_\_ Date \_\_\_\_\_

(Contest and contest rules subject to change or cancellation without notice.)





www.estesrockets.com

FLYING MODEL

# ROCKET™

SKILL LEVEL 3

## NIGHT WING™

- SLEEK SUPER SPY PLANE!
- FLIES TO 650 FT. (198 M)!
- ONE ROCKET - MANY DESIGNS!



DESIGN YOUR OWN **WILD** LOOK AS SHOWN!

U.S. AIR FORCE

**WIN**  
ROCKET STUFF!  
DETAILS INSIDE

Length: 19 in. (48.3 cm)  
 Diameter: .98 in. (24.9 mm)  
 Weight: 3.2 oz. (90.7 g)  
 Recovery: 18 in. (46 cm)  
 Parachute  
 Recommended Engines:  
 B4-4, B6-4 (First Flight), C6-5

Assembly required.  
 Glue, finishing supplies,  
 and launch supplies -  
 not included.

1 MODÈLE RÉDUIT.  
 PEINTURE ET COLLE  
 NON COMPRIS.

ESTES INDUSTRIES  
 1295 H Street  
 Penrose, CO 81240

MADE IN CHINA

EST 2177



0 47776 02177 8



Official Rockets of  
 U.S. Space Camp  
 800-63-SPACE