



Astron

CHEROKEE-D

ESTES
A SUBSIDIARY OF DAMON

**"D" POWER FOR LARGE PAYLOAD CAPACITY
FOR HIGH ALTITUDE PERFORMANCE**

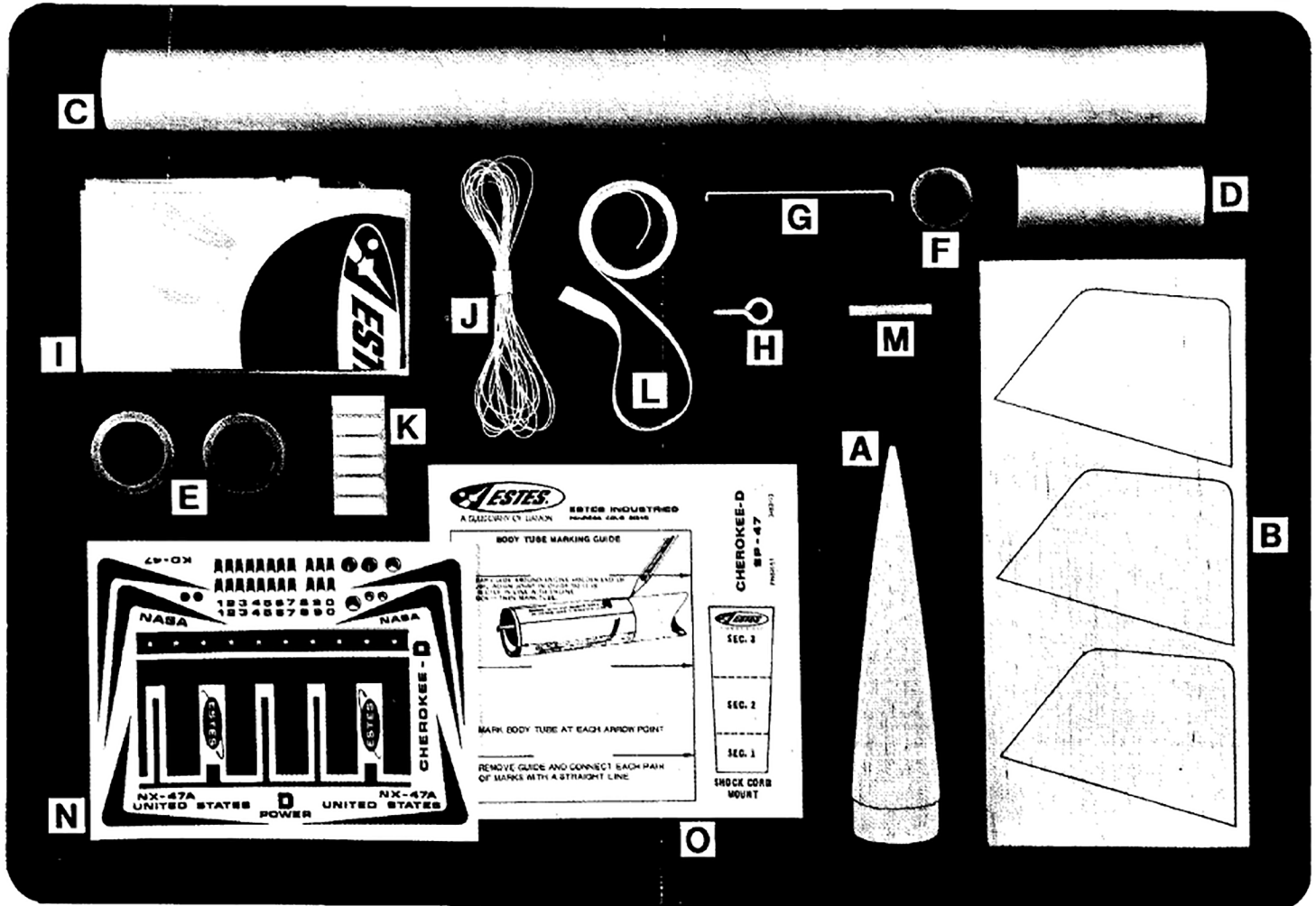

PARTS LIST

A	1	Nose Cone	Part #BNC-55AC
B	1	Die Cut Fin Set	#BF-47
C	1	Body Tube	#BT-55V
D	1	Body Tube	#BT-50J
E	2	Spacing Rings	#AR-5055
F	1	Spacing Ring	#AR-2050
G	1	Engine Holder	#EH-2
H	1	Screw Eye	#SE-2
I	1	18" Parachute	#PK-18A
J	1	108" Shroud Line	#SLT-108
K	6	Tape Strips	#TD-2F
L	1	1/4" Shock Cord	#SC-2
M	1	Launch Lug	#LL-2A
N	1	Decal Sheet	#KD-47
O	1	Pattern Sheet	#SP-47

In addition to the materials included in your kit you will also need the following tools and materials:

- 1) Modeling knife or single edge razor blade
- 2) Scissors
- 3) Extra-strong white glue
- 4) Ball point pen or pencil
- 5) Fine and extra fine grit sandpaper
- 6) Paint or dope

NOTE: Never apply dope over spray enamels as it will ruin the finish.

Read the entire assembly instructions carefully before beginning work on your model rocket. Start construction, following each step, in order, checking off each step as it is completed.

RECOMMENDED ENGINES
D13-5, D13-7

WITH ADAPTER EM-2050
B6-4, C6-5

COUNTDOWN CHECKLIST

- 14 Pack six or seven squares of crumpled recovery wadding loosely into body tube.

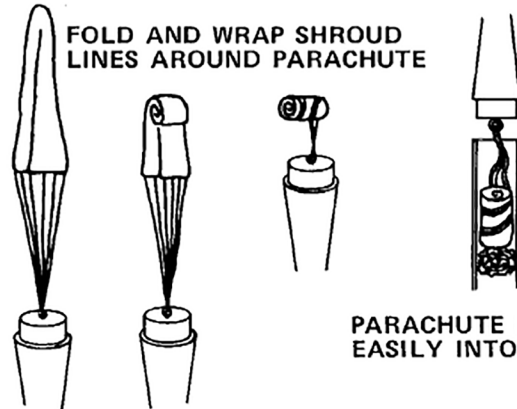

FOLD AND WRAP SHROUD LINES AROUND PARACHUTE

PARACHUTE MUST SLIDE EASILY INTO ROCKET

- 13 Fold the parachute into a triangular shape. Roll 'chute tightly as shown and wrap shroud lines around it. If 'chute is too large, unroll and repack until it slides easily into rocket. A very tight fit may prevent parachute from ejecting properly. Slide nose cone into place. Nose should separate easily from rocket body tube, but not be extremely loose. If fit is too tight, sand inside of body tube end and shoulder of nose cone with extra fine sandpaper.

- 12 Pack shock cord neatly into rocket. NOTE: DO NOT pack parachute until you are actually ready to launch. For maximum parachute reliability, lightly dust the 'chute with ordinary talcum powder before each flight, especially in cold weather.

If nose cone is too loose, add a wrapping of transparent tape or masking tape to the shoulder of the nose cone.

- 11 Select an engine and install an igniter as directed in the engine instructions. Engines recommended for use with this rocket are D13-5 and D13-7 or (with adapter EM-2050) B6-4 and C6-5.

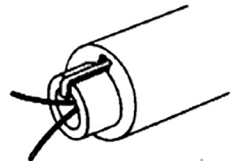

- 10 Insert engine into rocket. Engine hook must latch securely over the end of the engine.

- 9 Disarm the launch panel--remove safety key.

- 8 Place rocket on launch pad making sure rocket slides freely on launch rod. Clean the micro-clips and attach them to the igniter.

- 7 Clear the launch area, alert recovery crew and trackers. Check for low flying aircraft and unauthorized persons in the recovery area.

- 6 Arm the launch panel--insert safety key.

- 5 4 3 2 1 LAUNCH!

MISFIRE PROCEDURE:

Occasionally the igniter will heat and burn in two without igniting the engine. This is almost always caused by a failure to install it correctly. Disarm the launch panel, remove the model, clean the igniter residue from the nozzle, and install a new igniter. Follow the launching procedure again.

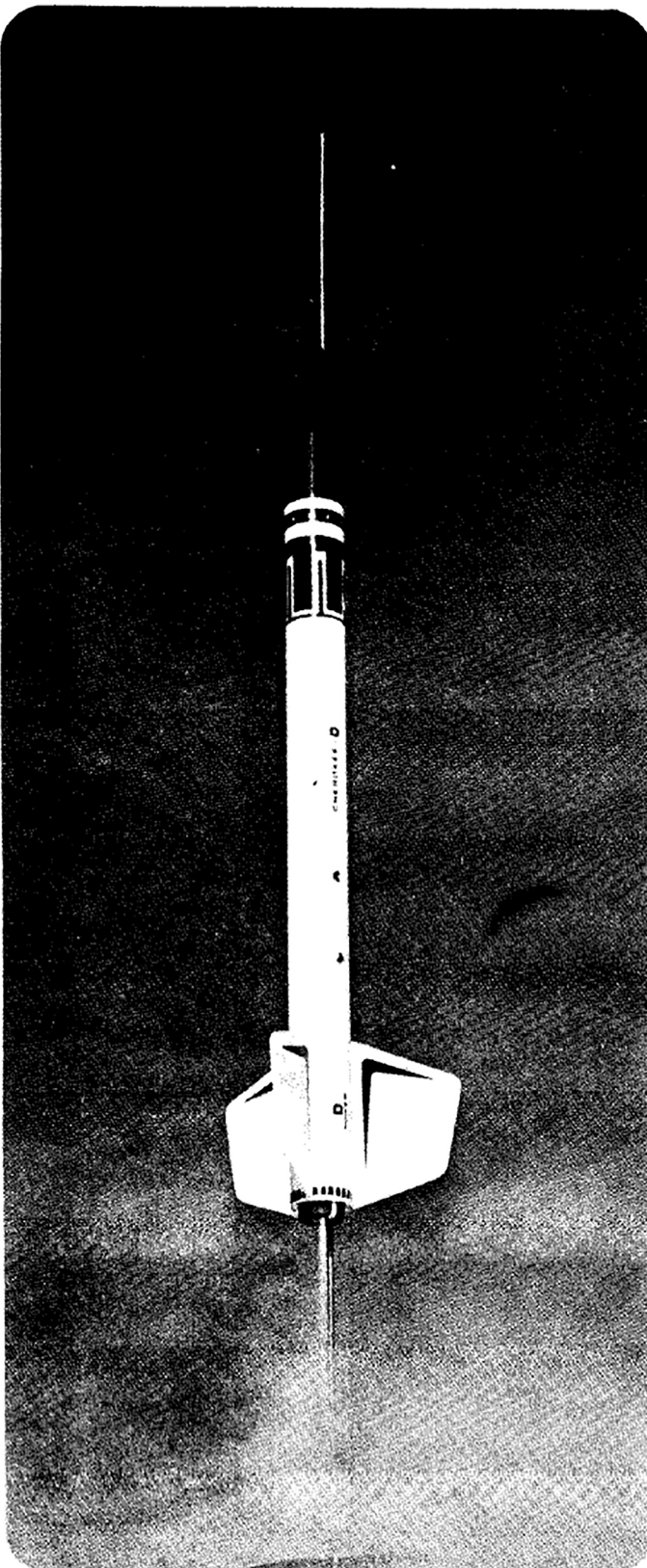

A SUBSIDIARY OF DAMON

ESTES INDUSTRIES

PENROSE, COLO. 81240

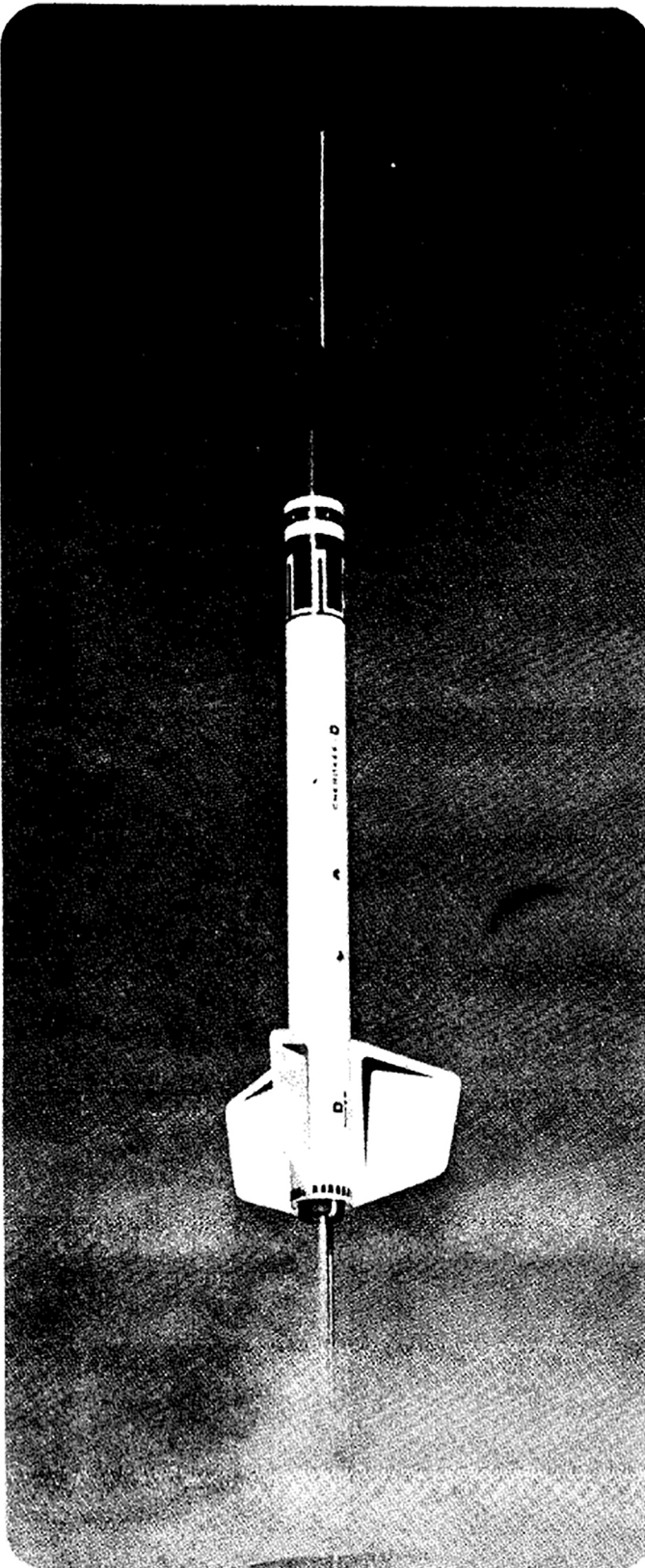

A SUBSIDIARY OF DAMON

ESTES INDUSTRIES
PENROSE, COLO. 81240

COUNTDOWN CHECKLIST

14 Pack six or seven squares of crumpled recovery wadding loosely into body tube.

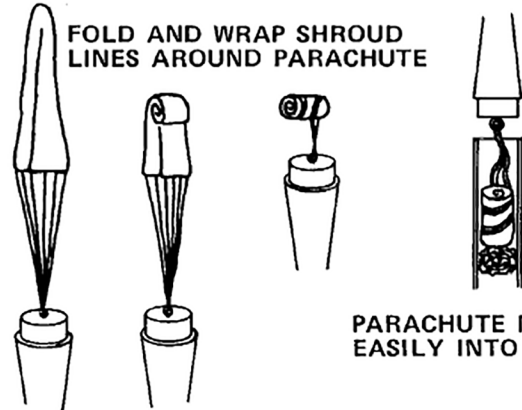

FOLD AND WRAP SHROUD LINES AROUND PARACHUTE

PARACHUTE MUST SLIDE EASILY INTO ROCKET

13 Fold the parachute into a triangular shape. Roll chute tightly as shown and wrap shroud lines around it. If chute is too large, unroll and repack until it slides easily into rocket. A very tight fit may prevent parachute from ejecting properly. Slide nose cone into place. Nose should separate easily from rocket body tube, but not be extremely loose. If fit is too tight, sand inside of body tube end and shoulder of nose cone with extra fine sandpaper.

12 Pack shock cord neatly into rocket. NOTE: DO NOT pack parachute until you are actually ready to launch. For maximum parachute reliability, lightly dust the chute with ordinary talcum powder before each flight, especially in cold weather.

If nose cone is too loose, add a wrapping of transparent tape or masking tape to the shoulder of the nose cone.

11 Select an engine and install an igniter as directed in the engine instructions. Engines recommended for use with this rocket are D13-5 and D13-7 or (with adapter EM-2050) B6-4 and C6-5.

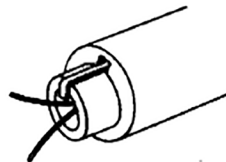

10 Insert engine into rocket. Engine hook must latch securely over the end of the engine.

9 Disarm the launch panel—remove safety key.

8 Place rocket on launch pad making sure rocket slides freely on launch rod. Clean the micro-clips and attach them to the igniter.

7 Clear the launch area, alert recovery crew and trackers. Check for low flying aircraft and unauthorized persons in the recovery area.

6 Arm the launch panel—insert safety key.

5 4 3 2 1 LAUNCH!

MISFIRE PROCEDURE:

Occasionally the igniter will heat and burn in two without igniting the engine. This is almost always caused by a failure to install it correctly. Disarm the launch panel, remove the model, clean the igniter residue from the nozzle, and install a new igniter. Follow the launching procedure again.

Astron

CHEROKEE-D



A SUBSIDIARY OF DAMON

"D" POWER FOR LARGE PAYLOAD CAPACITY
FOR HIGH ALTITUDE PERFORMANCE

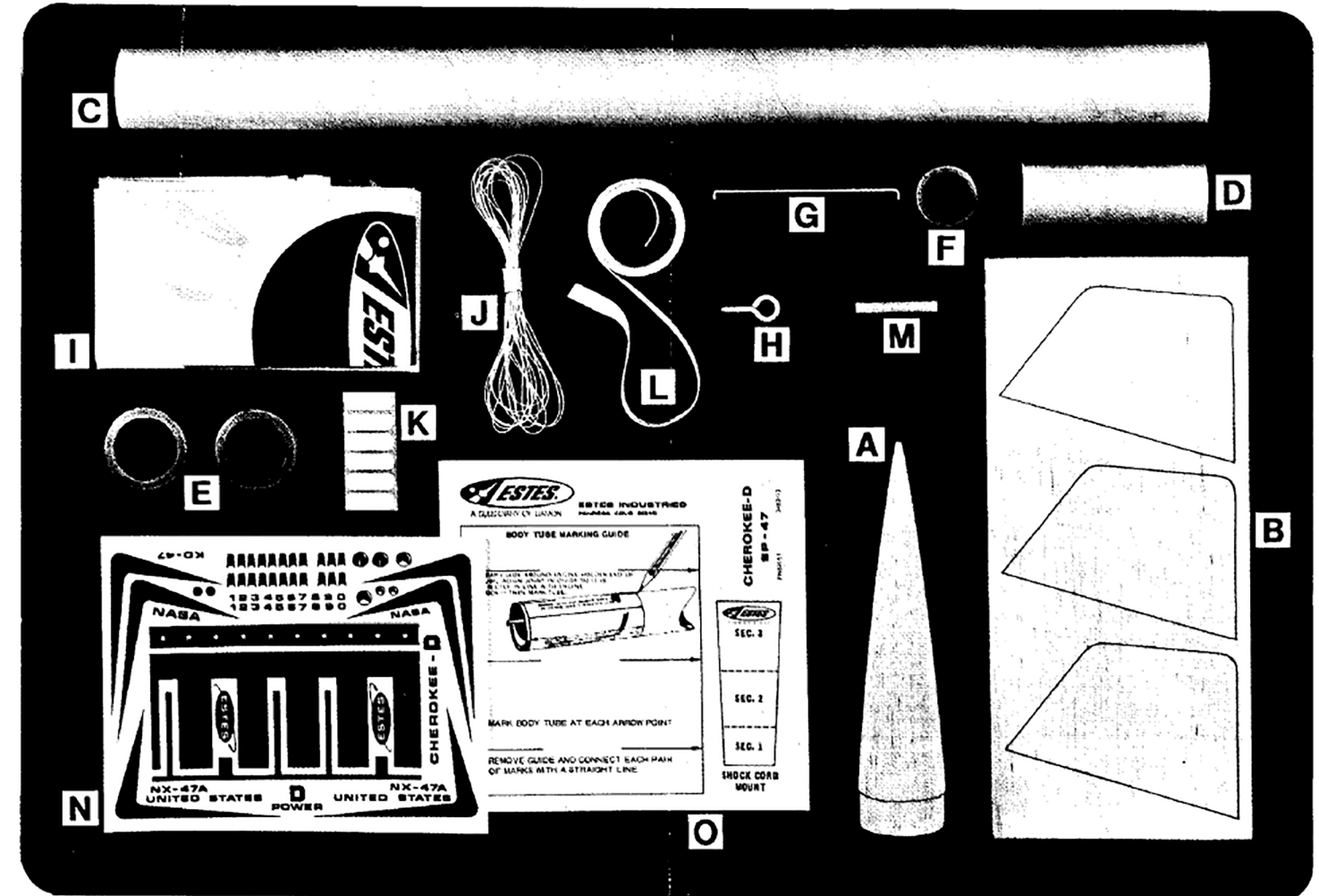

PARTS LIST

A	1	Nose Cone	Part #BNC-55AC
B	1	Die Cut Fin Set	#BF-47
C	1	Body Tube	#BT-55V
D	1	Body Tube	#BT-50J
E	2	Spacing Rings	#AR-5055
F	1	Spacing Ring	#AR-2050
G	1	Engine Holder	#EH-2
H	1	Screw Eye	#SE-2
I	1	18" Parachute	#PK-18A
J	1	108" Shroud Line	#SLT-108
K	6	Tape Strips	#TD-2F
L	1	1/4" Shock Cord	#SC-2
M	1	Launch Lug	#LL-2A
N	1	Decal Sheet	#KD-47
O	1	Pattern Sheet	#SP-47

RECOMMENDED ENGINES
D13-5, D13-7

WITH ADAPTER EM-2050
B6-4, C6-5

In addition to the materials included in your kit you will also need the following tools and materials:

- 1) Modeling knife or single edge razor blade
- 2) Scissors
- 3) Extra-strong white glue
- 4) Ball point pen or pencil
- 5) Fine and extra fine grit sandpaper
- 6) Paint or dope

NOTE: Never apply dope over spray enamels as it will ruin the finish.

Read the entire assembly instructions carefully before beginning work on your model rocket. Start construction, following each step, in order, checking off each step as it is completed.

ASSEMBLY INSTRUCTIONS

1 ENGINE MOUNT BASIC ASSEMBLY

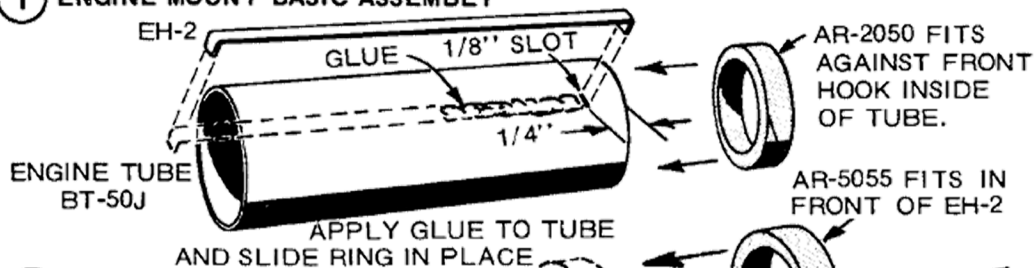

2 INSTALL SPACING RINGS

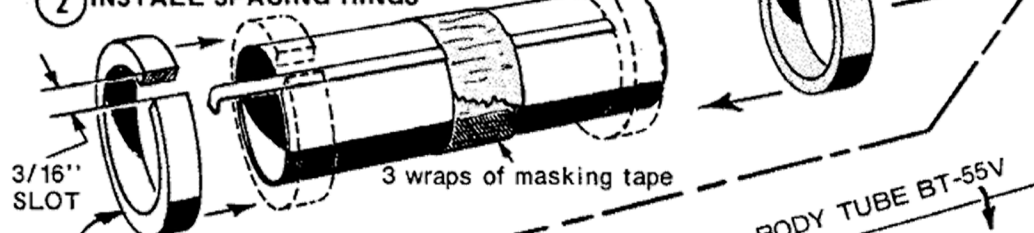

Fits with rear side even with rear edge of tube EH-2 is centered in the slot.

SPREAD GLUE 2 1/2" UP WITHIN THE TUBE

3 INSTALL MOUNT IN BODY TUBE

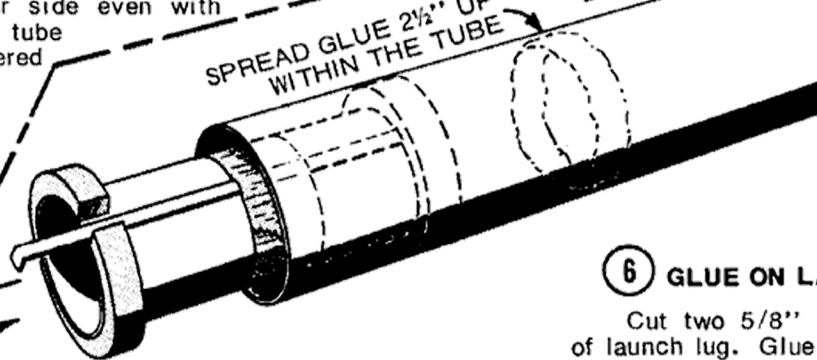

Insert engine mount into the body tube until the rear edge of the slotted ring rests 1/16" inside the end of the body tube. Apply a good fillet of glue around the ring/tube joint.

5 FIN ATTACHMENT

See the marking guide for setting fin guide lines relative to the engine hook.

NOTE:

Sight through the rear lug to be sure front lug is properly aligned on body.

Carefully remove the fin pieces from the stock.

Sand the leading, tip and trailing edges of each fin to a rounded shape. Sand flat the edges which are to glue to the body tube. Both sides of each fin are sanded smooth as a first preparation for step 9.

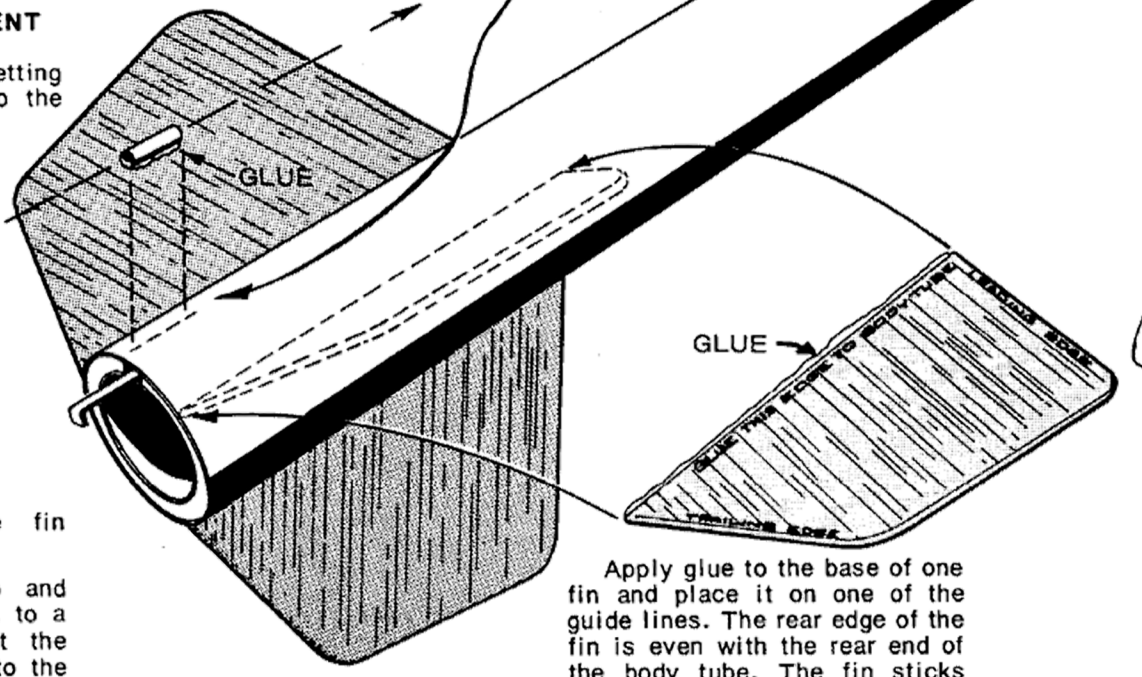

Apply glue to the base of one fin and place it on one of the guide lines. The rear edge of the fin is even with the rear end of the body tube. The fin sticks straight out from the body tube. Repeat this action with the other two fins.

4 SHOCK CORD AND MOUNTING

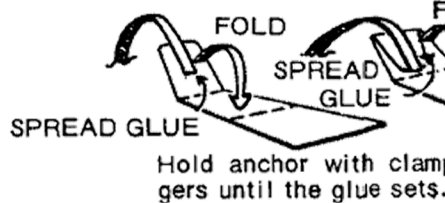

Spread a film of glue on the inside of the tube wall in the area shown. . .

After the unit has been in place and is dry, cut the lug at an angle as shown.

6 GLUE ON LAUNCH LUGS

Cut two 5/8" long pieces of launch lug. Glue them to the front and rear of body as shown.

Tie or

ins
eri
the

ASSEMBLY INSTRUCTIONS

1 ENGINE MOUNT BASIC ASSEMBLY

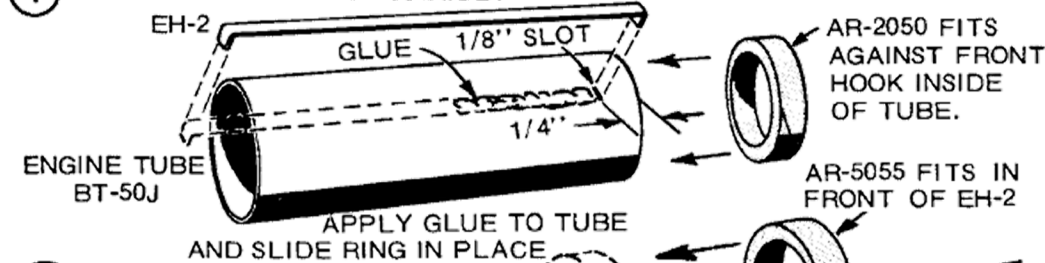

2 INSTALL SPACING RINGS

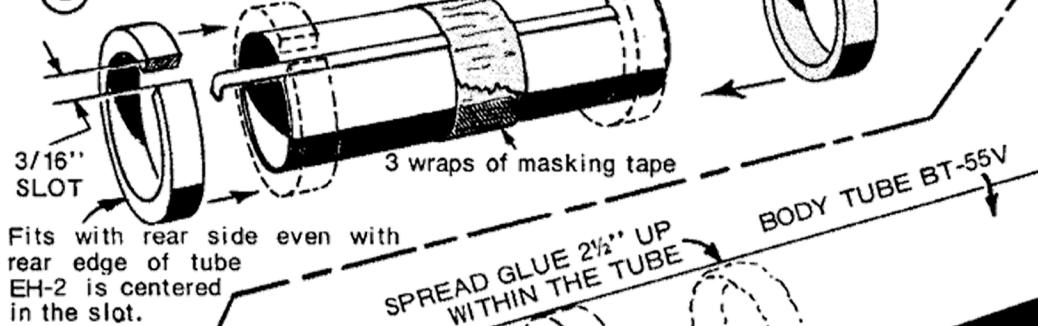

3 INSTALL MOUNT IN BODY TUBE

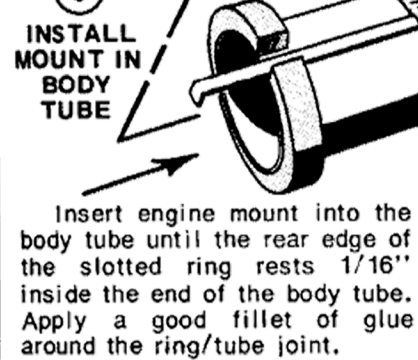

5 FIN ATTACHMENT

See the marking guide for setting fin guide lines relative to the engine hook.

NOTE:

Sight through the rear lug to be sure front lug is properly aligned on body.

Carefully remove the fin pieces from the stock.

Sand the leading, tip and trailing edges of each fin to a rounded shape. Sand flat the edges which are to glue to the body tube. Both sides of each fin are sanded smooth as a first preparation for step 9.

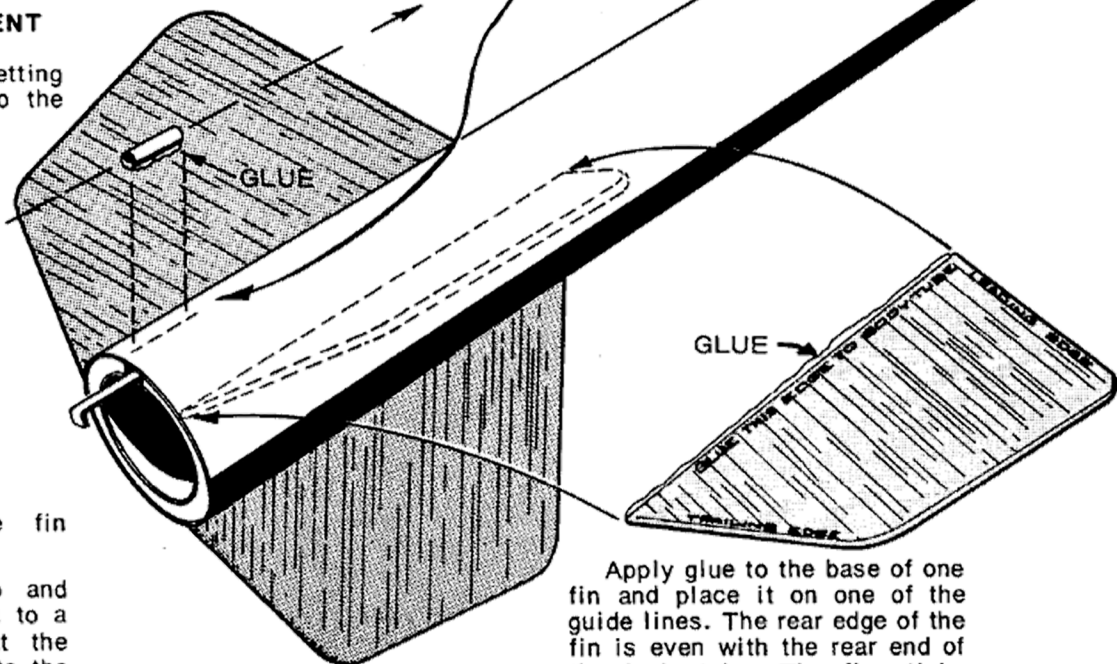

Apply glue to the base of one fin and place it on one of the guide lines. The rear edge of the fin is even with the rear end of the body tube. The fin sticks straight out from the body tube. Repeat this action with the other two fins.

4 SHOCK CORD AND MOUNT

Preassemble the shock cord and its anchor. (Anchor is clipped from Pattern sheet SP-47.)

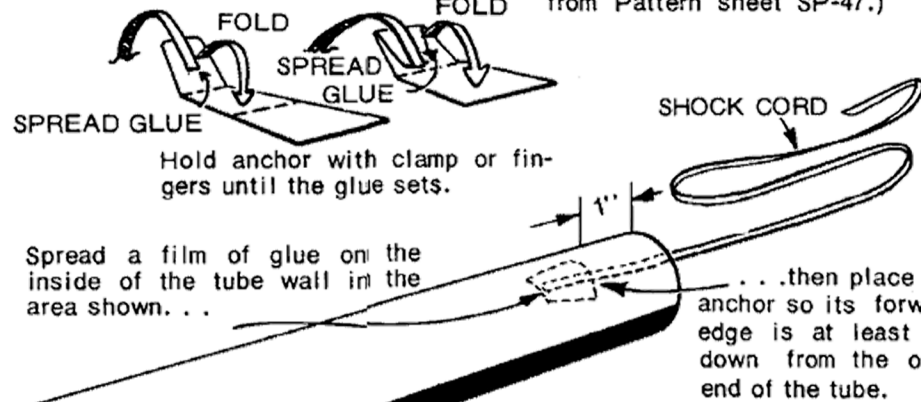

8 ATTACH RECOVERY PARTS

After the unit has been glued in place and is dry, cut front lug at an angle as shown.

Attach the screw eye to the base of the nose cone. Make a hole by inserting and removing the eye. Squirt glue into the hole and replace the eye.

Tie on the shock cord.

7 PARACHUTE

Assemble the parachute as instructed on the parachute material. Tie the shroud lines to the screw eye.

A FILLET IS...

A smooth joint - built up between body and fin by applying a line of glue along the joint, then smooth out the glue with a finger.

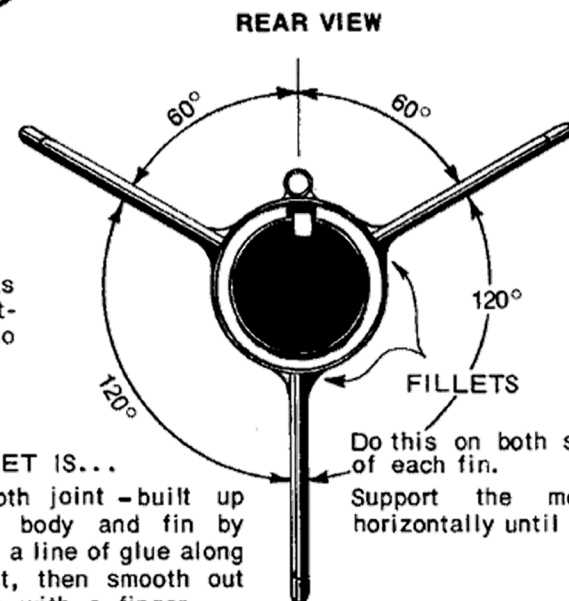

10 APPLY DECALS

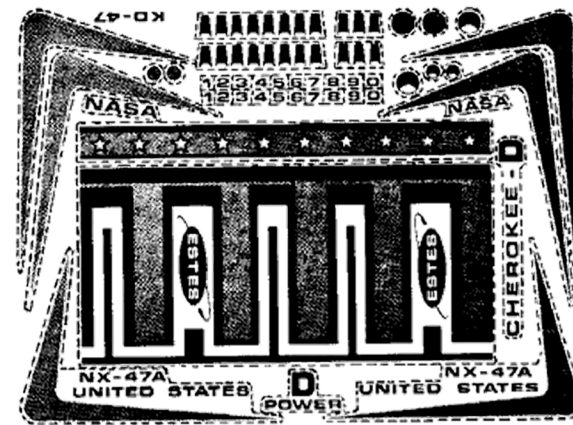

Dotted lines on the reproduction of this kit decal sheet (above) show the maximum area to allow around each individual decal when cutting them from the sheet.

Drawing to the right shows positions of each of the decals used on the original model.

9 PAINTING

Apply sanding sealer to the fins and the nose cone. Sand each until smooth to the touch. Repeat as necessary to fill all grain marks.

Paint work consists of a white base coat over everything, then a finish coat of white over the body tube and fins. The nose cone is painted a solid red.

Both roll pattern decals are designed to be used together, or to be separated as shown...

...in either case, the imaginary line (as sighted between front and rear lugs) is used to line the joint where the decal ends meet.

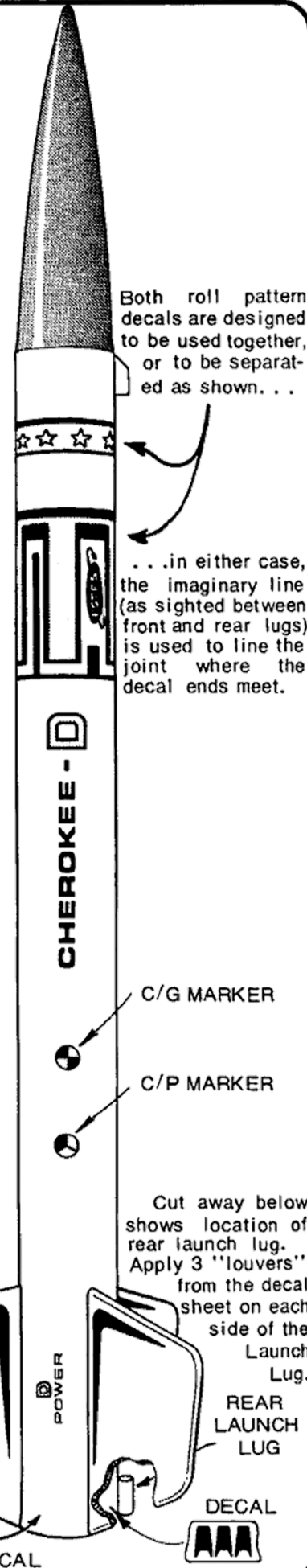

Cut away below shows location of rear launch lug. Apply 3 "louvers" from the decal sheet on each side of the Launch Lug.

10 APPLY DECALS

10 MOUNT Preassemble the shock cord and its anchor. (Anchor is clipped from Pattern sheet SP-47.)

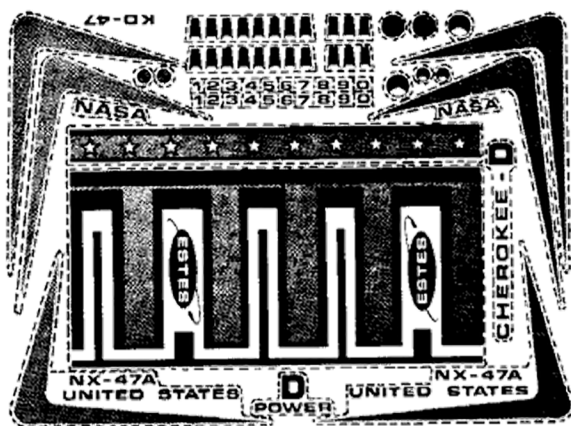
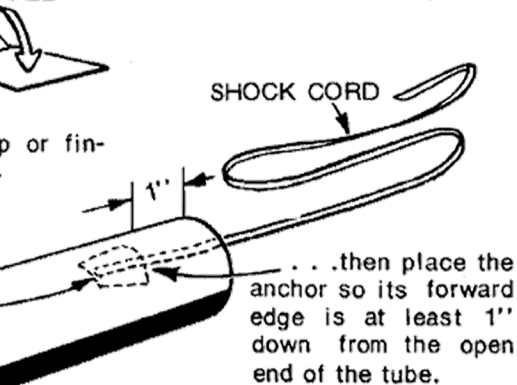

Dotted lines on the reproduction of this kit decal sheet (above) show the maximum area to allow around each individual decal when cutting them from the sheet.

Drawing to the right shows positions of each of the decals used on the original model.

8 ATTACH RECOVERY PARTS

Attach the screw eye to the base of the nose cone. Make a hole by inserting and removing the eye. Squirt glue into the hole and replace the eye.

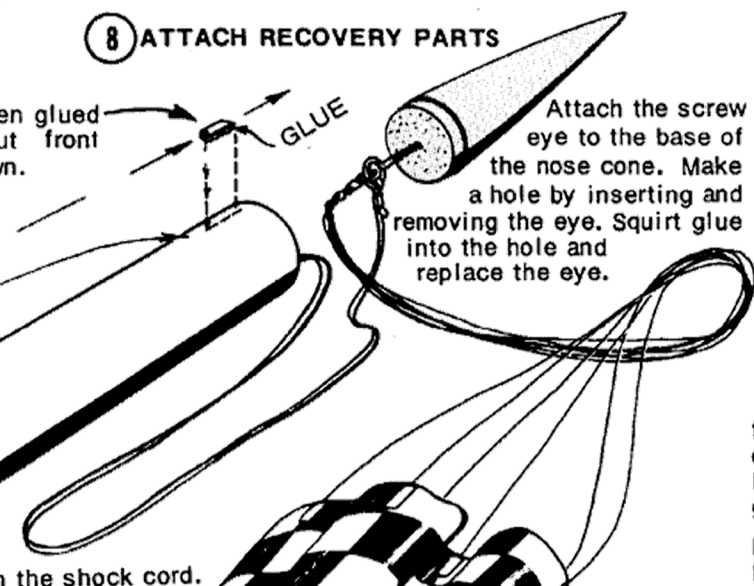

7 PARACHUTE

Assemble the parachute as constructed on the parachute material. Tie the shroud lines to a screw eye.

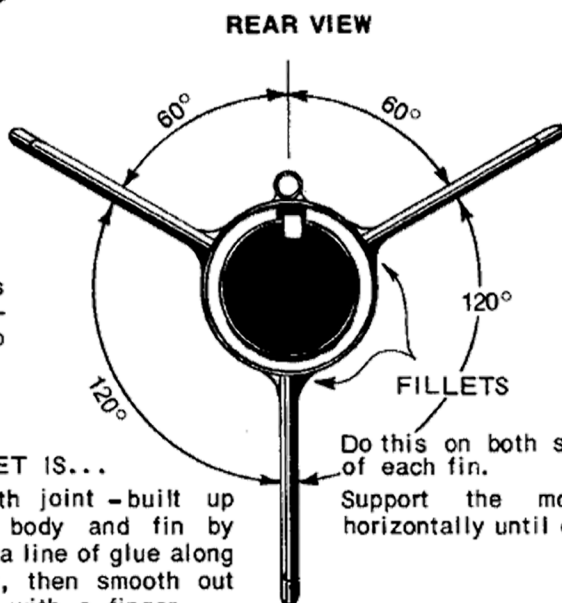

A FILLET IS...

A smooth joint - built up between body and fin by applying a line of glue along the joint, then smooth out the glue with a finger.

9 PAINTING

Apply sanding sealer to the fins and the nose cone. Sand each until smooth to the touch. Repeat as necessary to fill all grain marks.

Paint work consists of a white base coat over everything, then a finish coat of white over the body tube and fins. The nose cone is painted a solid red.

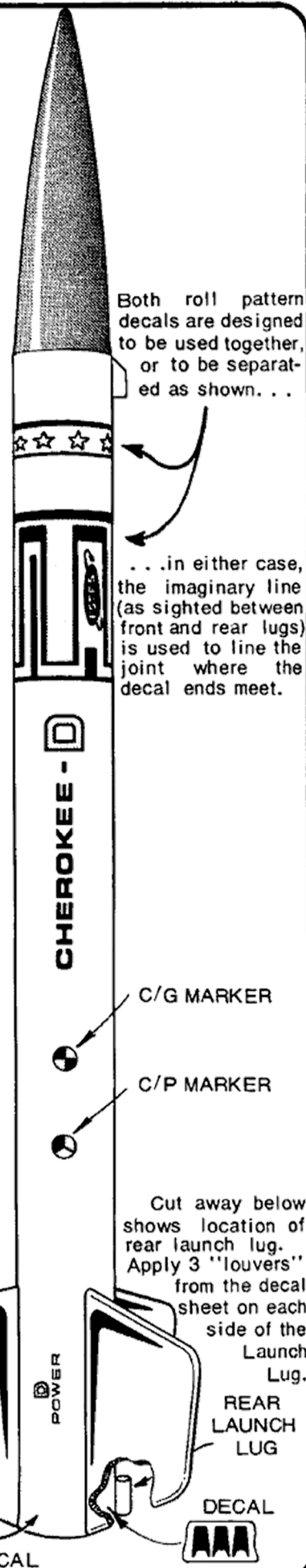

Cut away below shows location of rear launch lug. Apply 3 "louvers" from the decal sheet on each side of the Launch Lug.

REAR LAUNCH LUG

DECAL

DECAL

300
DPI

300 DPI

Na.C303SR

THE U.S. ST
ATHOL.M.

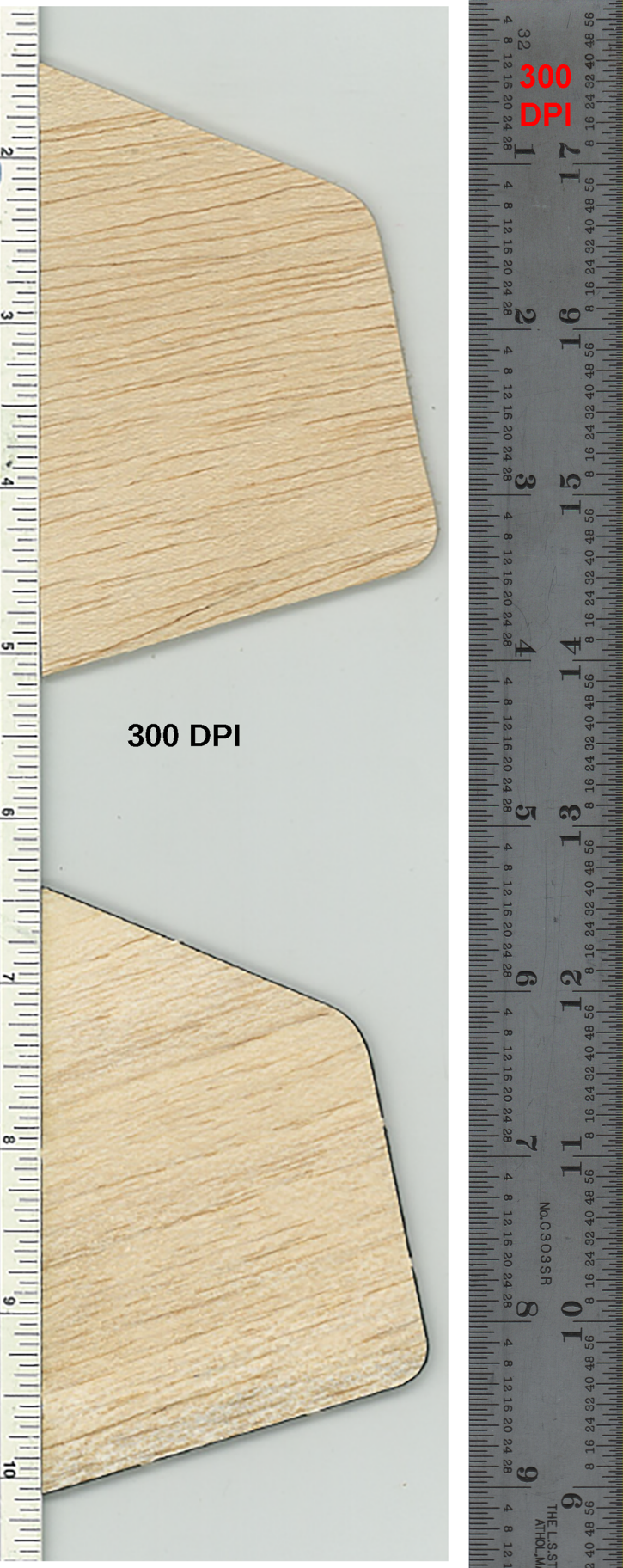

February

Original, Damon Era,
Estes Cherokee-D (K-47 #1247)
Die-Cut Balsa Sheet Type BF-47
Part No. 32220
.0935" Thick Balsa



Rule Maui

June

July

Original, Estes Magician (2440)
Laser Cut Main Fins
Part Number 032234
.102 Thick Balsa



October to November

October

November





A SUBSIDIARY OF DAMON

ESTES INDUSTRIES
BOX 227, PENROSE, COLO. 81240

BODY TUBE MARKING GUIDE

WRAP GUIDE AROUND ENGINE HOLDER END OF TUBE. ALIGN JOINT IN GUIDE SO IT IS DIRECTLY IN LINE WITH ENGINE HOOK — THEN MARK TUBE.

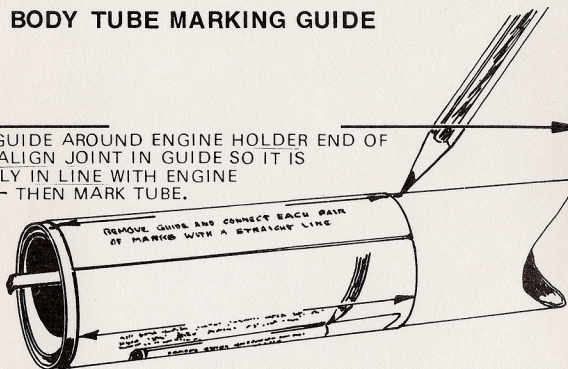

MARK BODY TUBE AT EACH ARROW POINT

REMOVE GUIDE AND CONNECT EACH PAIR OF MARKS WITH A STRAIGHT LINE

CHEROKEE-D

SP - 47

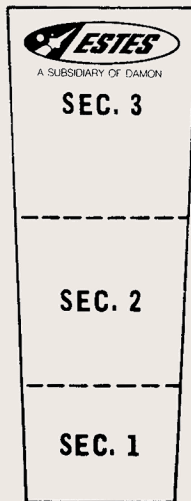

SHOCK CORD MOUNT



300
DPI

No.CC903SR



Whales Rule Maui Waters - Dec



300
DPI

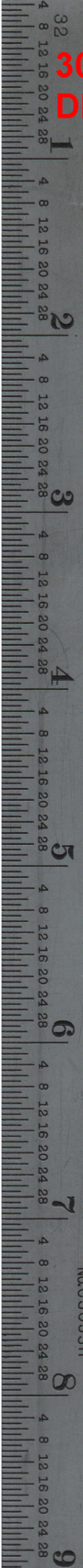

No.CC903SR

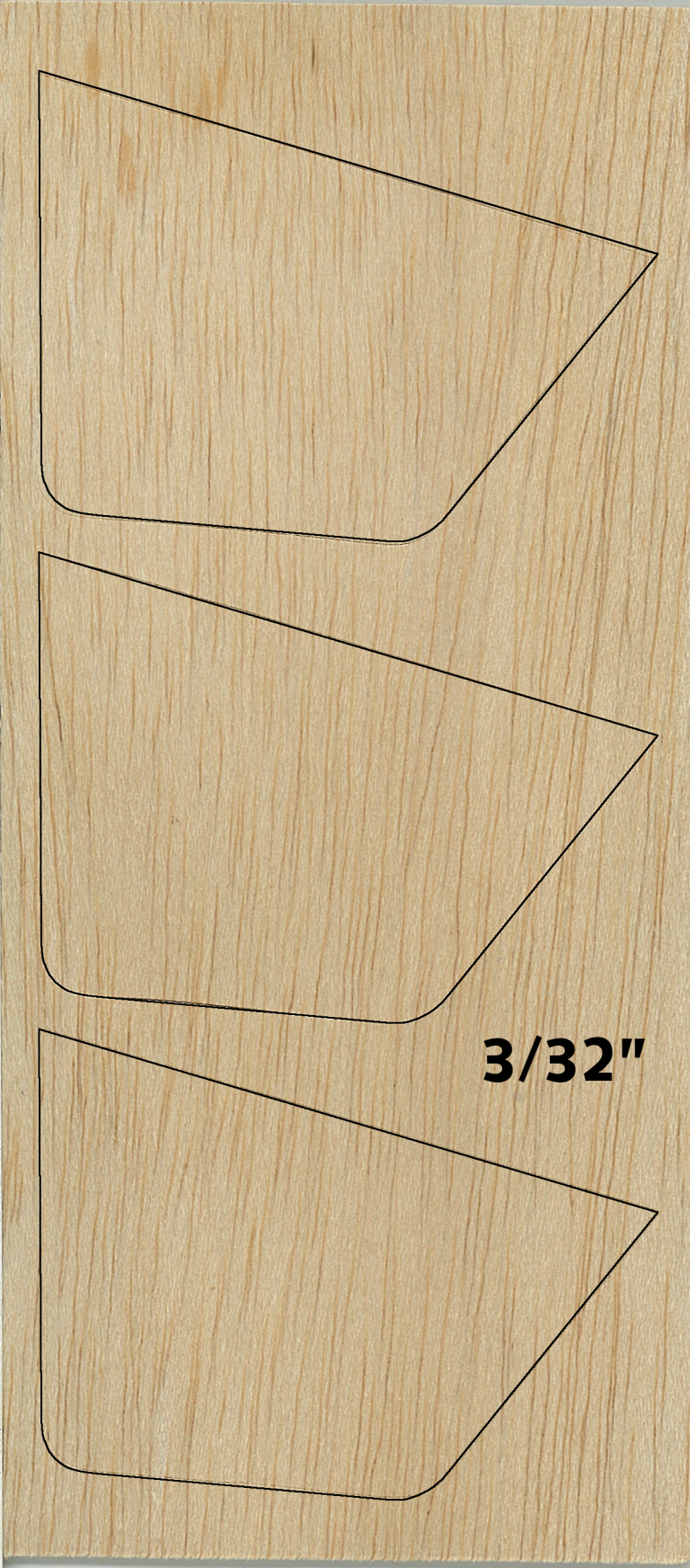

3/32"

Whales Rule Maui Waters - Dec



January

February

March

April

May

June

July

August

September

cm 1 2 3 4 5 6 7 8 9 10 11 12 13 14 15 16 17 18 19 20 21 22 23

300
DPI

1 2 3 4 5 6
4 8 12 16 20 24 28

7 8 9 10 11 12 13 14 15
4 8 12 16 20 24 28

5970LT NR

AAAAAAAAAA
AAAAAAAAAA
1234567890
1234567890



NASA

NASA



CHEROKEE - 

NX-47A
UNITED STATES

 POWER

UNITED STATES
NX-47A

INCHES 1 2 3 4 5 6

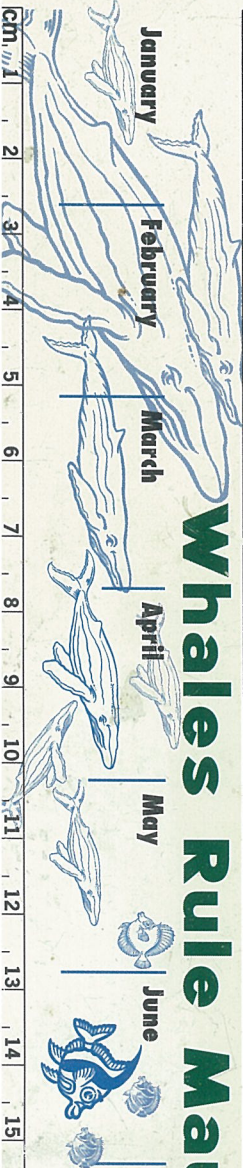

January

February

March

April

May

June

Whales Rule Maui

Estes K-47/1247 Cherokee-D notes

This kit has gone through many changes over the years. Current as of this writing, the Cherokee-E #2408, available at Hobby Lobby, is the same as the later version of the Cherokee-D with an upgraded motor mount to allow it to use the longer 24mm 'E' motors and a longer airframe.

There are 3 versions of this kit included in this post. The Pre-Damon "Astron", the early "Damon", and the later "Damon". I believe there was a version prior to the "Astron" version posted here due to the fact that it came with a cardstock pattern for the fins. This would indicate the builder was to cut the fins out from blank balsa stock yet the version I have also includes a die-cut fin sheet. If anyone has the earlier version please consider sending scans to update this posting.

- Nose cone
 - All versions prior to the later Damon used the balsa BNC-55AC, the later version changed to the plastic PNC-55AC, (71070).
- Body tube
 - All versions prior to the later Damon used the 16.35" long BT-55V, the later version changed to the 18" long BT-55. The stock photo was never updated so they all show the short version.
- Fins
 - The Astron version had 2 piece fins and were die-cut on 3" wide balsa stock. All Damon versions were die-cut on 4" wide balsa stock. All were 3/32" thick. The die has a small error where one of the fins, center, appears to have a slight concave at the tip. This is not consistent with the other 2 fins. This can be clearly seen on the scan with the outline overlay.
- Recovery system
 - All versions call out the PK-18A. As seen in the parts layouts, the Astron checkerboard switched over to the Damon logo parachute even though the early Damon package found on line shows the Astron chute in the Damon package.
- Decals
 - The pre-Damon version has the Astron orbit logo and the later Damon version have the Damon logo. The Damon version replaced the KD-47 with part number 37045.
- Other
 - All balsa nose cone versions came with a screw eye that is absent on the plastic nose cone versions.
 - The pre-Damon version came with a snap swivel missing on all later versions.
 - The pre-Damon version came with a wood dowel lug standoff missing on all later versions.
 - The pre-Damon and early-Damon versions used tape for the hook retainer; the later Damon version came with a hold down strap on the pattern sheet.
 - The early-Damon parts layout shows the pre-Damon decal yet it came with the Damon logo decal.
 - The early-Damon packaging still had the Astron orbit logo on the face card but had the Damon logo on the hang tag.

PARTS LIST KIT NO. k-47 - Cherokee-D (Early Damon)

Quantity	Description	Type	Number	Detail1	Detail2	Detail3	Detail4	Comment
	BALSA NOSE CONE	BNC-55AC	70274	5.375" long	1.325" dia.	.375" shoulder		
	Die Cut Fin Set	*BF-47	N/A	4" wide	9" long	3/32" thick		Scan
	PAPER BODY TUBE	BT-55V	30392	16.35" long	1.283" ID	1.325" OD	0.021" wall	Glassine
	PAPER BODY TUBE	BT-50J	30362	2.75" long	0.950" ID	0.976" OD	0.013" wall	Glassine
	CENTERING RINGS	AR-5055	30166	.977" ID	1.27" OD	0.25" long	BT-50 in BT-55	Set of 2
	CENTERING RINGS	AR-2050	30164	0.25" long	0.737" ID	0.949" OD	0.106" wall	Green
	ENGINE HOLDER	EH-2	35025	2.8" long	.100" wide	.025" thick		Reg. & D
	Screw Eye (Large)	SE-1	38251	1" long				
	Parachute	PK-18A	35802	18" dia.	18" x 6 Shrouds	LDPE plastic	Red/Yel	Astron Logo
	Shroud Line	SLT-108	38239	108"	.020" diameter	Twisted cotton		For 18" to 24"
	Tape Strip	TD-2F	2297	1/4" wide	3/4" long	Paper	Self-Stick	6x
	Shock Cord	SC-2	85736	18" long	1/4" wide			Rubber
	LAUNCH LUG	LL-2A	38175	5/32" ID	1/8" rod	1.25" long		Mylar
	Decal Sheet	KD-47	37045	4.5" wide	6" long	Red/Blk	Waterslide	Scan
	Pattern Sheet	SP-47	N/A	5.5" wide	5.5" long	Cardstock		Scan
*	BALSA FIN STOCK	BFS-30(4x9)	N/A	4" wide	9" long	3/32" thick	0.09375	

ESTES
MODEL ROCKETRY
SCIENTIFIC RESEARCH SOCIETY

ESTES
Astron
CHEROKEE-D

"D"
ENGINE POWER



DIE CUT FINS
COLORFUL DECAL

\$2.75

Design by Gene Street

CHEROKEE-D

KIT NO. K-47 \$2.75

SPECIFICATIONS	RECOMMENDED ENGINES
Length: 16.6 in.	D13-3 D13-7
Body Dia: 1.325 in.	
Weight: 2.75 oz.	WITH ADAPTER CW-2050
Fin Span: 6 in.	B6-4 C6-5

PARACHUTE RECOVERY

