

Flies Over and Over  
To **1744** feet (532 meters)

SKILL  
LEVEL

**1**

FOR THE BEGINNING MODELER

# space racer™



Length: 12.625 in. (32.1 cm)

Dia.: .736 in. (18.7 mm) Weight: 73 oz. (20.8 g)

Recommended Engines: 1/2A6-2 (First Flight), A8-3,

A8-5, B4-4, B4-6, B6-4, B6-6, B6-5, C5-3, C6-3, C6-5, or C6-7

**WINNER OF THE INTERPLANETARY  
GOVERNOR'S CUP**

**#2039**



0 47776 02039 9

# SPACE RACER™

FLYING MODEL ROCKET #2039



ESTES INDUSTRIES  
1295 H Street  
Penrose, CO 81240

SPACE RACER

Governor's Cup... Citizen's Class

## ASSEMBLY TIPS

Read all instructions before beginning work on your model. Make sure you have all parts and supplies. Test-fit all parts together before applying any glue. If any parts don't fit properly, sand as required for precision assembly.

## PARTS AND SUPPLIES

Locate the parts shown below and lay them out on the table in front of you.

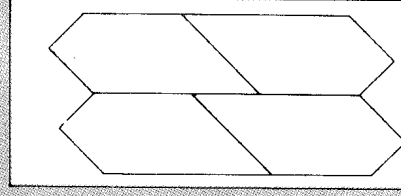
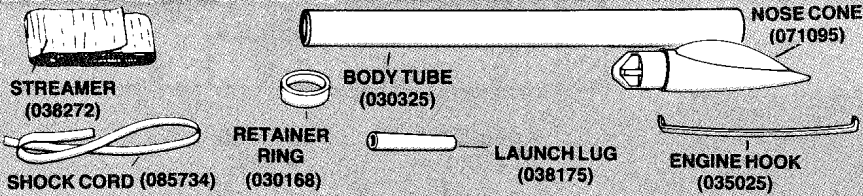

In addition to the parts included in the kit, you will also need:



## ROCKET ASSEMBLY

### 1.

- Cut out tube marking guide from top of page 2 and save for step 5. Wrap guide around tube 1/8" (3 mm) from one end. Apply tape. Mark tube at arrows. Remove guide.
- Draw straight lines connecting each pair of marks. Extend engine hook line 4" (102 mm).

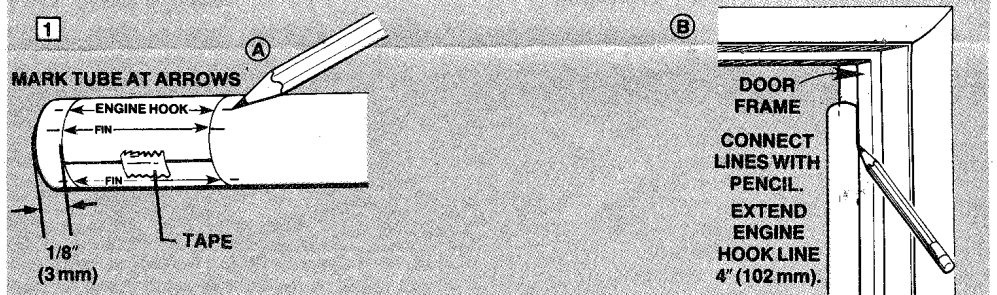

### 2.

- Cut 1/8" (3 mm) wide engine hook slit 2 1/2" (64 mm) from end of tube on engine hook line.

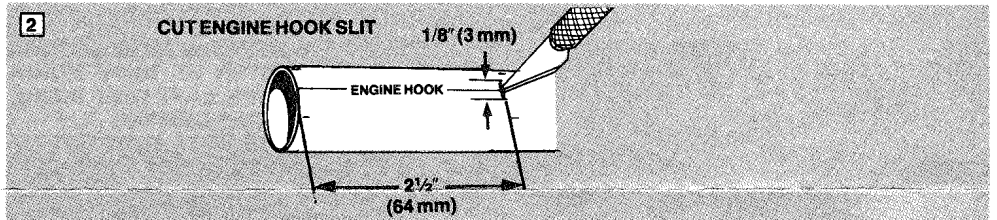

### 3.

- Remove fins from die-cut sheet.
- Put SMALL line of glue along fin root edge.
- Place fin on body tube line.
- Remove fin and allow about 15 seconds for glue to become tacky.
- Add a bit more glue, place fin back on tube line. Repeat for remaining three fins. Allow glue to dry completely.

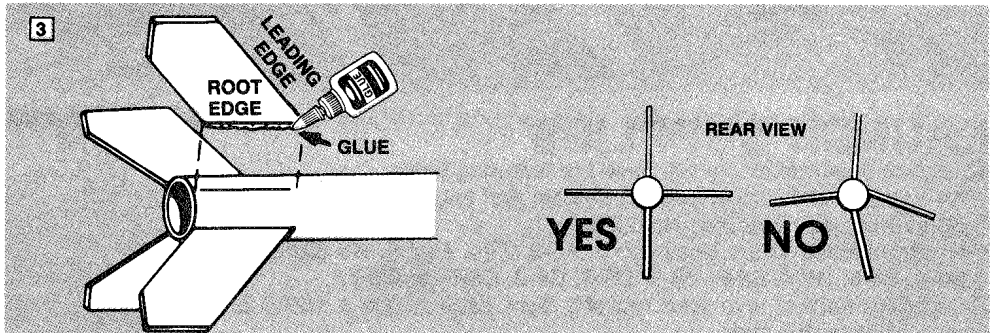

### 4.

- Apply bead of glue around tube 3/8" (10 mm) in front of fins.
- Push one end of engine hook into slit and lay hook straight along tube.
- Slide retainer ring over engine hook and down to edge of fins.
- ADD GLUE REINFORCEMENT TO ENGINE HOOK AS SHOWN.
- Glue launch lug beside engine hook with rear against retainer ring. Let glue dry completely.
- Apply a reinforcement of glue on each side of fins and launch lug. Let glue dry completely.

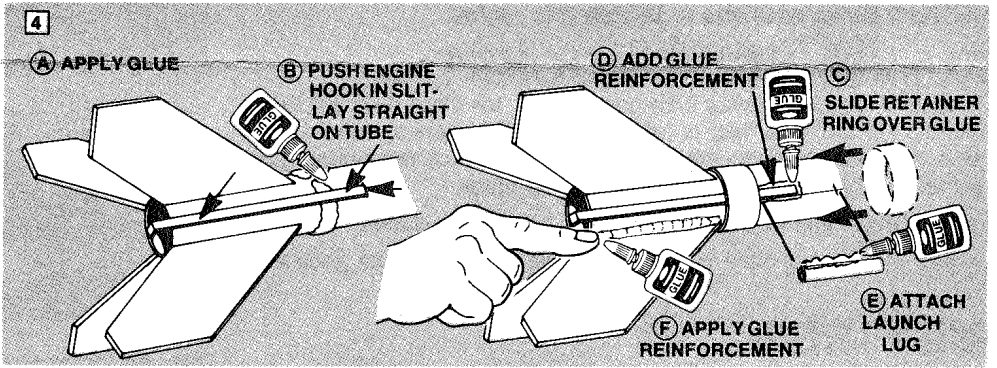

### 5.

- Cut shock cord mount from tube marking guide.
- Crease on dotted lines by folding. Spread glue on section 2 and lay end of shock cord into glue at a slight diagonal as shown. Fold section 1 forward. Apply glue to section 3. Fold forward again. Clamp firmly with your fingers until glue sets.
- Apply glue to the shock cord mount. With the shock cord mount positioned on the end of your finger or a pencil, gently position the mount into the front of the body tube. Set back far enough from the front edge of the tube to allow the nose cone to fit into place (1 1/2" - 38 mm). Press shock cord mount into position. Smear a film of glue over the mount and surrounding area in the body tube to insure a good bond and a smooth surface.

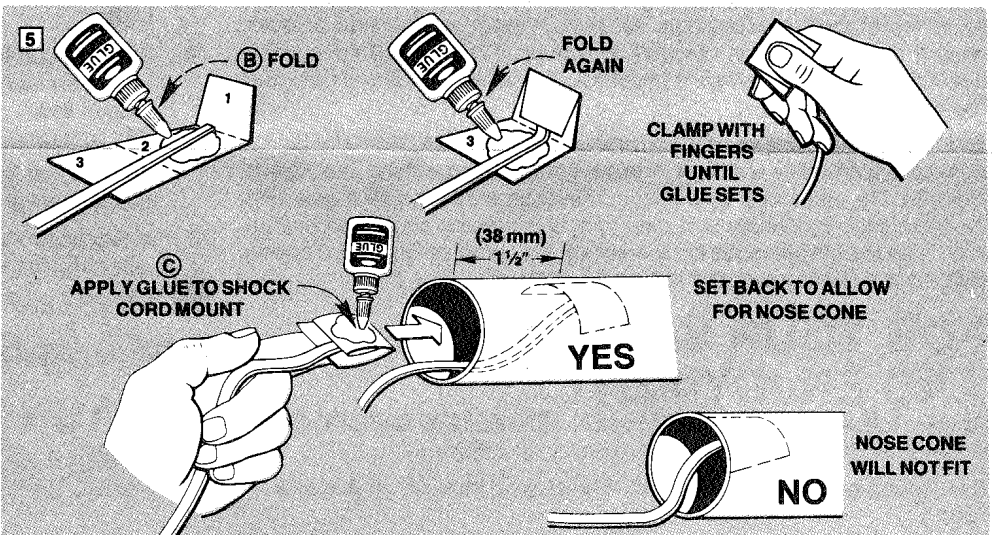



6.

Trim excess plastic from around sides of nose cone with a sharp knife. Also remove any excess plastic from inside molded eyelet. Wipe nose cone with damp cloth to remove oil and dirt.

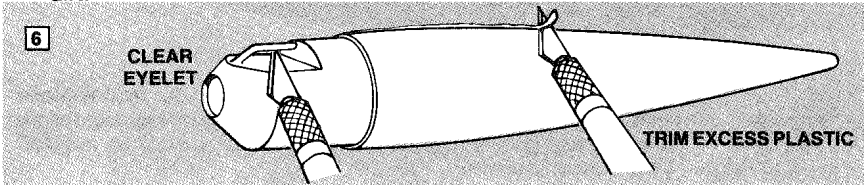

7.

- A. Tie shock cord to streamer.
- B. Tie shock cord to nose cone with double knot.

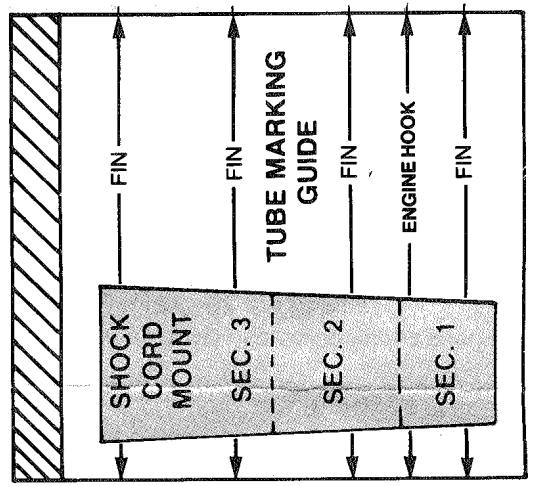
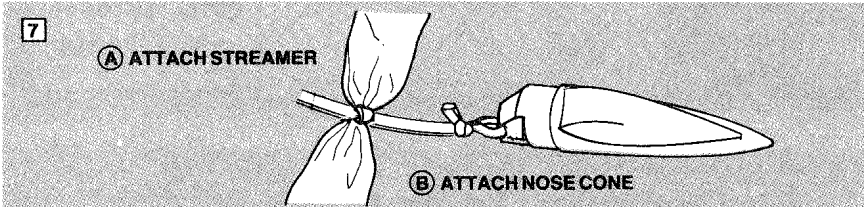

CUT OUT FOR STEP 1.

SAVE FOR STEP 5.

## FINISHING YOUR ROCKET

When completely dry, paint entire model with gloss Scarlet Red enamel spray paint. Allow paint to dry overnight.

To apply decals, cut each from decal sheet, dip in lukewarm water for

about 30 seconds, and hold until it uncurls. Refer to front of panel for decal placement. Slip decal off backing sheet onto model. Blot away excess water. For best results, let decals dry overnight and apply a coat of clear gloss spray to protect decals.

## ROCKET PREFLIGHT

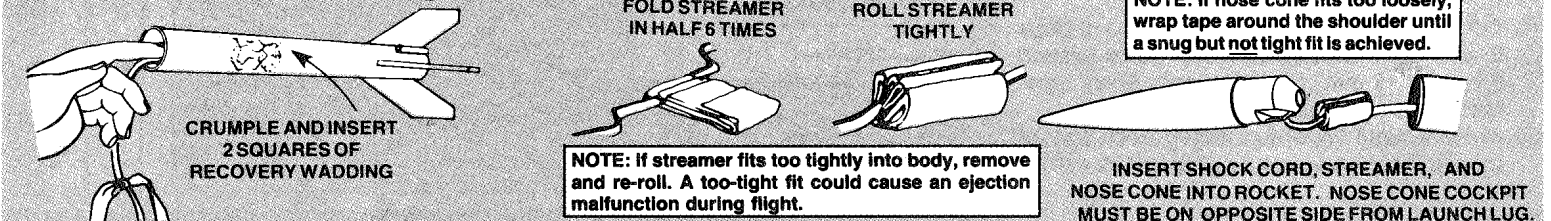

## PREPARE ENGINE

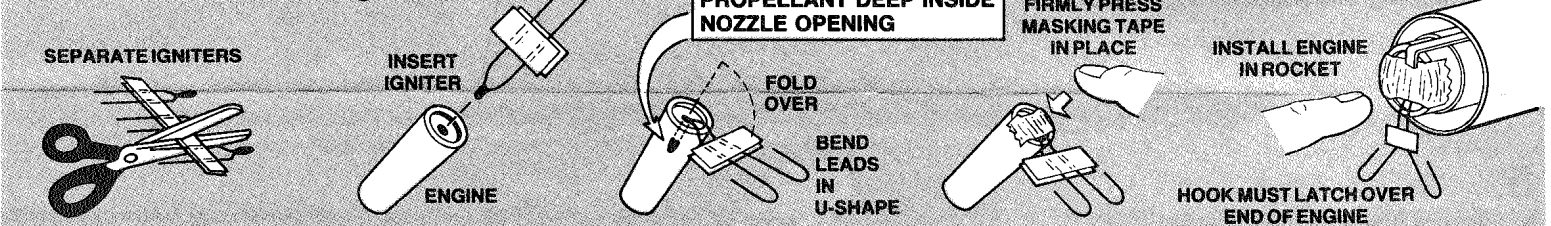

## LAUNCH SUPPLIES

To launch your rocket you will need the following items:  
 —An Estes Model Rocket Launch System and Launch Pad  
 —Estes Recovery Wadding No. 2274  
 —Recommended Estes Engines: 1/2A6-2 (First Flight), A8-3, A8-5, B4-4, B4-6, B6-4, B6-6, B8-5, C5-3, C6-3, C6-5, or C6-7.  
 To become familiar with your rocket's flight pattern, use a 1/2A6-2 engine for your first flight.  
**Use only Estes products to launch this rocket.**

## FLYING YOUR ROCKET

Choose a large field away from power lines, tall trees, and low flying aircraft. Try to find a field at least 250 feet (76 meters) square. The larger the launch area, the better your chance of recovering your rocket. Football fields and playgrounds are great.

Launch area must be free of dry weeds and brown grass.  
 Launch only during calm weather with little or no wind and good visibility.

## MISFIRES

Failure of the model rocket engine to ignite is nearly always caused by incorrect igniter installation. An Estes igniter will function properly even if the coated tip is chipped. However, if the coated tip is not in direct contact with the engine propellant, it will only heat and not ignite the engine.

When an ignition failure occurs, remove the safety key from the launch control system and wait one minute before approaching the rocket. Remove the expended igniter from the engine and install a new one. Be certain the coated tip is in direct contact with the engine propellant, then tape the igniter leads firmly to base of engine as illustrated above. Repeat the countdown and launch procedure.

## FOR YOUR SAFETY AND ENJOYMENT

Always follow the NAR-HIA\* MODEL ROCKETRY SAFETY CODE while participating in any model rocketry activities.

\*National Association of Rocketry-The Hobby Industry of America  
 Page 2

## COUNTDOWN AND LAUNCH

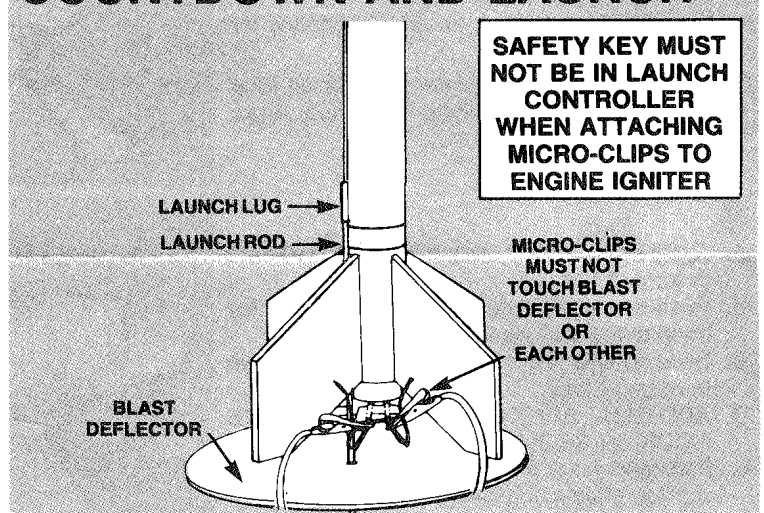

- ⑩ BE CERTAIN SAFETY KEY IS NOT IN LAUNCH CONTROLLER.
- ⑨ Remove safety cap and slide launch lug over launch rod to place rocket on launch pad. Make sure the rocket slides freely on the launch rod.
- ⑧ Attach micro-clips to the igniter wires. Arrange the clips so they do not touch each other or the metal blast deflector. Attach clips as close to protective tape on igniter as possible.
- ⑦ Move back from your rocket as far as launch wire will permit (at least 15 feet - 5 meters).
- ⑥ INSERT SAFETY KEY to arm the launch controller.

Give audible countdown 5...4...3...2...1

**LAUNCH!!** PUSH AND HOLD LAUNCH BUTTON UNTIL ENGINE IGNITES

REMOVE SAFETY KEY FROM LAUNCH CONTROLLER. REPLACE SAFETY KEY AND SAFETY CAP ON LAUNCH ROD.

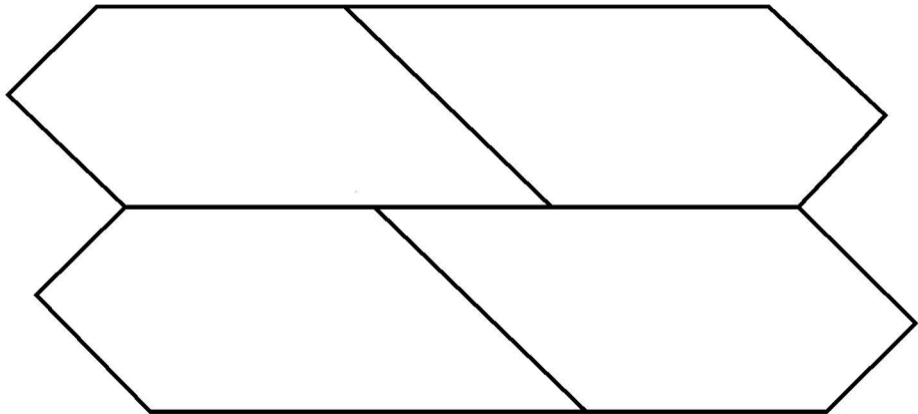

**.048" Fiber Stock**

32  
ESTES



ESTES PN  
037479



*SPACE RACER™*

Governor's Cup..... Citizen's Class



INCHES

1

2

3

BNR-12