



FLYING MODEL

ROCKET

EXPLORER™ SERIES

SKILL LEVEL 2

TM
Silver Comet



●
1950'S
SCIENCE
FICTION
STYLING!

●
ROCKETS
TO
NEARLY
500 FEET
(150 m)!

●
FEATURES
PLASTIC
TAIL CONE,
AND
THROUGH-
THE-WALL
FINS!





ESTES INDUSTRIES
1295 H Street
Penrose, CO 81240

EXPLORER™
SERIES
SKILL LEVEL 2

(7-96) 82127

EST 2141

SILVER COMET™

FLYING MODEL ROCKET KIT INSTRUCTIONS

TOOLS REQUIRED: HOBBY KNIFE, WHITE OR YELLOW GLUE, RAZOR SAW, SANDPAPER, SHARP PENCIL, TUBE-TYPE PLASTIC CEMENT, AUTOMOTIVE SPRAY PRIMER, AND BRIGHT SILVER SPRAY PAINT.

ALL GLUED AREAS ARE SHADED IN GRAY

PARTS LAYOUT

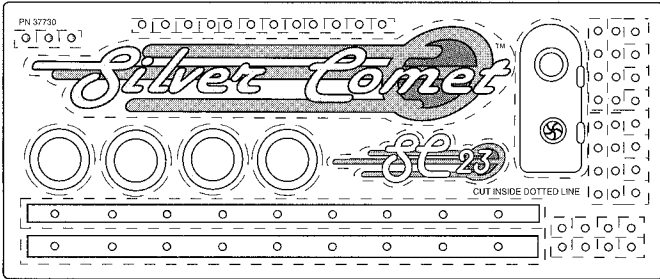

DECAL SHEET (1)
(37730)

NOSE CONE #80SC (1)
(72664)

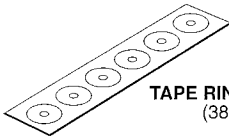

TAPE RING SET (1)
(38407)



LAUNCH LUG #12 (1)
(38166)



SHOCK CORD 1/4 X 24 (1)
(38383)

BODY TUBE #80T (1)
(30435)



ENGINE HOLDER RING #50 (1)
(30160)

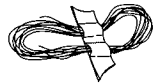

SHROUD LINE #108 (1)
(38239)

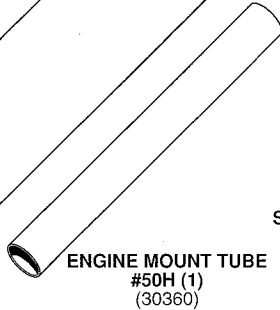

ENGINE MOUNT TUBE #50H (1)
(30360)

TAIL CONE #80 (1)
(71033)

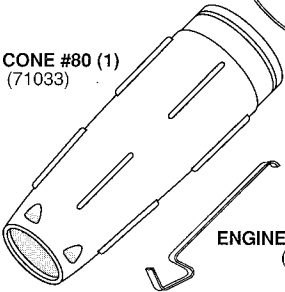

ENGINE HOOK #2A (1)
(35021)



PARACHUTE #18 (1)
(35821)

DIE CUT CARD (1)
(32434)

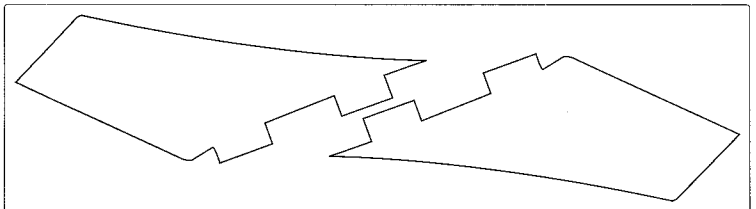
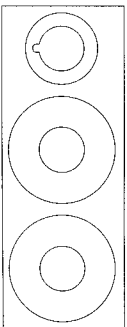

DIE CUT BALSA FIN SHEETS (2) (32257)

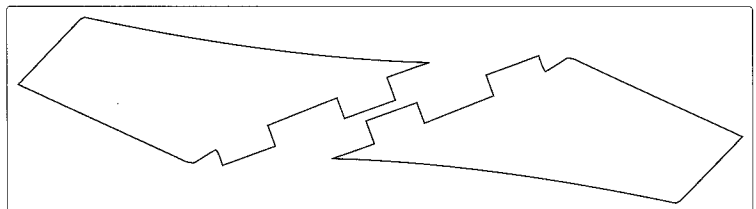

1. ✓

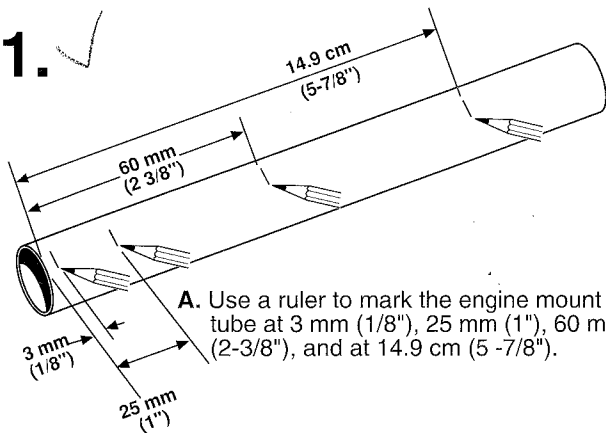

A. Use a ruler to mark the engine mount tube at 3 mm (1/8"), 25 mm (1"), 60 mm (2-3/8"), and at 14.9 cm (5-7/8").

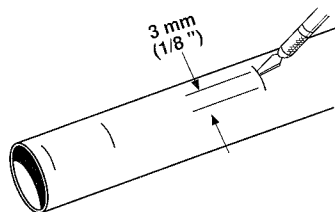

B. Use a hobby knife to make a 3 mm (1/8") wide slit at the 60 mm (2-3/8") mark **only**.

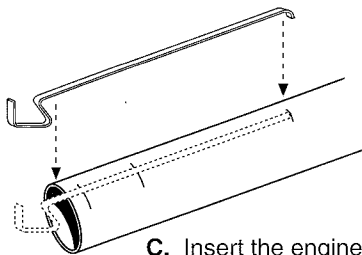

C. Insert the engine hook into slit as shown.

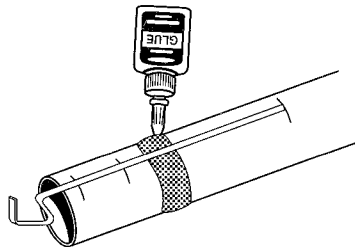

D. Apply a band of glue just above the 25 mm (1") mark.

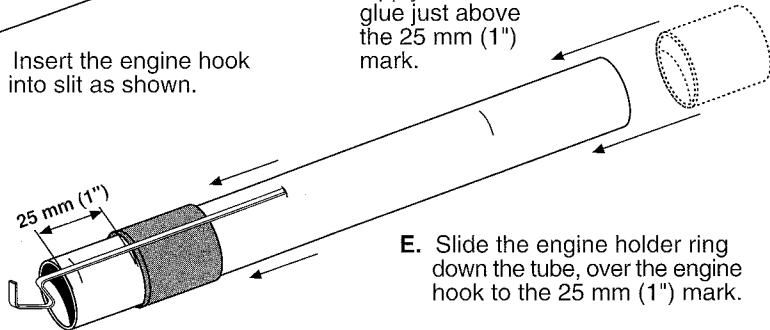

E. Slide the engine holder ring down the tube, over the engine hook to the 25 mm (1") mark.

2.

- A. Use a hobby knife to carefully remove the die cut centering rings from their card.

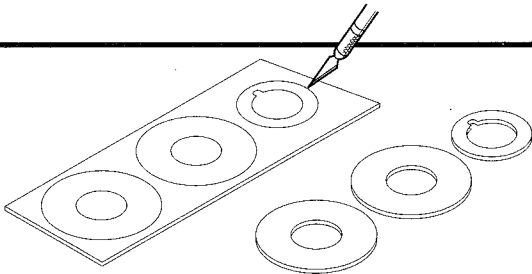

- B. Slide one large centering ring to the 14.9 cm (5-7/8") mark on engine mount tube.

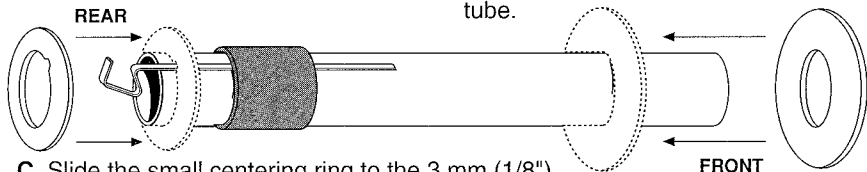

- C. Slide the small centering ring to the 3 mm (1/8") mark on engine mount tube with notch over engine hook.

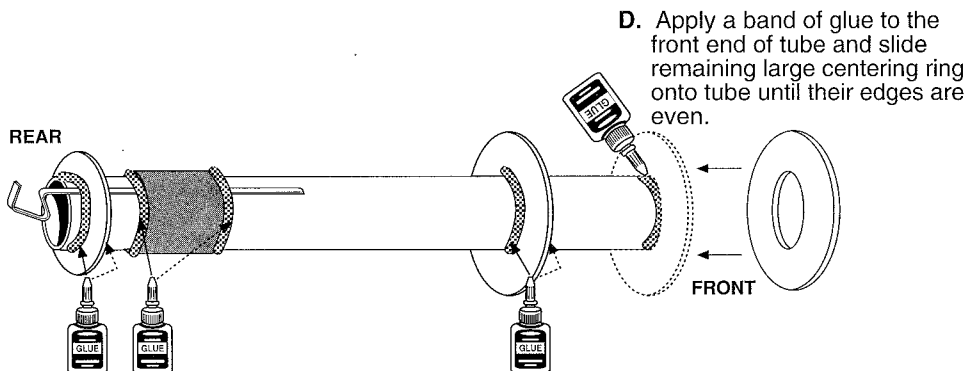

- D. Apply a band of glue to the front end of tube and slide remaining large centering ring onto tube until their edges are even.

- E. Bead glue around both sides of the small centering ring, the engine holder ring, and the large centering ring at the 14.9 cm (5-7/8") mark. Set assembly aside to dry.

3.

A. Use a modeler's razor saw to carefully remove plastic nibs on tail cone to allow for fin insertion.

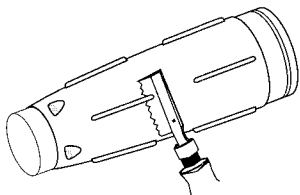

B. Gently sand remaining excess plastic with a sanding block so that fin slots are smooth and flush with surface of tail cone.

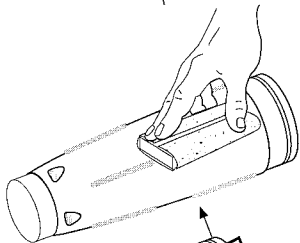

C. Again use your razor saw to remove the excess plastic ends from the tail cone by making repeated light cuts around the grooves.

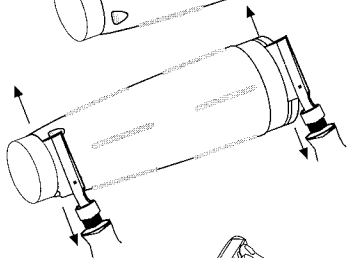

D. Gently sand the excess plastic from the front and rear of the tail cone (Work slowly to avoid tearing the plastic).

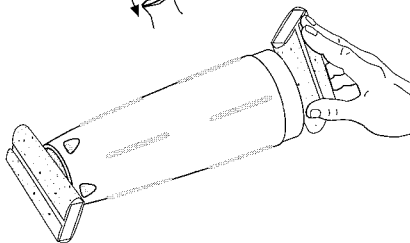

4.

A. Use a hobby knife to carefully cut fins out of balsa sheet. Be sure that cuts go completely through the balsa. (As you cut each fin, cut away from adjacent fins so you won't damage them.) Carefully remove fins from sheet.

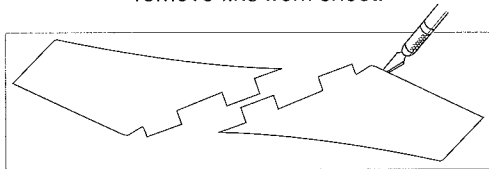

B. Keep a long stick of balsa wood from sheet to use as a glue applicator.

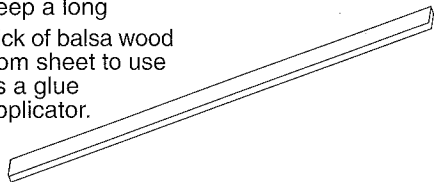

C. Lay sandpaper, rough side up, on table. Stack fins together and lightly sand the edges smooth.

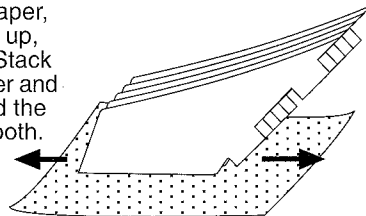

5.

DO NOT GLUE YET!

- A. Insert engine mount just inside body tube and push into place with tail cone.

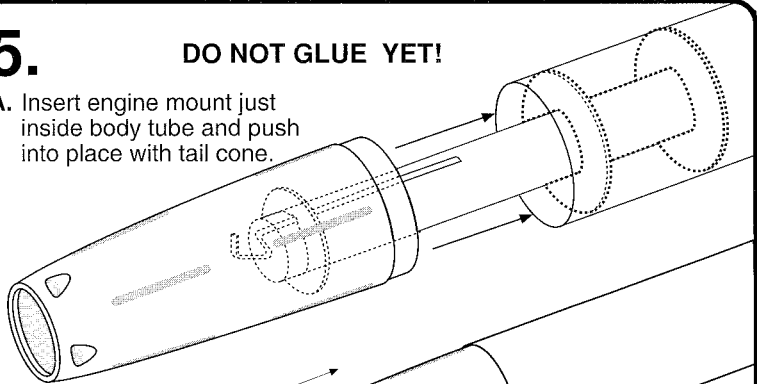

- B. Push tail cone all the way in.

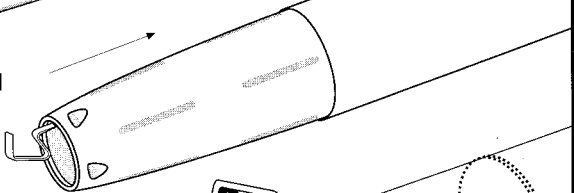

- C. Remove tail cone. **Do not disturb the position of the engine mount.**

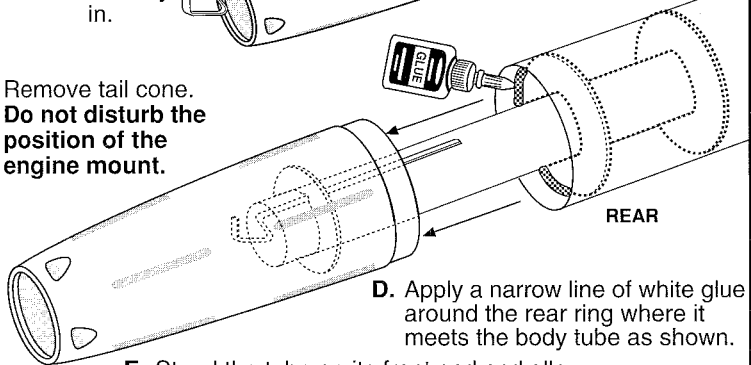

- D. Apply a narrow line of white glue around the rear ring where it meets the body tube as shown.

- E. Stand the tube on its front end and allow glue to dry for several minutes.

6.

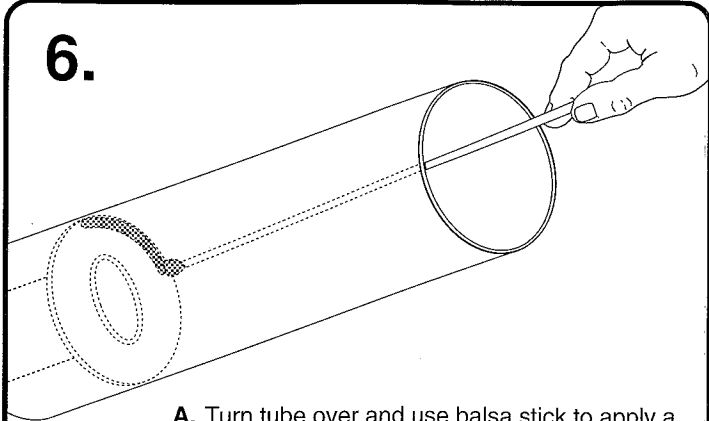

- A.** Turn tube over and use balsa stick to apply a line of white or yellow glue around the forward centering ring where it meets the body tube.
- B.** Hold the tube upright while the glue sets. (Be careful not to disturb the glue joints at rear of body tube.)

7.

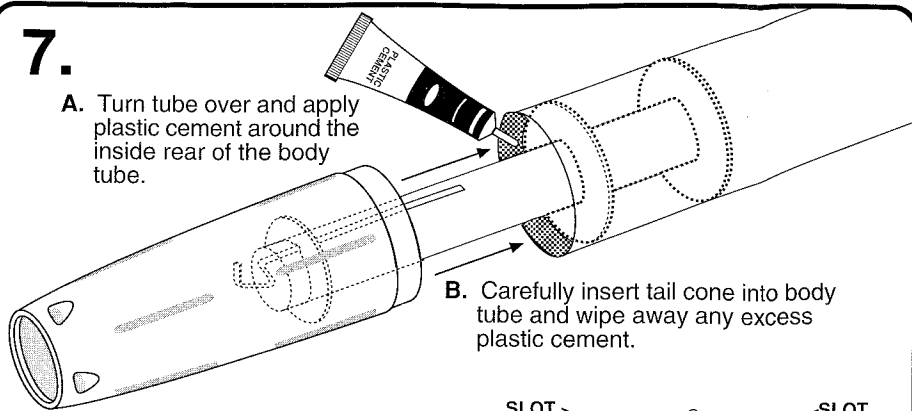

- A.** Turn tube over and apply plastic cement around the inside rear of the body tube.

- B.** Carefully insert tail cone into body tube and wipe away any excess plastic cement.

- C.** Before cement sets turn tail cone to position engine hook between two slots.

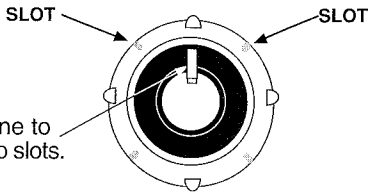

8.

A. Look at rear of rocket and sight up from engine hook.

B. Make a mark on the body tube in line with engine hook.

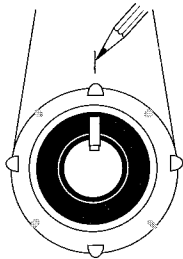

C. Draw a straight line along the body tube from mark.

NOTE: A door frame can be used to do this, but we recommend the Estes Rocket Builder's Marking Guide (EST302227)

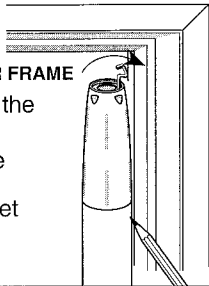

D. Use a ruler to mark the straight line at 19.1 cm (7-1/2") from the front end of the body tube.

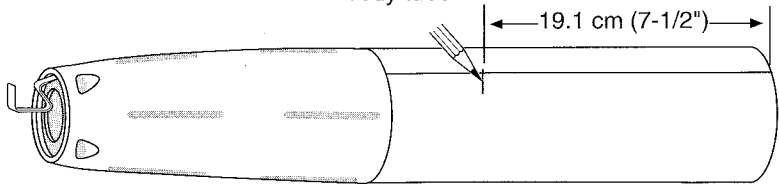

E. Apply glue to launch lug and set the rear of lug at the 19.1 cm (7-1/2") mark. Be sure the lug is perfectly aligned with the straight line you drew and allow glue to dry.

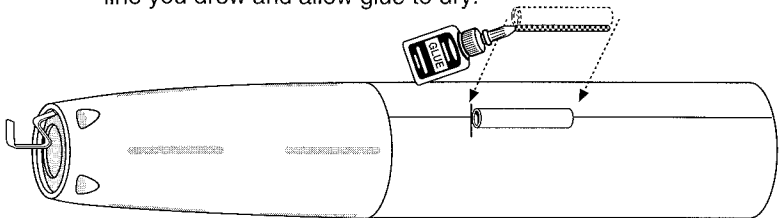

9. **A.** Test fit balsa fins into slots on tail cone and sand slots or tabs as necessary to insure a secure fit.

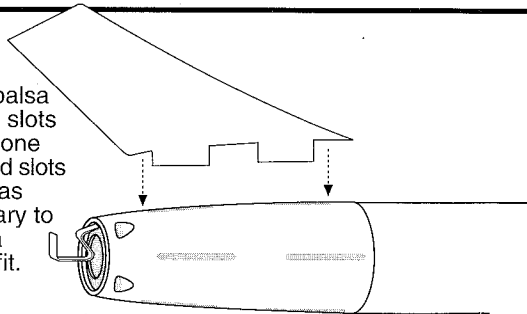

B. Once you are satisfied with the fit, apply glue to the fin tabs and insert as shown. BE SURE THE FINS ARE STRAIGHT AND 90° TO THE TAILCONE.

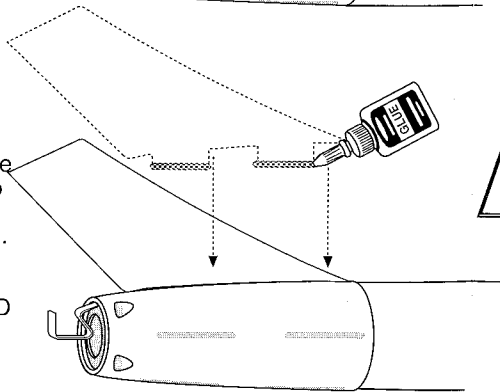

C. After glue is completely dry, apply a glue reinforcement (fillet) to both sides of the launch lug and a plastic cement fillet to both sides of fins. Smooth fillets with finger.

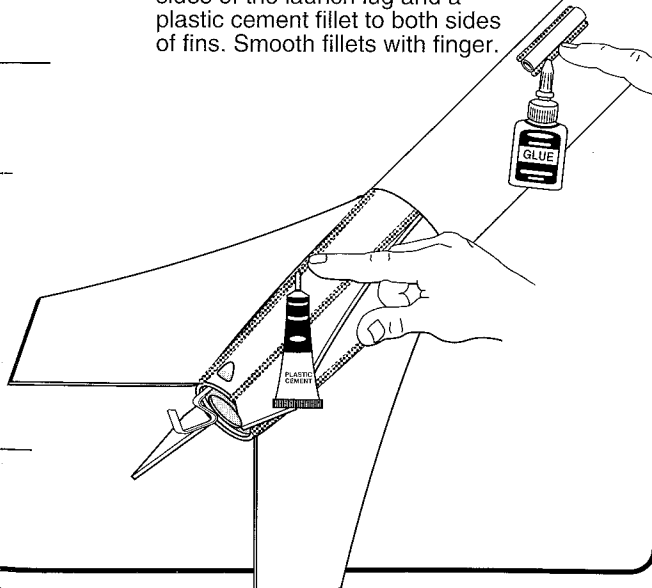

10.

- A. Cut out shock cord mount (right) along solid lines. Crease on dotted lines by folding.

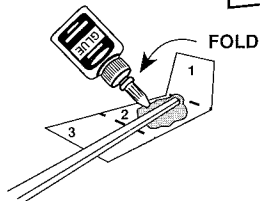
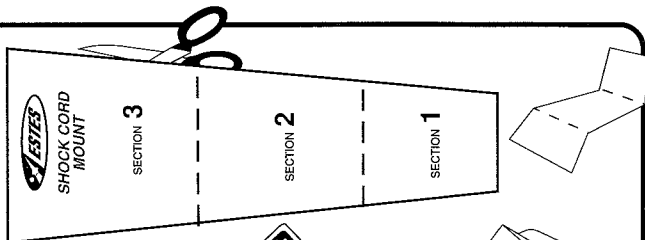

- B. Spread glue on section 2 and lay shock cord into glue at a slight angle as shown.

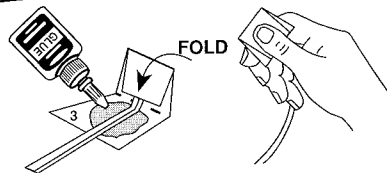

- C. Apply glue to section 3. Fold forward again. Clamp firmly until glue sets.

- D. Push the shock cord mount about 3.8 cm (1-1/2") down inside the front of body tube and press firmly in place against the inside wall of the tube. Be sure it is glued securely in place.

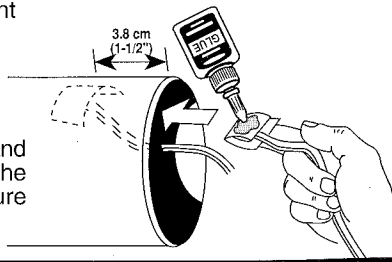

11.

- A. Cut out parachute on dotted line.

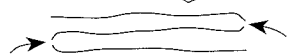
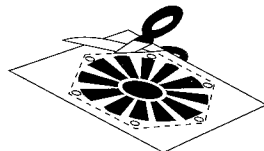

- B. Find shroud line material. Remove tape. Using all of the shroud line, fold and cut into three equal lengths.

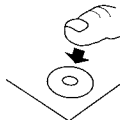

- C. Press tape rings onto marks on corners.

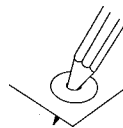

- D. Punch holes with sharp pencil.

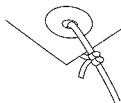

- E. Tie lines off with double knots.

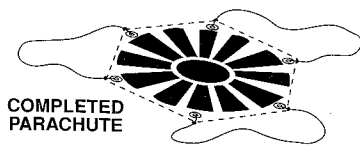

12.

A. Form loop with shroud lines.

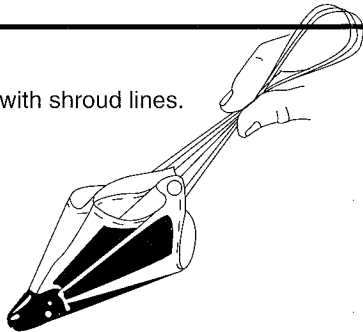

B. Push loop through eye of nose cone. (You may need to use a hobby knife to carefully remove any excess plastic from eyelet. BE SURE YOU DON'T CUT OFF EYELET.)

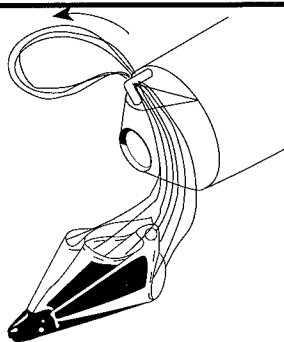

C. Pass parachute through loop.

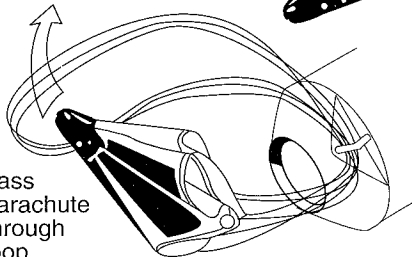

D. Pull tight.

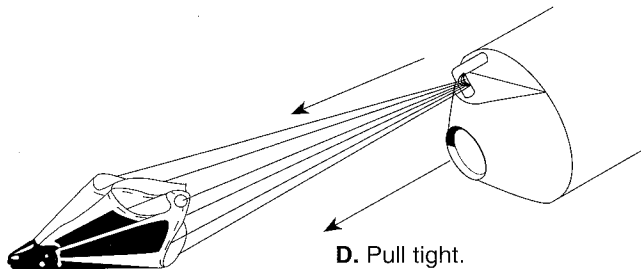

E. Tie shock cord to the eye of the nose cone with a double knot.

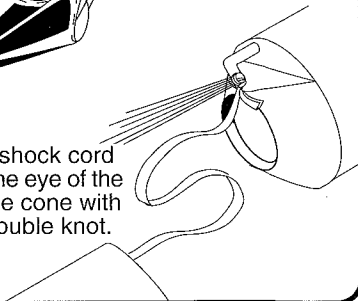

13. PACKING PARACHUTE

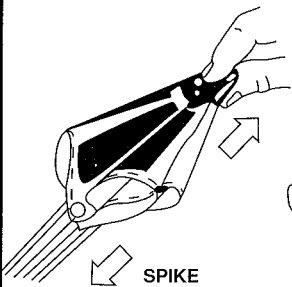

SPIKE

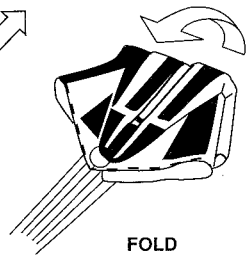

FOLD

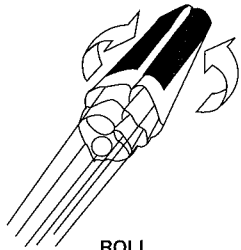

ROLL

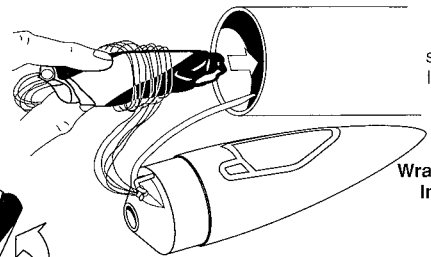

Wrap lines loosely around 'chute.
Insert parachute into rocket.

Recovery device should
slide easily into body tube.
If fit is too tight, unfold and
repack again.

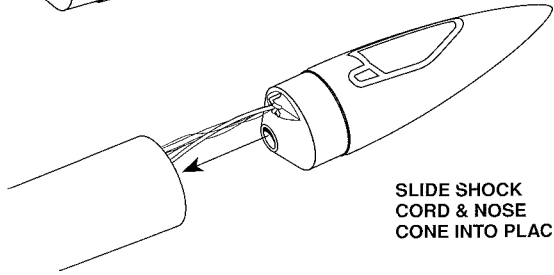

SLIDE SHOCK
CORD & NOSE
CONE INTO PLACE.

DO NOT FORGET TO PACK RECOVERY WADDING IN THE ROCKET BEFORE FLYING.

14.

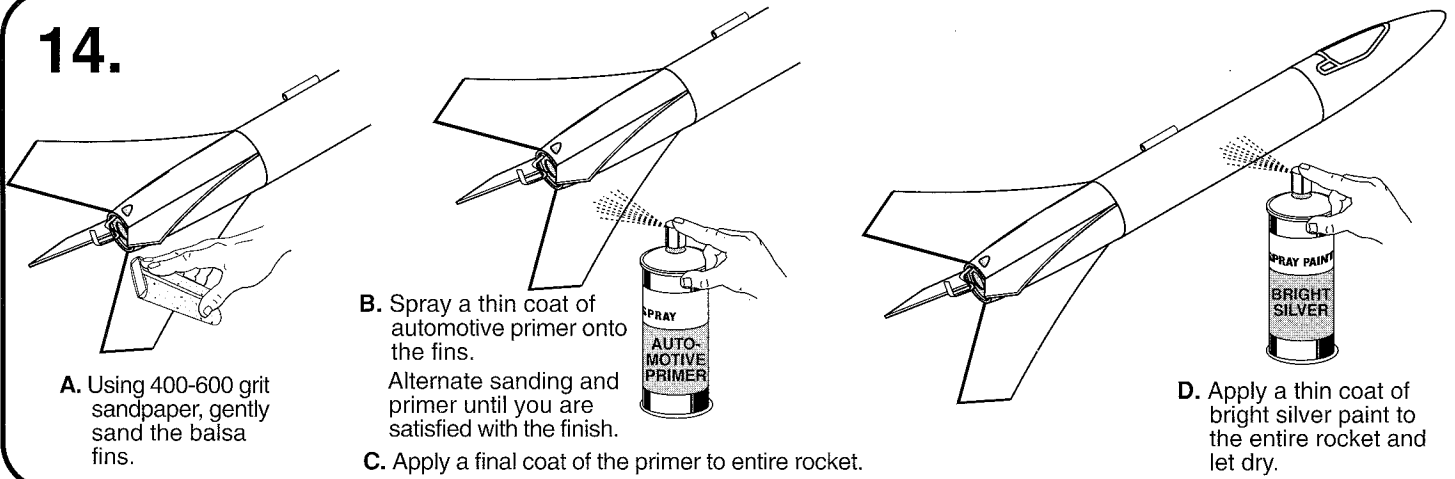

A. Using 400-600 grit sandpaper, gently sand the balsa fins.

B. Spray a thin coat of automotive primer onto the fins. Alternate sanding and primer until you are satisfied with the finish.

C. Apply a final coat of the primer to entire rocket.

D. Apply a thin coat of bright silver paint to the entire rocket and let dry.

15.

A. Cut out each decal inside dotted lines. Refer to the photo of rocket for decal location.

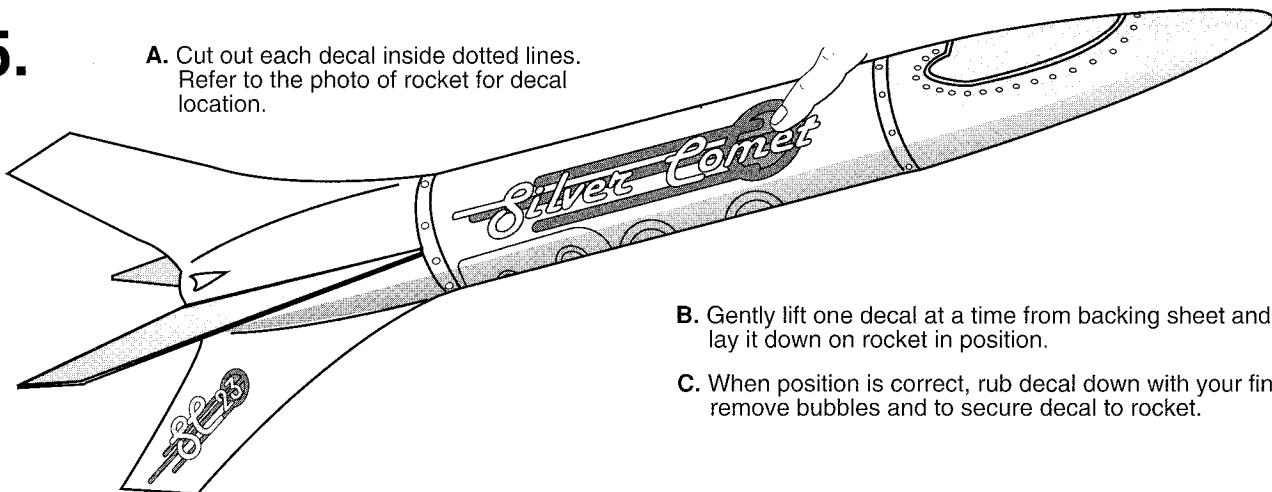

B. Gently lift one decal at a time from backing sheet and lightly lay it down on rocket in position.

C. When position is correct, rub decal down with your finger to remove bubbles and to secure decal to rocket.

16.

FLYING YOUR ROCKET

ROCKET PREPARATION

Remove nose cone, shock cord and parachute.

Crumple and insert five squares of recovery wadding. Repack and insert parachute, shock cord and nose cone.

ENGINE PREPARATION

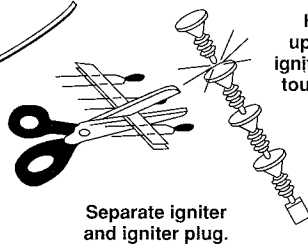

Separate igniter and igniter plug.

Hold engine upright, drop in igniter. Igniter must touch propellant.

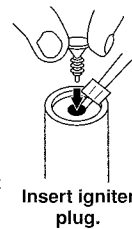

Insert igniter plug.

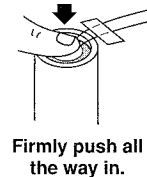

Firmly push all the way in.

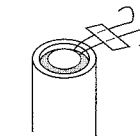

Bend igniter wires back.

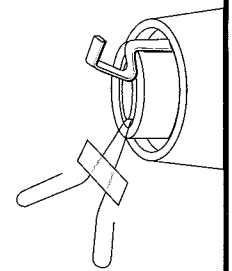

Insert engine into rocket.

LAUNCH SUPPLIES

To launch your rocket, you will need the following:

- Launch Pad (Estes Porta-Pad® II)
 - Launch Controller (Estes Electron Beam®)
 - 5 mm (3/16") Maxi™ Launch Rod (302244)
 - Recommended Estes Engines: D12-3 or D12-5. Use D12-3 for first flight.
 - Recovery Wadding (EST 302274)
 - Igniters and Igniter Plugs (included with Estes engines)
- Use only Estes products to launch this rocket.

ENGINE	PROJECTED ALTITUDE	
	Feet	Meters
D12-3/D12-5	450	138

TIPS FOR FLYING YOUR ROCKET

- Choose a large field away from power lines, buildings, tall trees, and low flying aircraft. Try to find a field at least 150 meters (500 feet) square. The larger the launch area, the better your chance of recovering your rocket.
- Launch area must be free of dry weeds and brown grass.
- Launch only during calm weather with little or no wind and good visibility.
- Don't leave parachute packed more than a minute or so before launch during cold weather (colder than 4° C [40° Fahrenheit]). Parachute may be dusted with talcum or baby powder to avoid sticking.
- Always follow the National Association of Rocketry (NAR) MODEL ROCKETRY SAFETY CODE while participating in any model rocketry activities. The safety code is enclosed with this kit.

COUNTDOWN AND LAUNCH

10... Safety key must not be in launch controller.
The safety cap with safety key attached should already be on the launch rod.

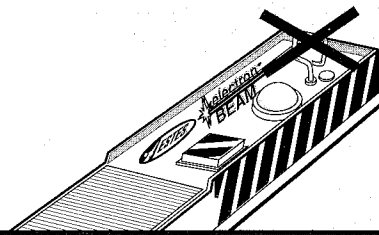

9... Remove safety cap from launch rod, slide launch lug over rod. Make sure rocket slides freely and micro-clips are clean for good electrical contact.

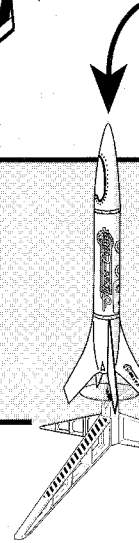
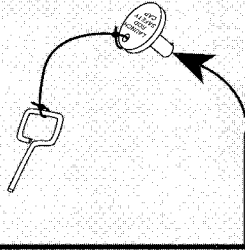

8... Attach micro-clips to the igniter wires. Arrange the clips so they do not touch each other or the metal blast deflector. Attach clips as close to protective tape on igniter as possible.

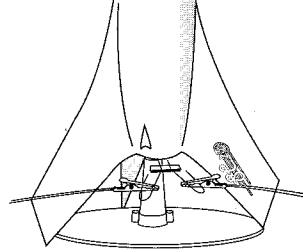

7... Move everyone back from your rocket as far as launch wire will permit (at least 5 meters - 15 feet).

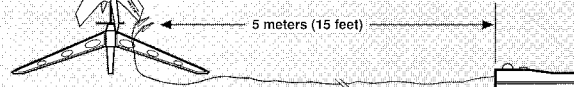

6... Insert safety key to arm the launch controller.

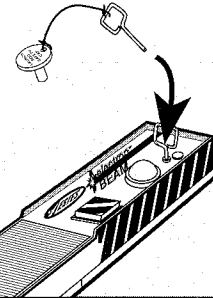

5... Start audible countdown.

4...3...2...1.....

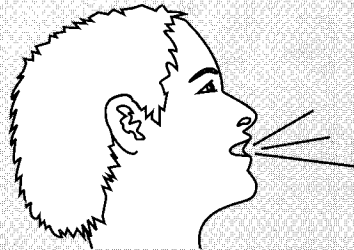

LAUNCH!

Push and hold button until engine ignites.

For safety, immediately remove safety key from launch controller and replace safety cap on launch rod.

MISFIRES

When an ignition failure occurs, **remove the safety key from the launch control system and wait one minute before approaching the rocket.** Remove the expended igniter from the engine and install a new one. Be certain the coated tip is in direct contact with the engine propellant. Broken or chipped coating will not affect the performance of the igniter. Reinstall the igniter plug as illustrated previously. Repeat the countdown and launch procedure.

Estes #2141
Silver Comet
Fin Pattern
x4

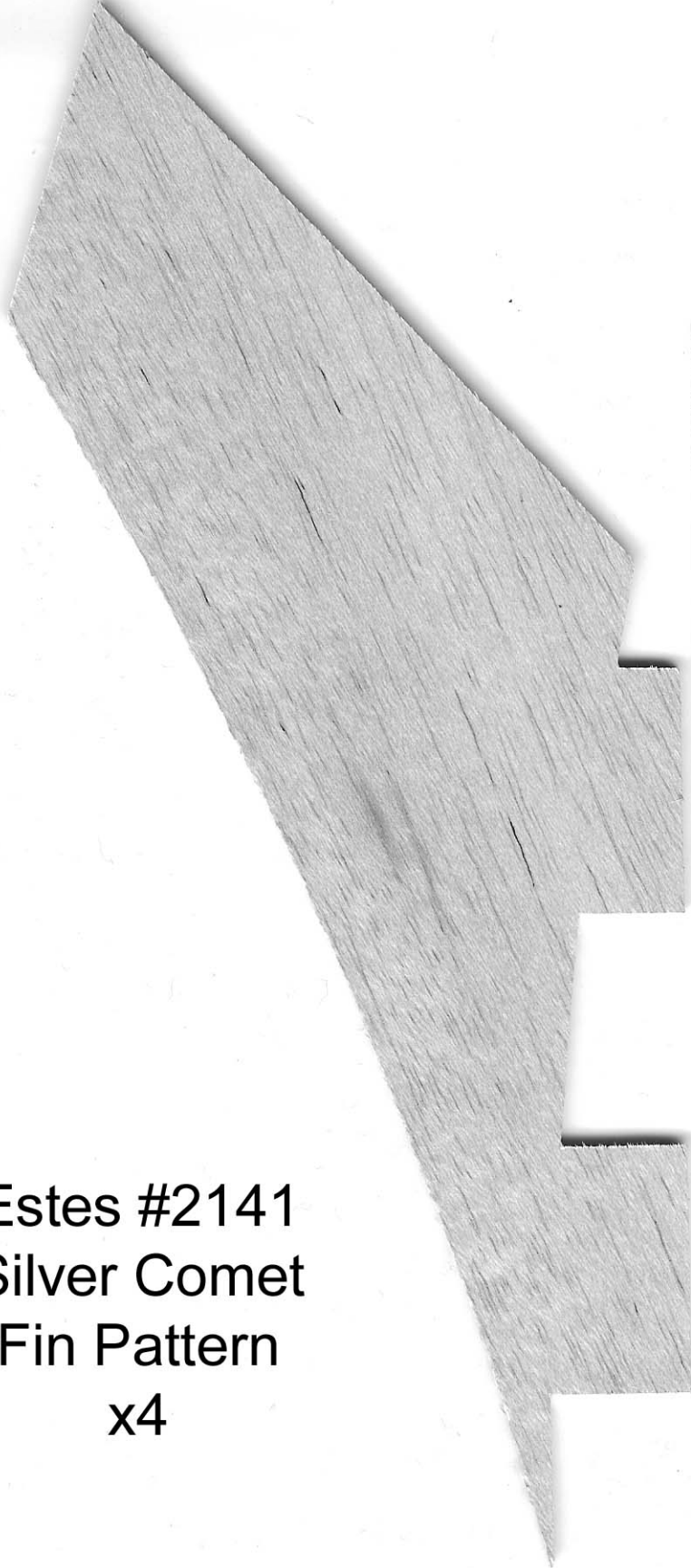

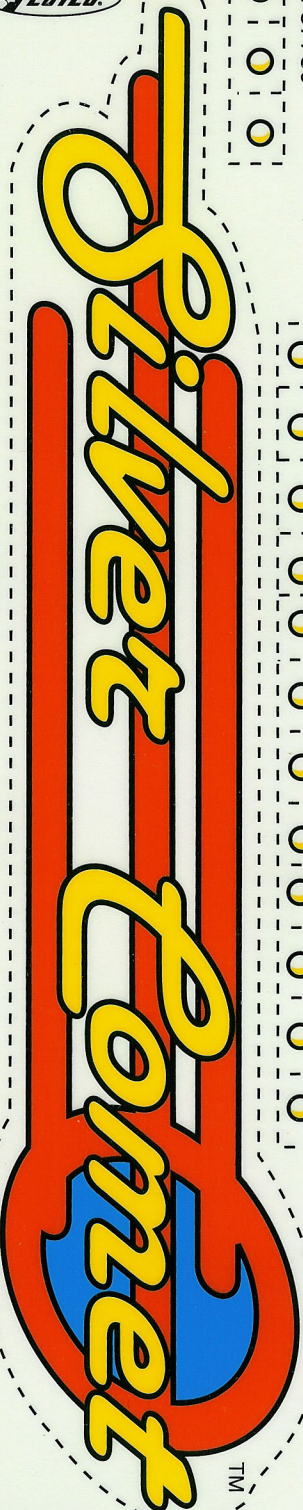

TM

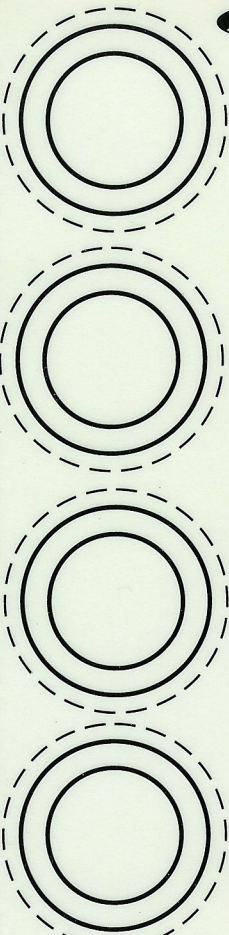

CUT INSIDE DOTTED LINE

