

\$100

Centuri

model rocket

designers MANUAL

Step-by-step instructions
on how to design and
build model rockets

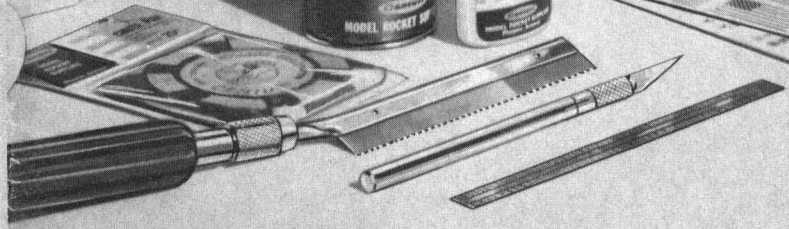
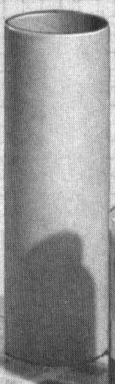
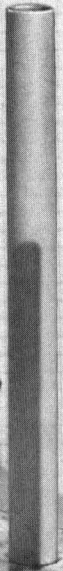

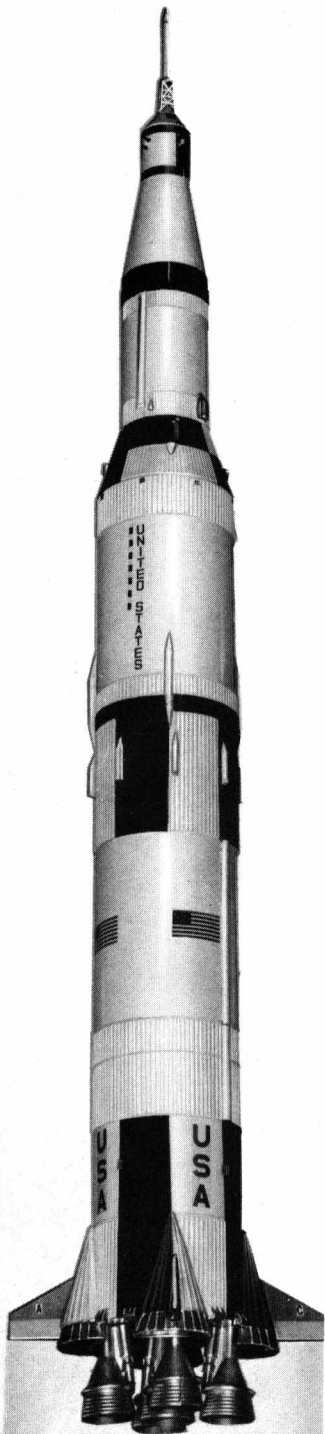

Centuri

Design Manual

introduction

Centuri publishes numerous technical reports which deal, in depth, with specific aspects of model rocketry. Upon being initiated into the hobby, we're certain you will wish to further explore these fascinating subject areas. In the meantime, this Design Manual is offered to help you get started in model rocketry. Written in layman's terms, this booklet will instruct you in basic design and construction techniques and will provide groundwork for your future ventures into the area of custom building.

Index

Chap. 1: THE MODEL ROCKET	Page 3
Chap. 2: MODEL ROCKET ENGINES	5
Chap. 3: BASIC DESIGN REQUIREMENTS	10
Chap. 4: BUILDING TOOLS AND MATERIALS	17
Chap. 5: THE CENTURI CUSTOM DESIGN PARTS SYSTEM	18
Chap. 6: CONSTRUCTION TECHNIQUES	20
Chap. 7: FINISHING THE ROCKET	24
Chap. 8: MULTI-STAGING	26
Chap. 9: LARGE SCALE MODEL ROCKETRY	27
Chap. 10: 4 MODEL ROCKETS YOU CAN BUILD	28



CENTURI ENGINEERING COMPANY

P. O. Box 1988, Phoenix, Arizona 85001.

Chapter 1:

The Model Rocket

A MODEL ROCKET IS ACTUALLY A VERY SIMPLE VEHICLE, CONSISTING OF ONLY SIX BASIC COMPONENTS. THEY ARE:

1 NOSE CONE

A cap for the forward end of the body, it is designed to direct the airflow smoothly around the rocket.

2 BODY TUBE

Basic rocket airframe. All other parts of the rocket are either attached to it or are carried inside it.

3 RECOVERY

Usually consists of a parachute attached to the body and nose cone by means of an elastic shock cord. Ejected at the peak altitude of the rocket's flight, the recovery system lowers the rocket slowly and safely to the ground.

4 LAUNCH LUG

Guides the rocket along the launching rod until sufficient speed is produced to allow the fins to provide flight stability.

5 FINS

Located at the aft end of the rocket, they serve to guide the rocket in a straight flight path.

6 ENGINE MOUNT

Designed to center and hold the engine in the body tube. Also transmits engine thrust to the airframe.

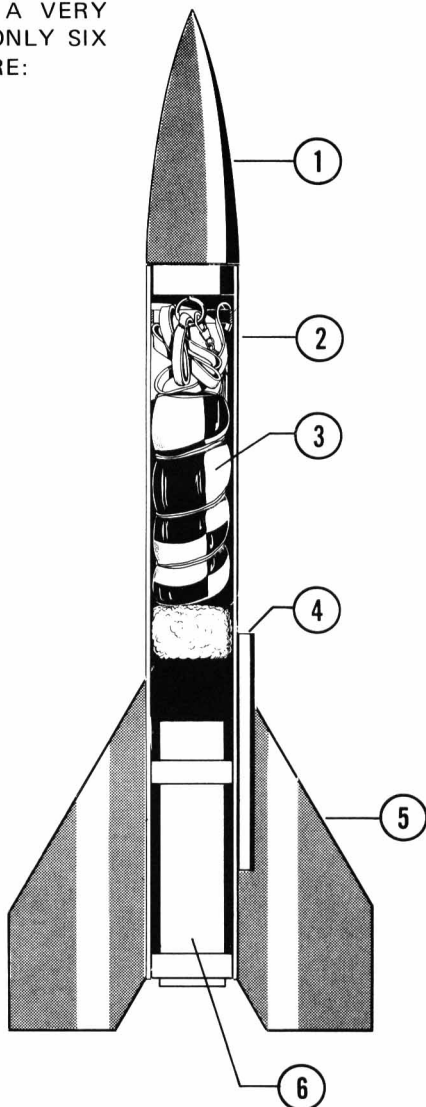

HOW DOES A MODEL ROCKET WORK?

5 APOGEE

Apogee as the rocket reaches peak altitude and begins descent.

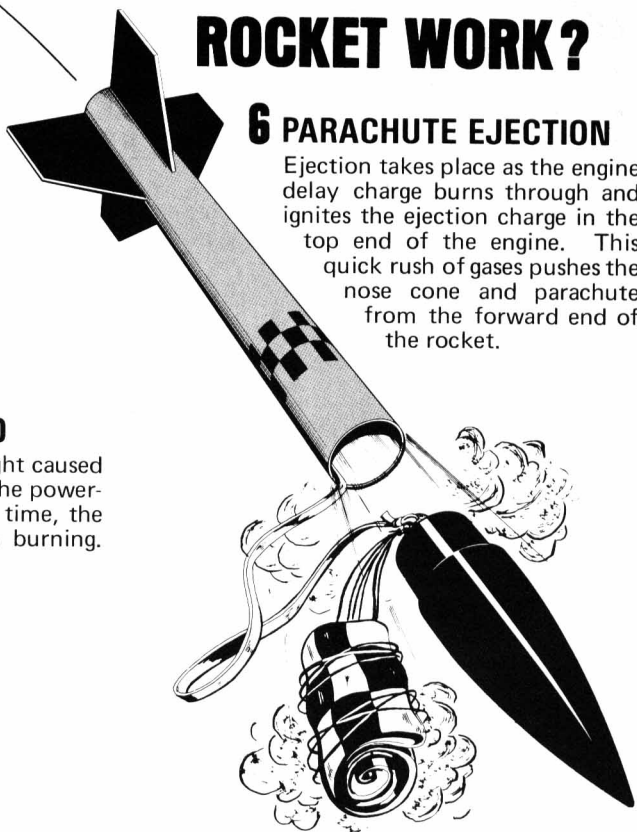

6 PARACHUTE EJECTION

Ejection takes place as the engine delay charge burns through and ignites the ejection charge in the top end of the engine. This quick rush of gases pushes the nose cone and parachute from the forward end of the rocket.

4 COASTING PERIOD

Coast period of the flight caused by thrust produced in the powered phase. During this time, the engine delay charge is burning.

3 BURNOUT

Burn out of the powered flight portion of the rocket engine.

2 LIFT OFF

Lift-off of the rocket from the launch pad.

1 IGNITION

Ignition of the rocket engine by remote electrical means.

7 SOFT LANDING

Slowly descending rocket lands safely, undamaged and ready for another thrilling flight.



Chapter 2: Model Rocket Engines

Model rocket engines accomplish two main purposes: 1—they provide power for boosting a model rocket to peak altitude, and 2—after a pre-determined delay time, they provide the ejection force which activates the rocket's recovery system. The standard ½A through C category of model rocket engines consists of the following basic components:

1. ENGINE CASING:

Made of strong, lightweight rolled paper, the casing houses the engine components safely and effectively.

2. NOZZLE:

Formed from a special clay, the nozzle is designed to produce the maximum amount of thrust from the propellant.

3. PROPELLANT:

Carefully controlled mixtures of solid propellant components are pressed under very high pressures into the casing to provide a safe, yet powerful thrust level.

4. DELAY CHARGE: *

Made of an extremely even burning material, the delay charge dictates the amount of time that will elapse between the end of the powered phase of flight and the firing of the ejection charge.

*Booster type engines do not contain a delay charge or ejection charge. See "Delay Times" in this chapter.

5. EJECTION CHARGE: *

A loose granular charge secured by a paper cap. This charge, ignited from the "burn through" of the delay material, creates a gas powerful enough to force the nose cone and recovery system from the top of the body tube.

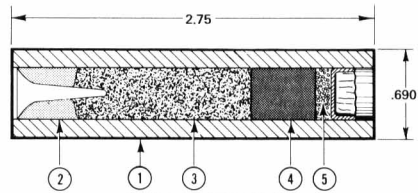

END BURNING

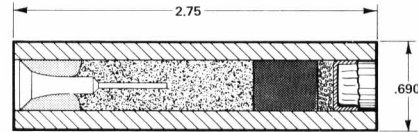

PORT BURNING

WHICH ENGINE?

Model rocket engines are divided into categories based upon the total impulse they produce in the measurement of Newton-seconds. (Refer to chart below). These categories, determined by the National Association of Rocketry, are standardized for all manufacturers in the model rocket industry. The categories are divided by the letter designations of ½A, A, B, C, D, E, and F. Of primary concern here are the ½A through D categories. (E and F engines and their use are discussed in Chapter 10). The engine with the lowest rating is the ½A class. From there, each succeeding letter class has more power, with the F class being the most powerful engine available in the model rocketry field.

CODED TOTAL IMPULSE CHART	ENGINE TYPE	TOTAL IMPULSE IN NEWTON-SECONDS	TOTAL IMPULSE IN POUND-SECONDS
	½A	0.626 to 1.25	0.15 to 0.28
A	1.26 to 2.50	0.29 to 0.56	
B	2.51 to 5.00	0.57 to 1.12	
C	5.01 to 10.00	1.13 to 2.24	

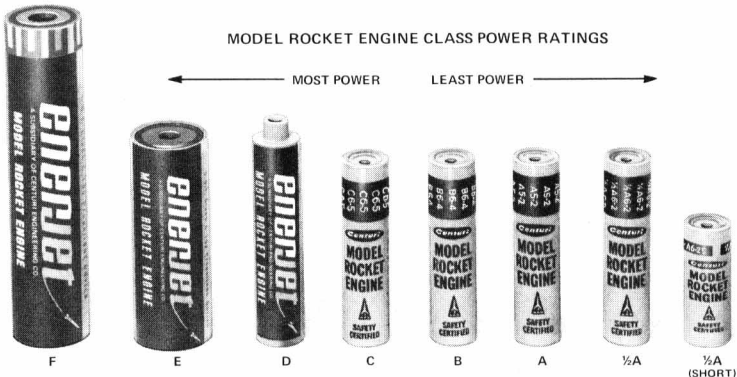

ENGINE LABEL CODING

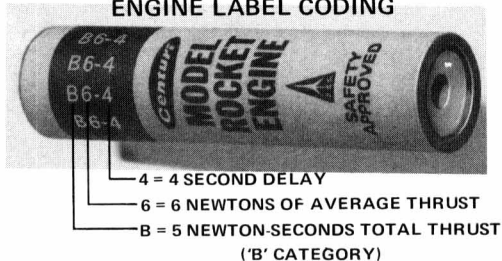

Further category division of engines is based upon the average thrust of the engine during its burn time and is designated by a number. This category can best be explained with the following example: An A-8 engine has an average thrust of 8 Newtons* while an A-5 engine has an average thrust of only 5 Newtons. Since the engines are both of the 'A' category (total impulse of 2½ Newton-seconds), how can the average thrust differ? Simple, the A-8 engine has a high thrust level, but burns for only 1/3 second. The A-5 engine, while it has a lower thrust level, burns for 1/2 second. In other words, the higher numbered A-8 engine has more "push", but less "push time" than the slower burning A-5 engine.

Another example which shows more of a variance is in the 'B' category. A B-14 engine has more than twice as much average thrust as a B-4 engine. The B-4 engine, however, burns almost 4 times as long as the hotter B-14. Both engines come out with the same amount of total impulse; 5 Newton-seconds. The reason that several different power ratings are offered is because the power requirements of different rockets will vary depending upon the desired altitude, weight and frontal area of the rocket, etc. The fact that a particular type engine will work better in one rocket than in another is not really a subject for discussion here. Later on, if you wish to delve into this subject in depth, read Centuri's technical report T1R-100. For the present, just remember that the varying power requirements do exist. The recommended engines for Centuri kits are shown in the catalog and on every Centuri rocket kit package.

DELAY TIMES:

The third numeral in a rocket engine number has nothing to do with the power of that engine. This number indicates, in seconds, the delay time between burn out and ejection. Each Centuri engine is available in 3 or 4 different delay times. The reason for the different delay times is quite simple:

*A "Newton" is the metric unit of force, or, in the case of a rocket motor — "thrust".

You want the parachute to eject just when the rocket reaches the peak of its flight (apogee). If the parachute were to eject while the rocket was still climbing at a high rate of speed, the chute and shock cord might be torn from the rocket and, of course, you would be cheated of additional altitude. If the rocket were descending, the same situation (to a lesser degree) might exist. Therefore, each engine is offered in several different delays to best match the ejection with the apogee of the various rockets in the Centuri line. You will note that six engines in the catalog carry a '0' delay number. These engines have no delay or ejection charge and are intended to be used strictly as booster engines in multi-stage models (see Chapter 8). NEVER USE A BOOSTER ENGINE IN A SINGLE STAGE ROCKET.

'S' ENGINES:

You will note that 3 engines in the Centuri line carry an 'S' after the engine number. The 'S' designates this is an engine with a "short" casing (1¼" long as opposed to 2¼" standard length). These "short" engines are intended to be used with two models in the present Centuri line, the Lil' Hercules and the Firefly. Many more uses are found when you begin to design your own custom rockets.

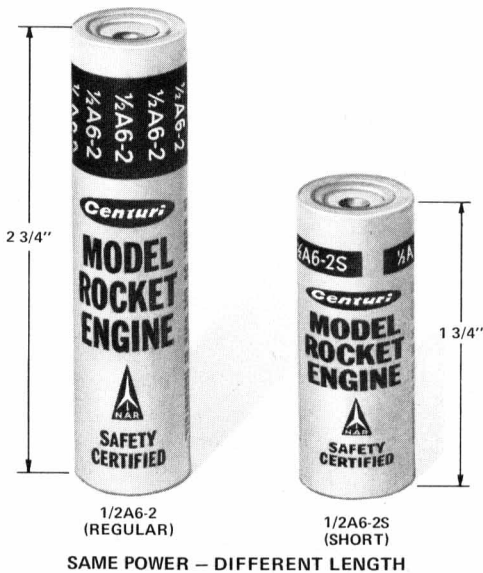

SAME POWER — DIFFERENT LENGTH

Selecting the correct delay time will insure the maximum altitude for your flights

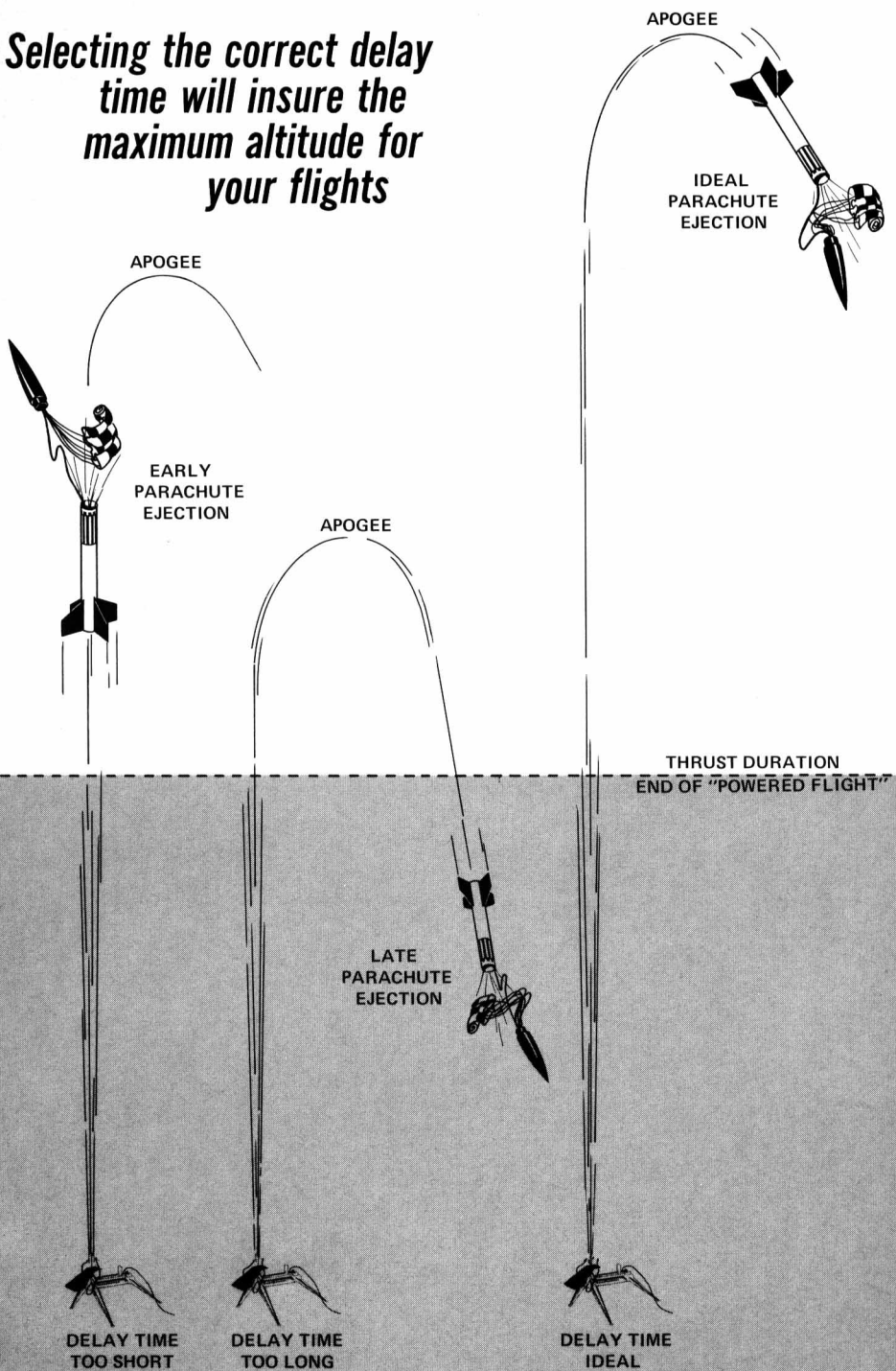

1 **ENERJET "D" ENGINE**

EQUALS 4 "B" type engines

These are the most powerful engines available for the standard line of rocket kits. The Enerjet D's are constructed like the "Large Scale" E and F type engines. They use a plastic bound, high energy composite fuel which is encased in a filament reinforced plastic casing and feature a specially engineered expansion nozzle. These engines are twice as powerful as the 'C' engine. The Enerjet D engine is the same diameter as the 1/2A through C engines, but it is 1/4" longer. It will fit in any standard rocket with the exception that it cannot be held in place with an engine lock. This is no real problem since it may be friction fitted into the rocket with masking tape (many kits, because of construction, do not feature an engine lock). Because of the D engine weight difference, several of the standard rockets need modification in the form of additional nose weight only in order to effect stable flight (see Chapter 3). The D engine is not recommended for small rockets such as the Javelin. The thrust of this engine is so high that a small rocket would go out of sight and you would probably never see it again. The 'D' engine will, however, provide beautiful flights in larger rockets such as the Nike Smoke, Orion, etc. It is recommended that you do not fire a 'D' engine until you have built and flown several kits using lower powered engines. Once you have a little experience, slip an Enerjet 'D' into that favorite larger size rocket and watch it go. You'll be amazed at the power and efficiency produced by such a small package.

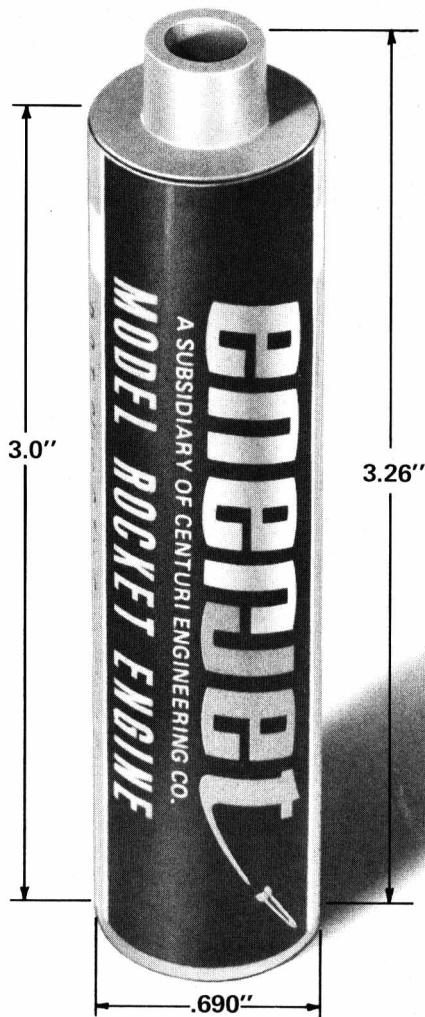

ROCKET ENGINES

Model rocket engines are produced under exacting quality and safety conditions on precise and expensive automated machinery. The engines are intended for one time use and cannot be reloaded by the individual. This is one of the important factors in the marvelous safety record enjoyed by this hobby. No propellant loading or mixing is ever done by the individual rocketeer. To follow through on safety, you the rocketeer must always use these engines as intended, in a stable launching pad, and always ignited by remote electrical means.

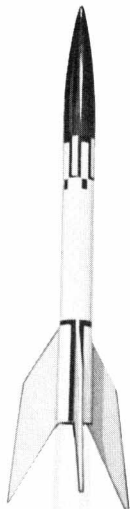

CENTURI'S "SERVO-LAUNCHER" and "ASTRO 1" Rocket Kit illustrated.

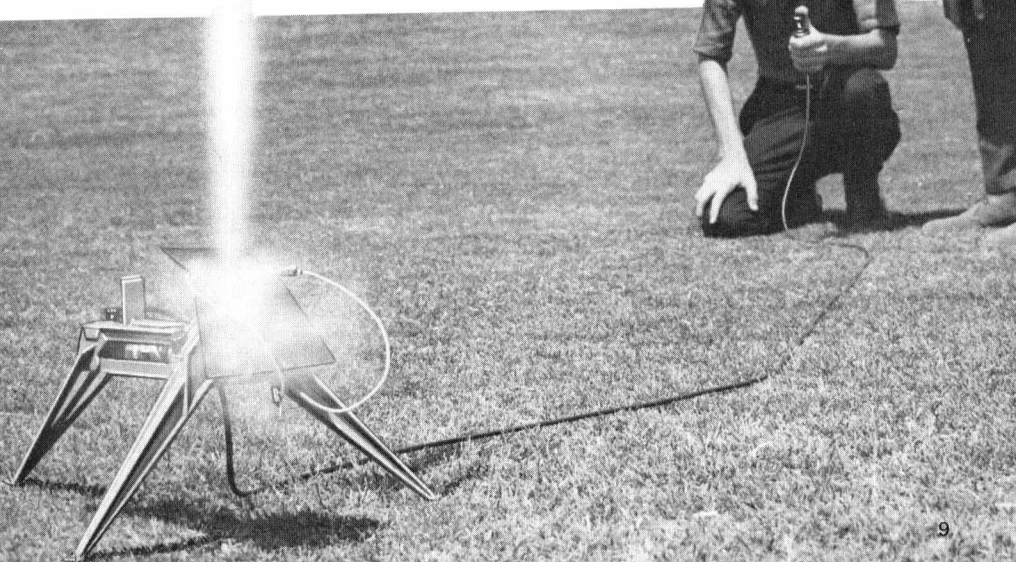

Chapter 3: Basic Design Requirements

STABILITY: There are two primary factors which influence the flight stability of a model Rocket.

1. **Center of Gravity:** the point at which the rocket balances.
2. **Center of Pressure:** the theoretical point at which all forces directed against the rocket would center.

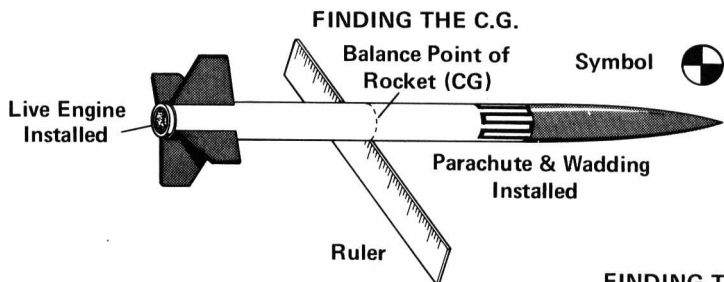

In order for a model rocket to fly stable, the center of gravity must be ahead of the center of pressure. Always remember this rule in designing your model rockets. The center of gravity is quite easy to determine. Simply balance the rocket (with live engine in place, chute wadding, etc. installed) on a ruler or thin piece of wood. The point at which the rocket balances is the center of gravity. (Abbreviated CG.) The approximate center of pressure may be found by making an exact size cutout of the rocket from cardboard. This cutout is balanced on the ruler to show the center of pressure (CP). Note: the formulas for determining the true CP of a rocket are discussed fully in Centuri's Technical Report TIR-33. In order for a rocket to have a reasonable stability margin, the CP should be at least one body diameter* behind the CG.

FINDING THE C.P.

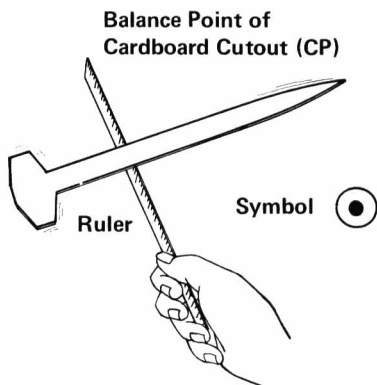

STABILITY TEST:

The easiest way to determine if the rocket will really fly stable involves the use of the swing test. Prepare the rocket as you would for launching. Use the heaviest engine you would ever fly in the rocket.

*This figure applies only to this method of calculation of CP-CG.



SWING TESTING FOR STABILITY

The rocket must be fully "flight prepped" with the exception of the igniter. Locate the balance point of the rocket (CG). Tie a loop in a 10 foot piece of cord and place around the rocket at the CG point. Tape the cord to the body so it will not slip forward or backward. Hold the rocket at

COMPLETED MODEL

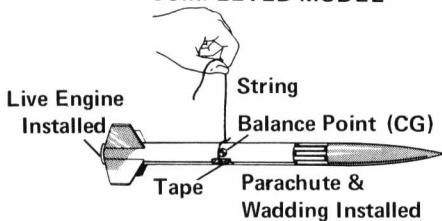

arms length, point the rocket's nose in the direction you will swing and begin to swing the rocket around your head. As the rocket picks up speed, let the cord out to about 8'. If the nose of the rocket points in the direction you are swinging and stays pointed that way, the rocket will fly stable. If it twists, turns flat against the wind or if the tail of the rocket turns forward, the rocket does not have sufficient stability. Note: on very large rockets, a longer cord is necessary. In order to get a reliable test, for instance, on a Centuri Saturn V, you would have to stand on a high platform and swing the rocket in a 20' arc.

CORRECTING INSTABILITY:

One way to correct instability is to move the CP to the rear. Enlarging the fins or extending them rearward will accomplish this. An easier method (especially if the rocket is completed) is to move the CG forward. This is done by adding weight to the nose of the rocket. After any alterations are made, the rocket must be re-tested to verify stability. Remember that the CG will change when you modify the rocket, so locate the new CG before flying

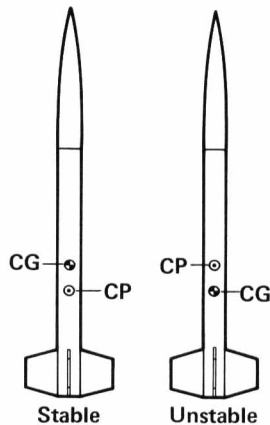

CORRECTING INSTABILITY

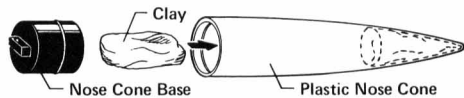
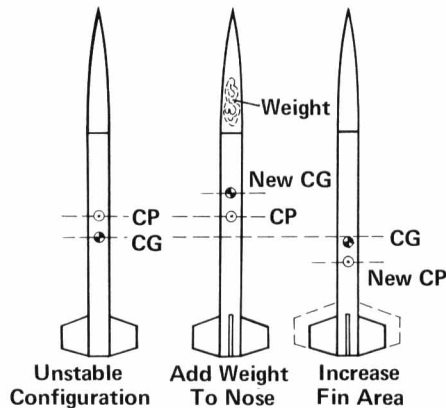

To advance the center of gravity on a rocket a wad of modeling clay can be pushed into the extreme end of the plastic nose cone prior to snapping the base into place.

DRAG:

Drag is the resistance created by a body moving through the air. There are several types of drag that influence the performance of a model rocket. Rather than go into a prolonged discussion of aerodynamic drag at this point, we'll just mention a few things you can do to reduce drag on your model rocket.

FINISH:

A good finish on your rocket (see Chapter 7) is important in reducing the friction experienced in flight. The better the finish, the higher the flight.

NOSE CONE:

Although tests show this is not as critical as was once thought, a parabolic shaped cone is the most optimum shape for reducing drag on subsonic flight models. (See top of page 13.)

FINS:

The shape of the fins has some effect on drag. A swept back fin with rounded corners will generally produce a little less drag than a fin with sharp corners. Of greater importance in reducing drag (especially in the case of a light weight rocket) is the cross section shape of the fin. A gently rounded leading edge and a tapered trailing edge on a fin will produce less drag than a fin on which all edges are square or just rounded. Drag is also produced in the area where the fins join the body tube. Fillets along the fin-body joints (see Chapter 6) will reduce this "interference drag".

BOAT TAIL:

Curving the rear portion of the rocket inward will reduce base drag at this point. This is of course, only possible on rockets that have an inside body diameter larger than that of a model rocket engine.

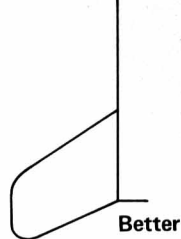
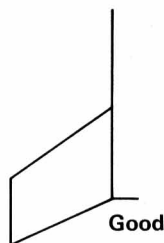

Fin Cross Section Shape

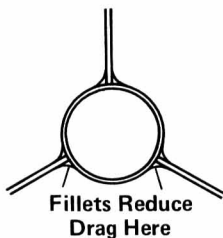

Balsa Boat Tail
(Centuri V-2)

Paper Boat Tail
(Centuri MX-774)

ROCKET COMPONENTS:

FINS:

Many different fin shapes may be used for a model rocket. Centuri's fin pattern sheet is an excellent source for fin designs. If you desire, you may purchase sheets of balsa from Centuri with fin designs printed right on the balsa. A rule of thumb in determining fin area is that each fin should be at least $1\frac{1}{2}$ times (in both directions) the diameter of the body. Fins can be cut from a single piece of balsa, or may be made up of two or more balsa sections. Remember that the grain line should always run parallel with the leading edge of the fin. The fins should be positioned to the extreme rear of the rocket.

Fins should not be placed near the front of the rocket since this tends to move the center of pressure forward and reduces the stability margin. Small, decorative fins may be placed forward, only if the main fins are quite large.

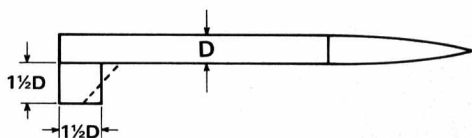
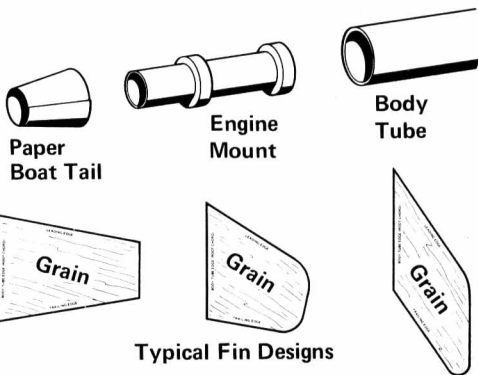

NOSE CONES:

Nose cones are available in a wide variety of sizes and shapes. The choice is up to you. In terms of performance, the relative efficiency of the shapes are shown here. Centuri produces both balsa and plastic nose cones. The Centuri plastic nose cones have a snap in base which allows the cone to be used as a payload compartment.

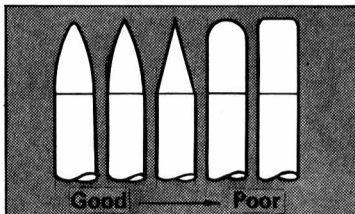

BODY TUBES:

Centuri body tubes are made of a specially rolled, hi-strength kraft paper. The wall thickness of most of these tubes is .022". This is ideal for maximum strength with the lightest weight. Centuri body tubes are finished with a poly-glassine coating which produces a very smooth finish and provides a good bond with glue or paint. Body tubes are available in a variety of sizes (see Chapter 5). A #7 tube (.76" diameter) is the smallest tube in which a model rocket engine will fit. Body tubes are available in several lengths and also may be easily cut to any desired length. In designing your first rockets, make the length of the body at least 10 times the diameter of the tube. Short rockets offer more design problems and the balance is more critical.

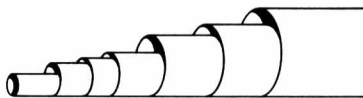

Body tubes available in lengths up to 18".

ENGINE MOUNTS:

The simplest engine mount is a thrust ring glued into a #7 body tube. In larger body tubes, a 3" long #7 tube with thrust ring is used to hold the engine. This tube is centered in the larger tube with centering rings or a ring and sleeve combination. In some cases where a #13, #16, or #20 body tube is used, the engine mount can be recessed an inch or so into the body to help increase the stability margin. (Moving the engine and its mount forward moves the CG forward.)

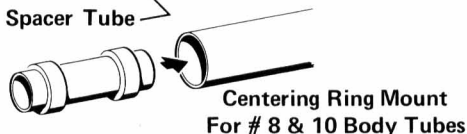
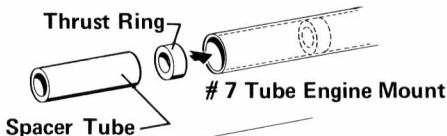

CLUSTERING:

Clustering involves the use of two or more engines, fired simultaneously, to boost a rocket which would be too large and heavy for a single engine. Centuri's Saturn 1B (2 engines) and Saturn V (3 engines) are good examples of cluster "birds". In order to have simultaneous ignition, it is absolutely necessary to use Sure Shot Igniters and a heavy duty power supply. A cluster mount is relatively simple to build. ST-73 engine tubes are fitted with thrust rings and the tubes are glued together to form the cluster. Two or three engine cluster mounts will fit nicely into a #16 body tube and a four engine mount will fit easily into a #20 tube. Be sure to read Centuri's Technical Report TIR-52 "Reliable Cluster Ignition" before attempting launch of a cluster rocket.

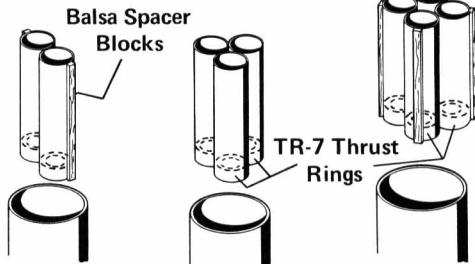
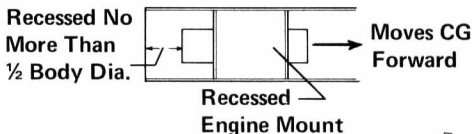

NOTE: Gaps between cluster tubes must be filled with balsa or cardboard to prevent ejection gas from escaping to the rear.



2 Engine Mount In #16 Tube

3 Engine Mount In #16 Tube

4 Engine Mount In #20 Tube

RECOVERY SYSTEMS:

The most common recovery system used on model rockets is the plastic parachute. Several other types of recovery systems are used on certain rockets. They are listed here:

A. FEATHERWEIGHT RECOVERY:

A very lightweight, small rocket which upon ejection of the spent engine casing, falls gently back to earth. The Lil Hercules is an example of this type of rocket.

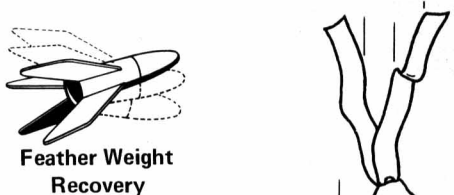

Feather Weight Recovery

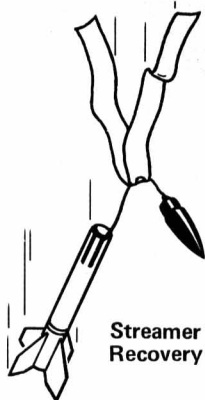

Streamer Recovery

B. STREAMER RECOVERY:

A streamer is a long ribbon made from crepe paper or plastic. Upon ejection from the rocket, the tails of the streamer flutter in the breeze and slow the descent of the rocket. Normally used on lightweight models such as the Micron, streamers may be used interchangeably with parachutes on larger models for flying in a stiff wind. Since a streamer allows the rocket to fall straight, there is less chance of drift on windy days than with a parachute.



Parachute Recovery



C. PARACHUTE RECOVERY:

The parachute ejects, fills with air and lowers the rocket gently to the ground. The size of the parachute varies depending on the weight of the rocket. Large rockets may use two or even three parachutes for recovery.

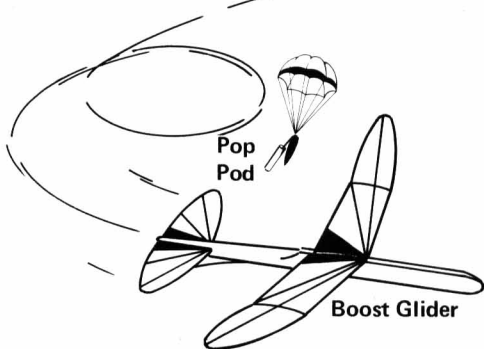

Pop Pod

Boost Glider

D. GLIDE RECOVERY:

The model glides to earth like a conventional airplane. The Swift boost glider is an example of this. In the case of the Swift, the engine is located in a separate pod which recovers with a parachute. Ejection of the pod leaves the conventional appearing, lightweight glider high in the sky to wheel and turn gently toward the earth. Boost gliders can stay aloft for considerable amounts of time. In a rocket plane such as the Mach-10, the engine remains in the plane and the glide is similar to but faster than that of the Swift.

E. RETRO SPIN RECOVERY:

The rocket is designed in such a manner that drag surfaces are deployed by the engine ejection charge. These deployed surfaces cause the rocket to spin and thus slow its descent.

Retro Spin Recovery

Rocket Plane
Glide Recovery

Engine
In Place

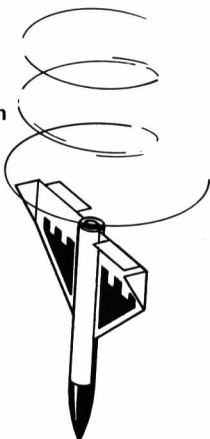

PARACHUTE DESIGN AND ASSEMBLY

Centuri offers a number of different sizes of colorful printed parachutes. Should you wish, however, to make your own chute, the construction methods are shown here. These methods can be used with a variety of materials. Recently introduced, chrome mylar is becoming quite popular. The mylar is stronger and more heat resistant than plastic and is much thinner (.0005") which allows it to be folded into a smaller chute compartment. Another advantage is the mylar's reflective surface which makes it highly visible during descent. Parachutes are occasionally made from silk, but due to its greater bulk and cost, this material is generally restricted to the Mini-Max/Enerjet field.

PARACHUTE SELECTION GUIDE			
APPROX. ROCKET DESCENT WT.	PARACHUTE SIZE		
	SQUARE	HEXAGON	OCTAGON
1 oz.	D=14"	D=13"	D=12"
2 oz.	D=18"	D=17"	D=16"
3 oz.	D=24"	D=22"	D=20"
4 oz.	D=28"	D=26"	D=24"

"D" is the width dimension of the parachute canopy as shown below.

FORMULA FOR CUTTING PARACHUTE SHROUD LINES

SHROUD LINE LOOP LENGTH	
SQUARE	2½ TO 3 TIMES "D"
HEXAGON or OCTAGON	2 TO 2½ TIMES "D"

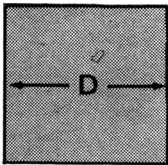

SQUARE

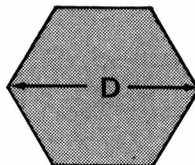

HEXAGON

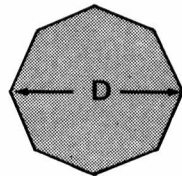

OCTAGON

Three basic parachute shapes will be discussed here. They are square, hexagon, and octagon. The table above shows the approximate size of the chute required for rockets of different weights and the recommended length of shroud lines.

SQUARE:

A square piece of material is cut to the desired size. Shroud lines are attached to the corners with tape discs. The shroud lines are pulled tight and tied to complete the chute.

Tape discs.

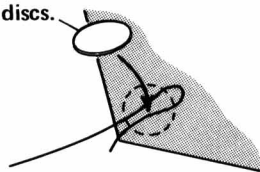

Press down firmly

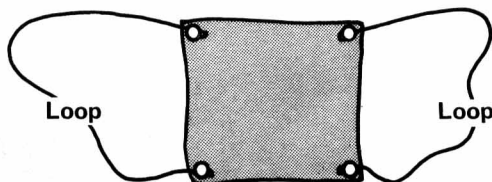
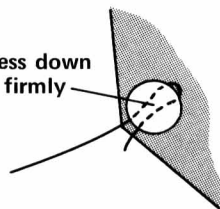

Square Chute

HEXAGON:

Cut a square piece of paper to size so that each side equals the desired dimension (D) of the chute. Fold the paper into a right triangle. Mark the paper with a 30-60-90° triangle and fold the legs over as shown. Cut across the folded paper to complete the pattern. Lay the pattern on the chute material and cut out. Attach shroud lines and tie ends to complete the chute.

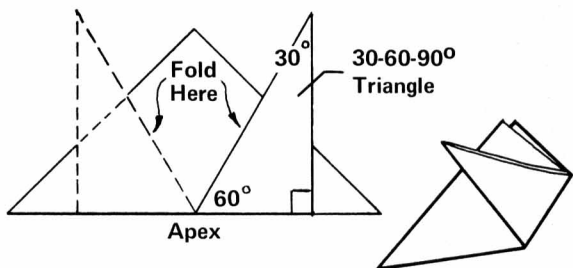
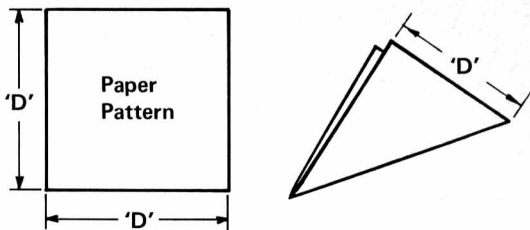

OCTAGON:

Cut the piece of paper as above, with each side equaling the desired "D" dimension. Fold the paper in half and fold again to form a square one-fourth the original size. (See below.) Fold this on a 45 degree angle. Mark length "B" equal to length "A". Draw a line across and cut to complete pattern. The chute is cut out, shroud lines are cut, attached and tied to finish the chute.

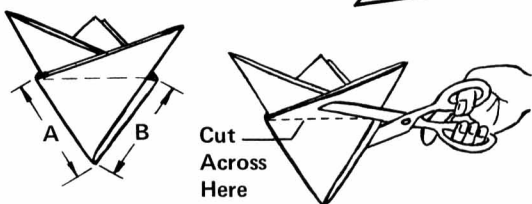

The method of attaching the chute to the rocket is described in Chapter 6. Note: If the rocket tends to drift during descent, a small spill hole can be cut in the center of the parachute. While this makes the rocket come down faster, it also reduces the drift.

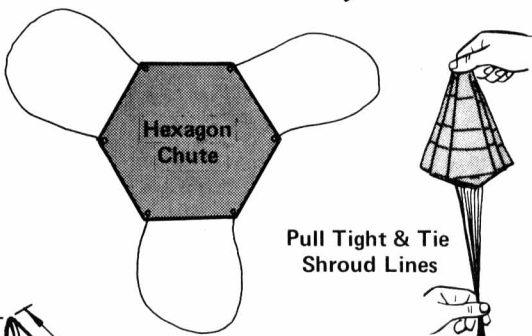

Pull Tight & Tie Shroud Lines

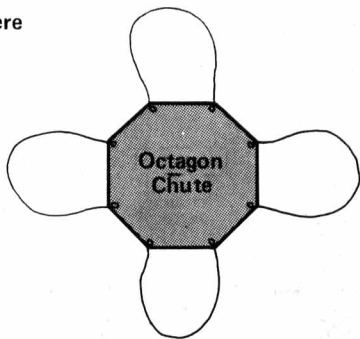
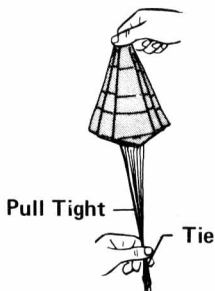
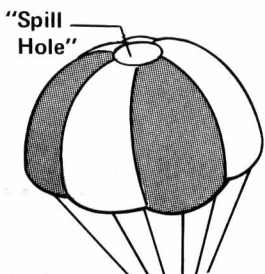
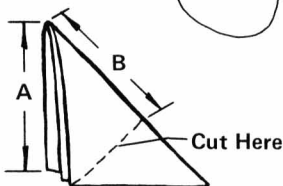
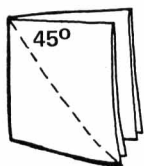
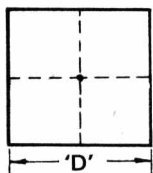

Chapter 4: Building Tools and Materials

In order to build good models, it is necessary to have the correct tools. The tools needed to build model rockets are inexpensive and few in number.

A "must" item is a modeling knife. Listed in the Centuri catalog are a number of knives and knife sets. These knives are specially designed for delicate model work. They use replaceable blades which can be discarded when they become dull. A word of caution: Always handle the knife carefully. Sharp blades will cut fingers as well as balsa. If you ever drop a modeling knife or if it rolls off the table, never—never try to catch it. This may sound funny, but it is a natural instinct to try to catch something when it falls. In this case, a natural reaction could produce a nasty cut on the hand.

A metal ruler which can be used for measuring and as a cutting straight edge is a necessary tool. A sanding block, tweezers, and scissors are also very handy to have on the work bench. Centuri's "Model Rocketeer's Tool Kit", Catalog No. XC-90, forms a very good basis for any rocketeer's tool collection. Once purchased, tools such as these almost never wear out — they are a lifetime investment.

Whether you are working at a workbench or the kitchen table, a cutting board is a standard item. Not only will it prevent marring of the table surface, but it will prolong the use life of the knife blade. A piece of heavy solid (not corrugated) cardboard makes an ideal cutting board. 12" x 18" is a good convenient size. Discarded "stand up" type signs such as the ones used in grocery stores are a good source for heavy cardboard.

Sandpaper is required in a variety of grades. Sandpaper is graded by the "grit" or relative smoothness. Listed here are the different "grits" needed for various jobs:

150 & 220 GRIT SANDPAPER: Used for "shaping" and rough sanding of balsa part.

320 GRIT SANDPAPER: Used for interim sanding of balsa — between applications of fillercoat.

420 & 600 GRIT SANDPAPER: Used for final sanding. These are very fine grades of sandpaper and produce smooth, even finishes.

Additional materials such as paint, glue, brushes, tape, etc. will complete your "model rocket work bench". These materials are discussed more fully in Chapters 6 and 7.

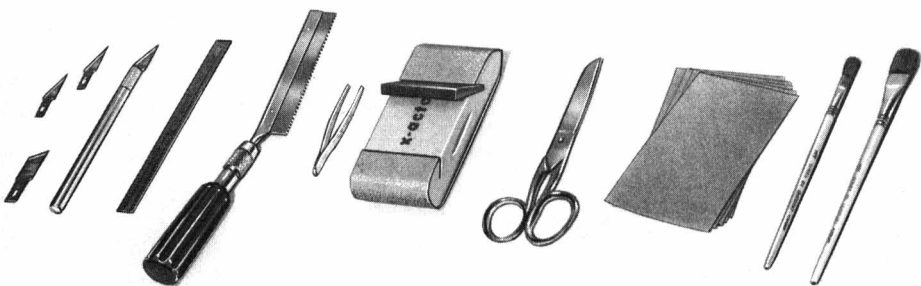

Chapter 5: Custom Design Parts System

Centuri model rocket parts are number coded in a very simple and logical system. An understanding of this system will enable you to design custom rockets with a minimum of effort.

Basic rocket components are all numbered according to the seven different series of Centuri body tubes. These series are based on the diameters of the various tubes produced. They are listed below:

Series:	Nominal inside diameter of body tube:
# 5	.5"
# 7	.7"
# 8	.8"
# 10	1.0"
# 13	1.3"
# 16	1.6"
# 20	2.0"

All parts are numbered in a combination of a letter prefix followed by a 2 to 4 digit number. The first digit (s) of the number always identify the series to which the part belongs. The last digit (s) provide identification of the specific part. The letter prefix gives a descriptive abbreviation of the part. Study the examples. They will clarify the system more fully.

Body tubes are available in a variety of lengths. 12" and 18" lengths are, however, the most economical purchases. You can cut from these longer tubes the exact lengths that you need. The #7 series tube is a glove fit for a model rocket engine. Since the #5 series tubes are too small in diameter to contain an engine, they are used only as supplemental tubes or dummy upper "stages" on a rocket. (See rocket plans.) The balsa and paper reducers can be used to combine the different series, offering an unlimited variety of possible rocket shapes. The example shown here is somewhat exaggerated in design, but does demonstrate the variety of possible combinations.

CENTURI PARTS NUMBER EXAMPLES

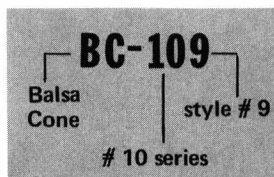
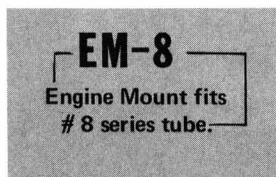
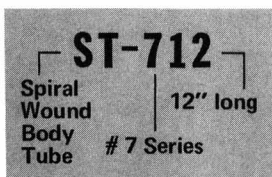
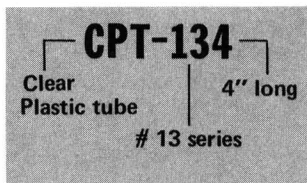
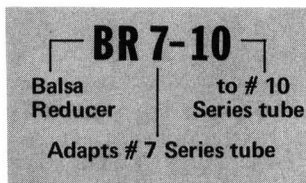

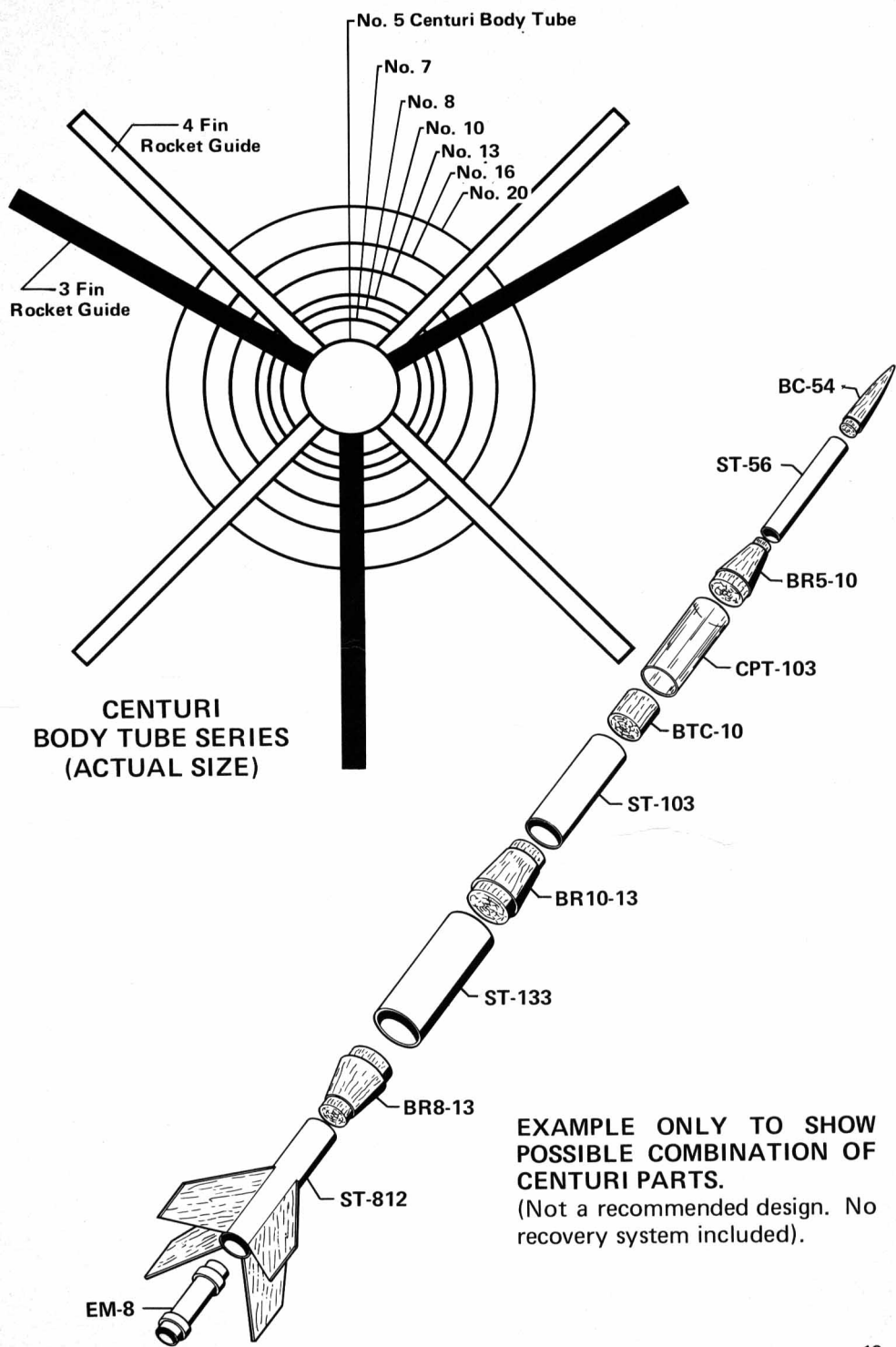

Chapter 6: Construction Techniques

CUTTING BODY TUBES:

The simplest method of cutting a body tube is to wrap a piece of paper around the tube where the cut is to be made. Place a pencil against the edge of the paper and draw a line around the tube. Lay the tube on a flat surface and rotate slowly, cutting along the pencil line with a sharp knife. Use light pressure and do not try to cut through the tube on the first pass. Once the tube is cut, dress down the end by sanding on a flat piece of fine sandpaper.

A faster and neater method for cutting body tubes involves building a simple but efficient cutting jig. Make the jig from any available wood to the approximate dimensions shown. To use, place the body tube in the jig, position the knife, blade up, on the edge of the jig at the desired cut off point. Rotate the tube slowly, keeping the knife point pressed against it. If you hold the knife firmly in place and hold the tube firmly against the stop plate, you should come out with a

perfect cut every time. To cut different diameters of tubes, modify the jig by placing flat pieces of wood on the base plate to serve as spacers.

MAKING FINIS:

Once a fin shape has been decided upon, a card stock template must be made. (PFC-15 Fin Guide Pack has pre-cut templates). Using a soft lead pencil, trace the outline of the template onto a balsa sheet. Remember — the leading edge (top) of the fin should always be parallel with the grain of the balsa.

Balsa is soft and easy to cut, but a few basic rules must be followed to produce consistently good results. Always use a metal straight edge as a cutting guide and always use a sharp knife. When cutting out fins, place the straight edge so the knife blade cuts to the outside of the fin. If the knife slips, you will only nick the scrap balsa, not the fin. Hold the knife straight and cut in several light passes. This results in a neater cut with less dulling of the blade.

If you are cutting very heavy balsa, a razor saw is better than a knife. Razor saws have a very thin blade and very small teeth, making them perfect for this type of work.

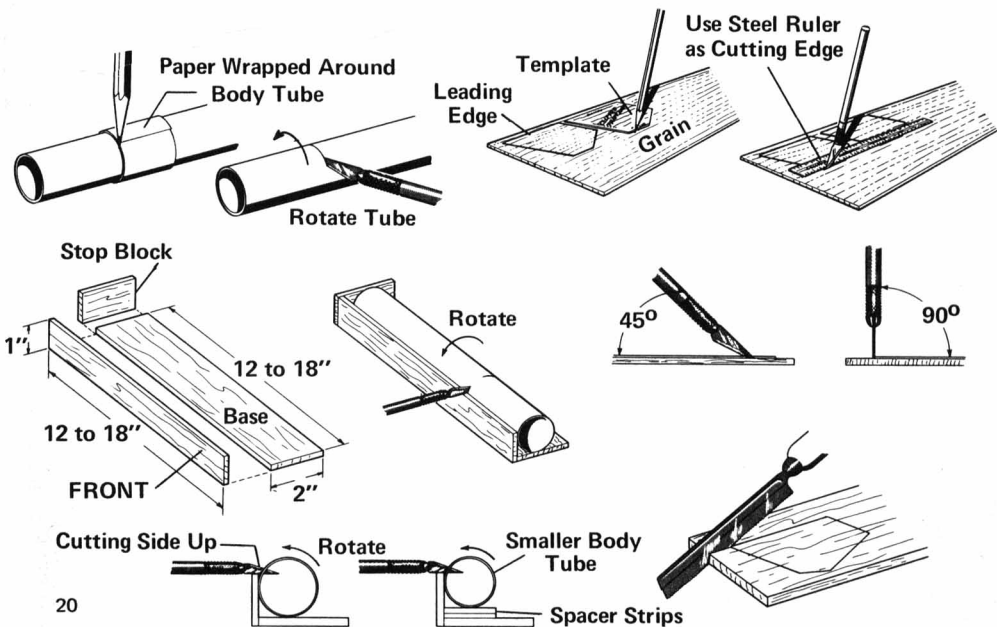

The fins must be sanded smooth before being attached to the rocket. Square up all edges with a sanding block. Lightly sand the surface of the fins and round the leading and trailing edges. If you wish to have a streamlined fin shape or if you are building a scale model with fins of a particular cross section, then sand to finished shape at this time. Chapter 7 deals with finishing and painting the rocket. The normal practice is to prepare the balsa fins for painting after they are attached to the rocket. If, however, you are using fins that have compound angles and special shapes, it would be more practical to completely "pre-finish" the fins before proceeding to the next step.

ATTACHING FINNS TO THE BODY:

The first step in attaching the fins is to mark the fin locations on the body tube. All Centuri kits come with fin location and alignment guides. When you build a kit, save these guides for future custom building use. As an alternative, use the body tube chart in Chapter 5 to mark the tube. To extend parallel lines along the tube, place the body tube against the lip of a drawer, a flat piece of wood or other material which has parallel sides and a thickness of approximately $\frac{1}{2}$ the body tube diameter.

For gluing the fins to the body, we highly recommend the use of Centuri Superbond. This glue is specially formulated and is the strongest glue available for this purpose. White glue takes longer to dry, but will work as a substitute. Model airplane type cements are NOT recommended for use on flying model rockets.

Pre-gluing will provide the strongest joints. It is done in the following manner: Sand the root edge of the fin to remove any filler material (if you pre-finished the fins). Run a light bead of Superbond along the root edge and on the pre-marked line on the body tube. Allow the glue to become almost dry. Run another bead of Superbond along the fin root edge and press in place on the body tube. Check the alignment of the fin with the alignment guide, or with the body tube guide in Chapter 5. (If the fins extend below the end of the body tube, the guide in Chapter 5 does not work very well. If you have an "accurate eye" you can 'sight align' the fin with reasonable results. When you are satisfied the fin is properly aligned, set aside to dry.

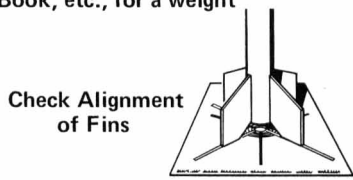
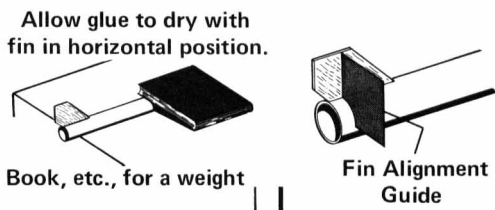
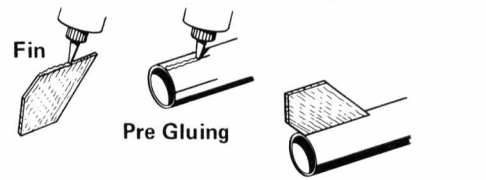
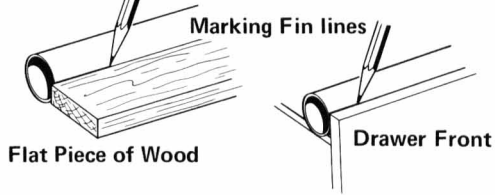
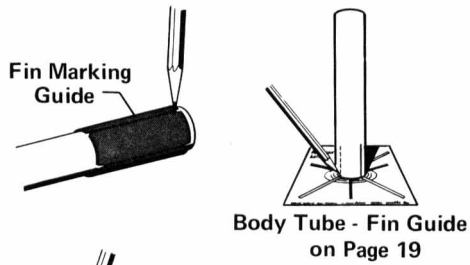
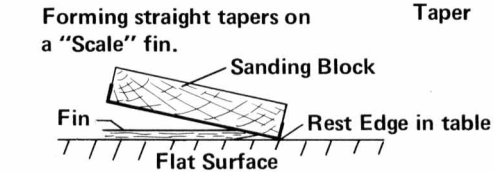
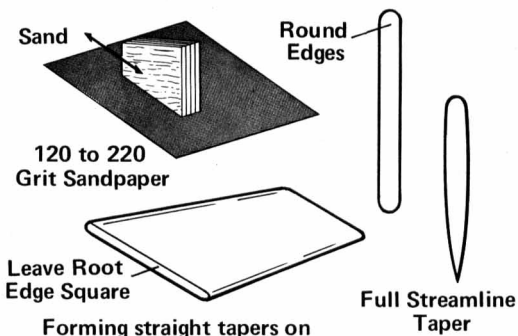

After the glue has thoroughly set, repeat this process with the remaining fins, one at a time.

The fin joints can be greatly strengthened by adding fillets of glue. This is to be done only after the original glue joints are completely dry. Run a bead of glue along both sides of each fin-body tube joint. Smooth the glue into even fillets with your finger. Set the rocket aside in a horizontal position and allow the glue to dry. Note: If you stand the rocket vertically, the fillets may sag and look unsightly.

INSTALLING ENGINE MOUNTS:

All Centuri custom engine mounts come complete with assembly instructions, so we will not go into that here. Just remember to glue the engine mount in securely; the thrust of the engine against the mount can produce considerable force. If you wish to add an engine lock to the mount, it is a very simple process. Concealed engine locks will normally work only on # 10 through 20 series body tubes. The # 8 series tube does not have enough clearance for the spring action of the lock to function. An engine lock can be installed on a rocket which is built from the # 7 series tube, but the engine lock will be exposed. The engine lock is secured by simply cutting a slit in the mount at the base of the thrust ring, inserting one end of the lock into the slit and securing in place with the mylar lock ring. (Centuri Engine Locks EL-1 include mylar lock rings.) It will be necessary to cut clearance slots in the engine mounts as shown. If you wish to use an engine lock on a # 7 tube rocket, it must be installed BEFORE the fins are attached.

The engine mount is normally positioned with the aft end of the mount even with the aft end of the body. In some instances, especially with larger body tubes, you may wish to recess the mount into the body for a short distance to provide an added stability margin. (See Chapter 3.)

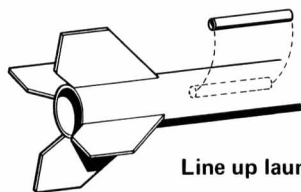

Line up launch lug with body

ATTACHING THE LAUNCH LUG:

In the case of a straight single diameter rocket, the launch lug is simply glued right to the body tube. The lug should be attached at the approximate CG of the rocket. After the lug is positioned on the body, sight along the launch lug to insure it is parallel with the body tube. Once the glue is dry, you may wish to run a small fillet of glue along the launch lug-body joint for added strength. (See Illustration Page 23.)

Freshly glued fin in upright position

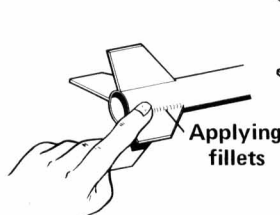
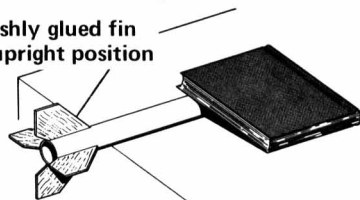

Applying fillets

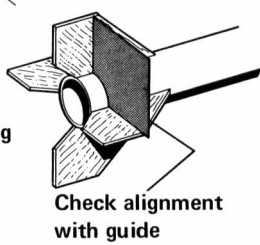

Check alignment with guide



1/8"

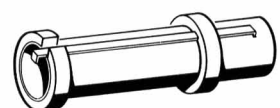

Adapting an engine lock to an EM-10A engine mount

Adapting an engine lock to an EM-13, 16, 20 engine mount

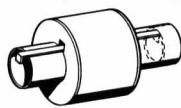

Cut slot in this ring.

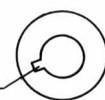

Mylar Lock Ring

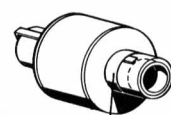

Adapting an engine lock to a # 7 body tube (Exposed)

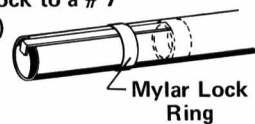

Mylar Lock Ring

If the rocket has an enlarged payload capsule, the launch lug must be mounted on a balsa "stand-off". The stand-off must be wide enough so the launching rod will not rub against the payload section. If a rocket is quite long, it may require two launch lugs. These are glued in place near the top and bottom of the rocket body. Use a launching rod to align the lugs and keep them in alignment while the glue is drying.

SHOCK CORD AND PARACHUTE ATTACHMENT:

By far the best and easiest way to attach a shock cord to your rocket is by using Centuri's Shock Cord Fasteners, Cat. No. SCF-1. These fasteners are very strong; they are heat resistant and have a permanent pressure sensitive backing. To install, simply remove the backing material, loop the shock cord through the holes as shown, and press the Fastener in place inside the body tube. Make sure the Fastener is far enough inside the body tube to clear the nose cone base when it is set in place on the rocket. The shock cord is secured to a balsa nose cone by means of a screw eye. The screw eye is inserted into the base of the cone and turned until it is seated all the way into the balsa. The screw eye is then removed, glue is squirted into the hole and the screw eye is replaced. This insures permanent anchoring against ejection shock. This shock cord is tied to the screw eye in a firm, triple knot. Smear a little glue on the knot to prevent it from loosening. With Centuri plastic nose cones, an attachment lug is cast into the base. Simply tie and glue shock cord to attachment lug.

Parachutes may be attached in two ways: The shroud lines may be tied to the screw eye or nose cone lug, or they may be tied to the eye of a snap swivel. The snap swivel can then be attached to the nose cone. The snap swivel not only keeps the shroud lines from becoming tangled, but allows quick interchange of parachutes from different models.

FITTING NOSE CONES AND PAYLOAD CAPSULES

Nose cone and payload capsule bases should be checked to insure a perfect fit. The bases should fit snugly but not tightly into the body tube. A tight fit may cause malfunction of the recovery system. A fit that is extremely loose may allow the cone to come off during the thrusting phase. If the fit is too tight, a little

sanding will take care of the problem. If the fit is too loose, wrap a turn or two of tape around the base. In the case of payload capsules, all fits except the one that sockets into the body tube must be tight to prevent the capsule from coming apart during the "snap back" of the shock cord.

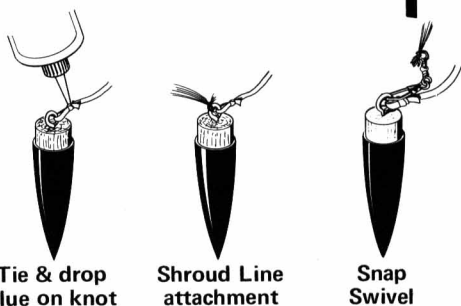
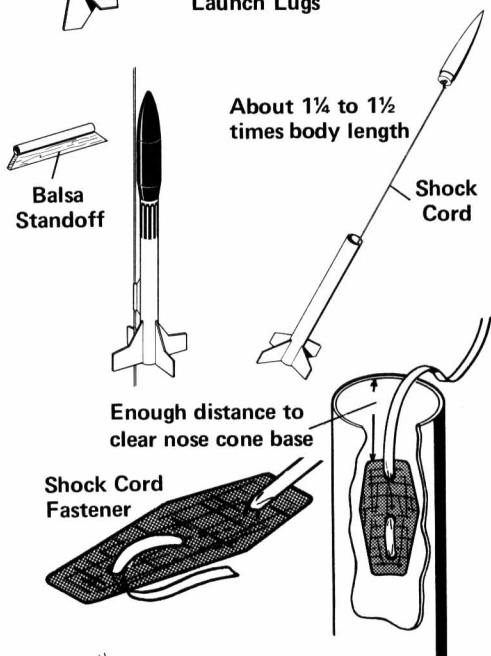
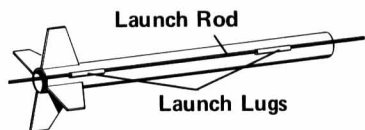

Snug but not tight

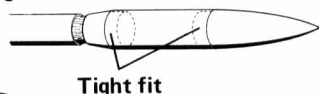

Tight fit



Tape if fit is too loose

Chapter 7: Finishing the Rocket

In order to have a smooth finished appearance after having been painted, balsa wood must be filled and sanded before painting. The following steps are absolutely necessary if you wish to have a really good looking model. Since you have sanded the fins to shape prior to attachment to the body, it is only necessary to lightly sand the surface with very fine sandpaper. Next, the fins are painted with a special filler preparation (Centuri Fil-Cote). This preparation fills the grain lines in the balsa and dries hard in 30 minutes. Apply two coats of filler at intervals of 15 minutes. After 30-45 minutes have elapsed, sand the fins with medium fine sandpaper. After sanding, apply another coat of filler, let dry and sand lightly to a smooth glassy finish. If the balsa is very porous it may be necessary to apply more filler to obtain the desired finish. If you are using a balsa nose cone, it must be prepared in the same manner as the fins.

Centuri body tubes need no preparation and should not be sanded. They have a polyglassine coating which is very smooth yet accepts all types of paint easily. The choice of paint is up to the model builder. Model airplane dope will work well. It brushes easily and dries hard in 15 to 20 minutes. Enamel is usually thicker and heavier and takes much longer to dry. It is generally, however, more durable than dope. A word of caution: Do not paint any plastic parts with dope or lacquer base paints. Chemicals in these paints will cause the plastic to soften, wrinkle, and in some cases, actually melt. Use only enamels on plastic parts. In painting with dope or enamel use a good quality flat brush. Run the brush strokes in one direction and do not go back over an area which has just been painted. Figure at least three coats of dope to produce a good finish, two coats of enamel. Allow the paint to dry between each coat. A faster and better way to finish a model involves the use of spray paint which comes in aerosol cans. Spray paint produces a very smooth finish, but must be done correctly to avoid runs and sags. Before spraying, you will need to build something

on which to stand the rocket during painting. A very simple holder can be made by gluing two expended engine casings end to end and gluing these to a wooden base. The rocket is slipped onto the top engine case and is held firmly in place in an upright position. Select a clean well ventilated area in which to paint. Spray the model with even passes of the can. Do not start or stop spraying when the spray is directly on the model. Spray a light mist coat and STOP — Allow the paint to dry. This is of the greatest importance. Do not try to finish the painting in one spraying. Chances are 10 to 1 you will ruin the finish. The first mist coat will leave the model with a lightly colored appearance. After this coat dries, another mist coat is sprayed on. After the second mist coat dries, the model is ready for final spraying.

First coat of fil-cote



Balsa

2nd coat of fil-cote



After sanding



3rd coat of fil-cote



After final sanding

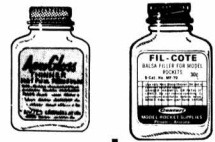

OR

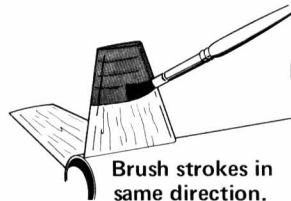

Painting Stand

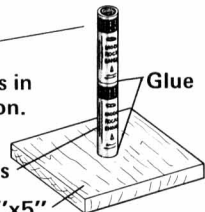

Expended Engine Casings

Wood Base 5"x5"

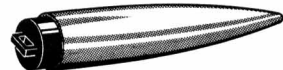

NOTE: Plastic nose cones do not have to be painted. Vigorous rubbing with a soft cloth will produce a hi-gloss finish to the pre-colored plastic.

The third coat is known as a "wet coat" and requires more care in application. Move the spray can up and down in slower arcs, allowing a heavier coating of paint to be applied. This heavy coat will have a wet glossy appearance. Care must be taken not to deposit too much paint in one area or runs will result. Once the wet coat has been applied to the model, allow it to dry for 3 to 4 hours before handling. If you did the job right, the paint should dry with a glass-smooth, hi-gloss finish.

If the model is to be a two color job, it will have to be masked before application of the second color. The model should be allowed to dry for at least 24 hours before any masking is done. Otherwise, the paint may pull loose when the masking tape to a model, press it against a piece of glass. This will remove some of the adhesive and reduce the possibility of lifting the paint. The masking tape should be applied carefully to the areas where the color change will occur. Large areas should be covered with paper which is carefully taped in place. Be sure there are no breaks or open seams in the paper through which the second color might sift and cause an overspray condition.

After all painting is completed, the model is ready for decals or trimming (using colored tape designed for that purpose). In applying decals, follow application instructions printed on the back of the decal sheet. Be sure to press all air bubbles from the surface of the decal and remove any excess water by gently blotting. Trim tape is quite easy to apply. Since it has an adhesive backing, just apply the tape to the model and cut off where desired. To preserve the finish and to prevent possible loosening of decals or trim tape, it is advisable to give the completed model a coat of clear spray paint. This should be done only after the decals are thoroughly set and all water has evaporated from the surface. Clear spray paint sometimes takes longer to dry than colors, so it is a good idea to let the model dry overnight before handling.

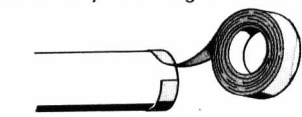
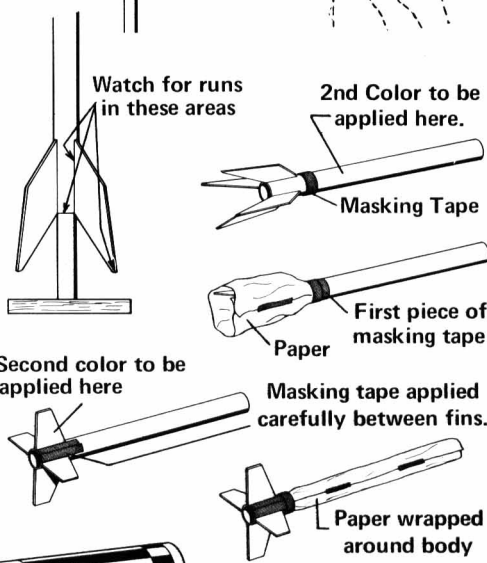
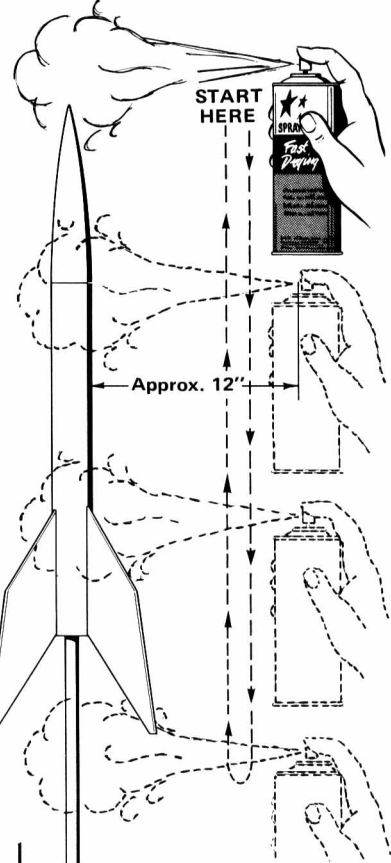

Applying trim tape.
(Centuri Pro-Stripe Tape)

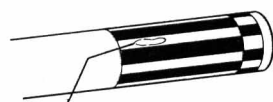

Remove all air bubbles by gently pressing them to the decal edge with a soft cloth.

Chapter 8: Multi-Staging

TYPICAL THREE STAGE CONSTRUCTION EMPLOYING CENTURI'S "PASS-PORT" STAGING SYSTEM*

This system utilizes specially constructed rockets which feature "break-away" booster stages. Engines are fitted into the stages and coupled to form a "stack". Special booster engines, having no delay or ejection charge, are used. The firing of a typical three stage rocket would work as follows: The engines are inserted into the stages and held in place by friction fitting with tape. Notice that the top or sustainer stage contains a regular delay-ejection type engine. With all engines in place, the stages are coupled together and an igniter is attached to the first stage engine. The rocket is set on the pad and the electrical leads connected. Upon ignition, the rocket lifts off with the thrust of the first stage engine. When this engine "burns through", bits of hot fuel are retro-fired up into the nozzle of the second stage engine, causing it to ignite. When the second stage engine begins to thrust, it pushes the first stage away. The first stage with its large fins tumbles safely to earth. When the second stage reaches burnout, it auto-ignites the third stage. The second stage is ejected and recovered in the same manner as the first stage. The third stage behaves as a single stage rocket, thrusting for a time then coasting to apogee where the recovery system is ejected for normal parachute recovery.

Multi-staging is an excellent way to attain high altitudes with a model. The number of stages possible is limited only by the available boost power of the first stage engine (the first stage engine must be able to lift the weight of all the stages and their engines). Four stages is probably the maximum and this would require extreme care in design and construction. For best results, booster stages must be kept to no more than 3" in length. Large fins are required for adequate stability and to slow the "tumble" speed during recovery. Stage coupling is important and Centuri's Pass-Port Staging System* is a must for effective auto-ignition. Best all round results are obtained from rockets using a # 10 series body tube. One feature of multi-stage rockets (especially 3 staggers) is the tendency to "weathercock". Because of the large amount of fin area, the rocket tends to be over-stable. When flown in a breeze, this over-stable condition causes the rocket to turn into the wind. The harder the wind, the more the tendency to "weathercock". For this reason, it is advisable to fly multi-stagers only in calm weather.

TYPICAL THREE STAGE MODEL

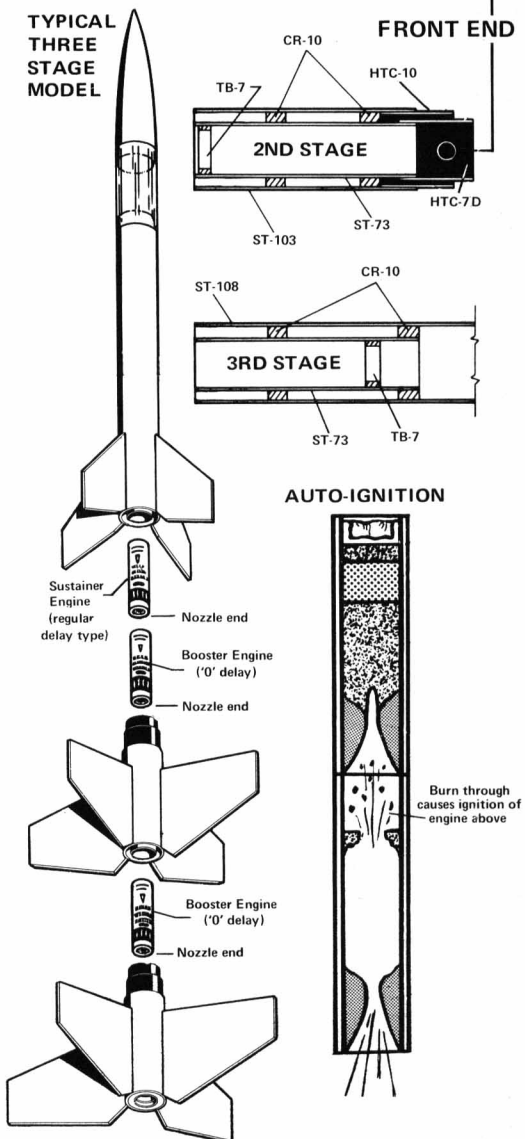

*Patent Application pending. Any individual who wishes to construct an assembly incorporating the invention covered by this pending application and any patent which issues thereon on a non-profit, non-commercial basis is hereby granted a royalty-free, non-exclusive license to practice this invention. Such license is not granted to persons or firms which practice this invention or induce the practice of this invention for profit or on a commercial basis.

Chapter 9: Large Scale Model Rocketry

Large Scale model rockets are termed those which are powered by the E and F class of Mini-Max and Enerjet engines. Because of the size of the engines, rockets in this category are rather large and heavy. In comparison, the Centuri Saturn V is larger than many of the "Large Scale" rockets, but is designed to fly primarily with the C-D type engines. It is, therefore, not considered to be a "Large Scale" rocket. Rockets in this advanced category are high performance types and must be constructed to take much higher thrust levels than the regular line of Centuri rockets.

ENGINES:

Mini-Max E and F engines are constructed like the standard line of rocket engines. 1-1/8" in diameter and 4-3/4" (E) or 7-3/4" (F) in length, they feature a wound paper casing, ceramic nozzle and a propellant, delay, ejection system very similar to the 1/2A through C engines. These engines range up to a maximum thrust level of 39 pounds as compared to 7 pounds maximum thrust in the standard engine categories. From this you can see why this is called "advanced" model rocketry.

Enerjet E and F engines are constructed of a new type propellant which is bonded into a filament wound, epoxy impregnated casing. The expansion nozzle and delay charge housing are machined from graphite. While these engines do not have as high of a maximum thrust peak as the Mini-Max engines, they burn for a much longer time at a high average thrust level, providing them with the highest total impulse figure of any engine in the model rocket field. Enerjet engines are of the same diameter but are shorter than the corresponding Mini-Max engines. They may be flown interchangeably in the large-scale rockets by simply inserting an adapter into the engine mount. Like the Mini-Max engines, Enerjet E and F engines are intended to be used only by the advanced, knowledgeable rocket enthusiast.

ROCKETS:

Large scale rockets differ in construction from the standard rocket line. Body tubes are heavier, most have a .040 wall thickness. Engine mounts are more heavily built to take the greatly increased thrust. The fins are of heavier balsa and are strengthened with reinforcing material to prevent their being stripped from the body during initial thrust.

The shock cord system consists of a steel cable in addition to the elastic shock cord. The nose cone must fit precisely into the body and the finish must be smooth. Fins, too, must be carefully sanded to a streamline shape. Recovery parachutes are made from mylar or silk. Proper materials and construction methods are absolutely necessary in this advanced field of "Large Scale" Rocketry.

TYPICAL ENGINE MOUNT SHOWING ADAPTER FOR ENERJET

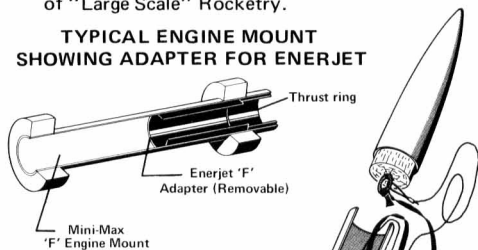

TYPICAL LARGE SCALE ROCKET CONSTRUCTION

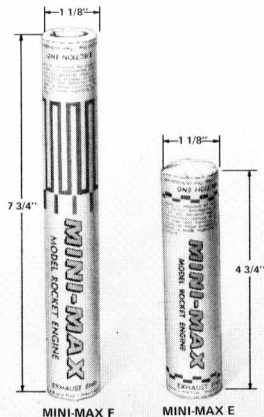
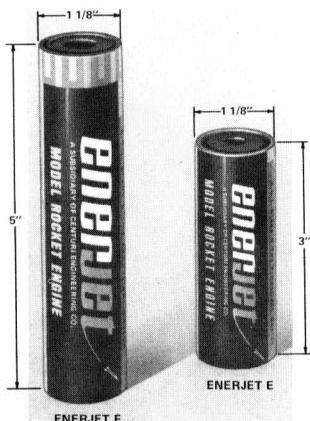
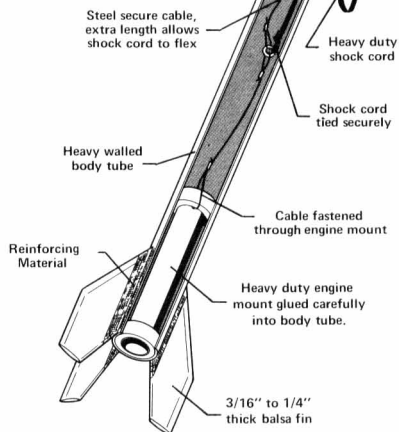

Chapter 10: 4 Model Rockets You can build

THE BUG

Flyweight Model

PARTS LIST

- | | |
|---------|--------------------------|
| 1 ST-73 | Body Tube—cut to 2" long |
| 1 BFM-8 | Balsa Fin Material |
| 1 LL-2 | Launch Lug |
| 1 BC-70 | Nose Cone |

Use paint and decals of your choice

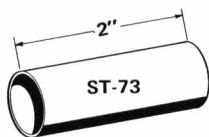

- 1** Cut body tube to 2" long.

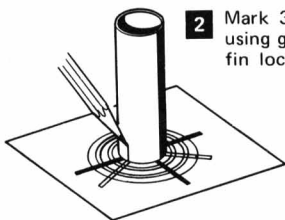

- 2** Mark 3 fin locations on body using guide on Page 19. Extend fin location lines along body.

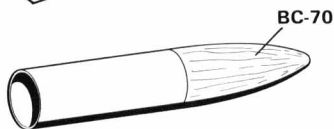

- 3** Glue nose cone into body.

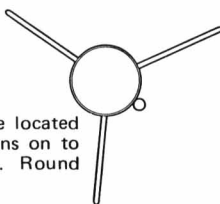

- 4** Using the appropriate fin template located on back cover, transfer fin patterns on to balsa. Cut out and sand to shape. Round all edges except root edge.

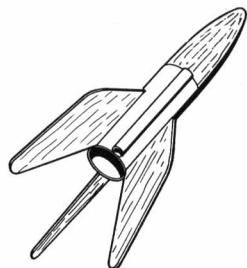

- 5** Attach fins and launch lug.

- 6** Finish balsa parts, paint and apply decal, if desired.

The following rocket designs demonstrate the use of components, designs, and construction techniques described in this booklet.

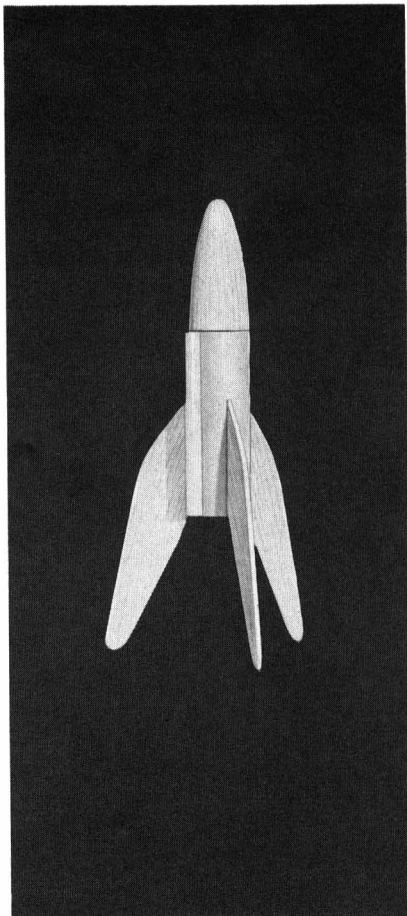

Fly the BUG with the following "short" engines:

$\frac{1}{2}$ A6-2S $\frac{1}{2}$ A6-4S

The step-by-step assembly instructions are to be coordinated with the general construction techniques described in detail in Chapter 6 (Construction Techniques).

ACHILLES

Pseudo Scale Model

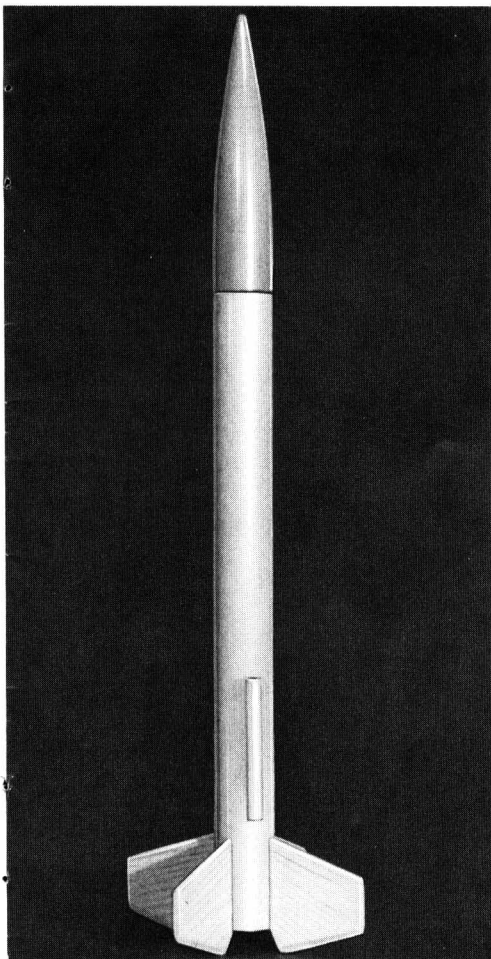

PARTS LIST

- | | |
|----------|------------------------------|
| 1 ST-712 | Body Tube—need piece 8" long |
| 1 TR-7 | Thrust Ring |
| 1 EL-1 | Engine Lock (optional) |
| 1 LRR-77 | Mylar Lock Ring (optional) |
| 1 PNC-76 | Nose Cone |
| 1 BFM-10 | Balsa Fin Sheet |
| 1 SC-18 | Shock Cord |
| 1 SCF-1 | Shock Cord Fastener |
| 1 RS-20 | Streamer |
| 1 LL-2 | Launch Lug |

Use paint and decals of your choice.

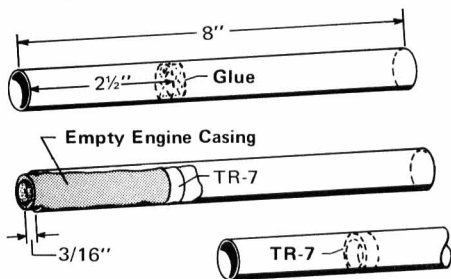

- 1 Cut body tube 8" long. Apply glue to inside of tube at 2-1/2" depth. Using an empty engine casing, push the thrust ring down into the tube until the engine casing is extended 3/16". Remove casing immediately.

- 2 Place 4 fin location marks on body tube by using guide on Page 19.

- 3 Mark appropriate fin pattern on the balsa sheet by using the ACHILLES fin template located on back cover.

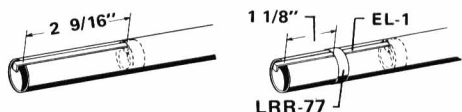

- 4 (OPTIONAL) Cut a short slit in the body tube at the base of the thrust ring. Insert one end of engine lock into slit. Glue the mylar lock ring over engine lock and body at the appropriate distance.

- 7 Sand and finish fins. Paint and apply decals to model.

Fly the ACHILLES with the following engines:

1/2 A6-4	B4-6	B14-6
A8-5	B6-6	C6-7

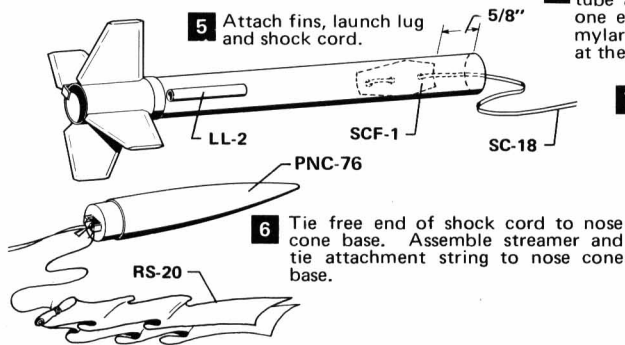

- 5 Attach fins, launch lug and shock cord.

- 6 Tie free end of shock cord to nose cone base. Assemble streamer and tie attachment string to nose cone base.

PAY DIRT

Payload Carrier

PARTS LIST

1 ST-1010	10" Body Tube
1 EM-10	Engine Mount
1 EL-1	Engine Lock
1 LL-2	Launch Lug
1 BFM-10	Balsa Fin Material
1 BTC-10	Balsa Tube Coupler
1 PNC-106	Nose Cone
1 CPT-103	Payload Tube
1 CP-20	Parachute
1 SC-18	Shock Cord
1 SCF-1	Shock Cord Fastener
1 SE-12	Screw Eye

Use paint and decals of your choice

- 1** Glue thrust ring into end of engine mounting tube.



Thrust Ring

- 2** Assemble engine mount with modification for engine lock as shown at right.

Cut 1/8" segment from bottom ring.

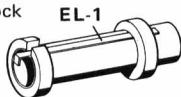

- 3** Mark 4 fin locations on an ST-1010 pre-cut tube. Refer to Design #1 for illustration.

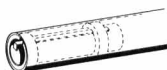

- 4** Glue engine mount into body tube as illustrated.

- 5** Using appropriate fin template located on back cover, mark fins on balsa sheet as shown.

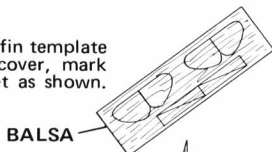

BALSA

- 6** Glue the 2 fin pieces together to form completed fin. Check alignment against straight edge.

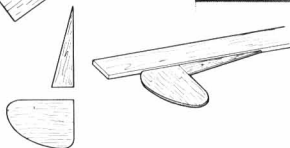

- 7** Glue fins to body. Attach launch lug and shock cord.

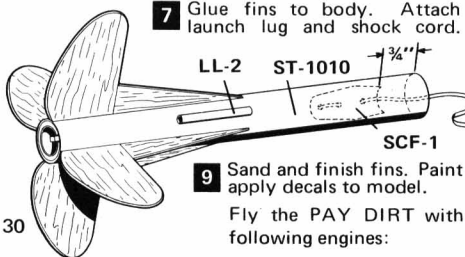

- 9** Sand and finish fins. Paint and apply decals to model.

Fly the PAY DIRT with the following engines:

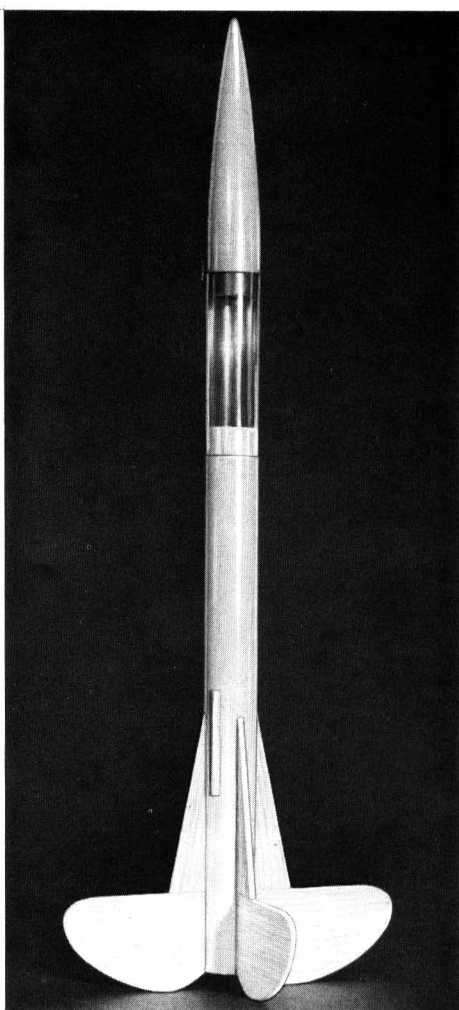

- 8** Socket tube coupler, payload capsule, and nose cone together. Attach screw eye and the free end of shock cord to the base of tube coupler. Assemble parachute and tie shroud lines to screw eye.

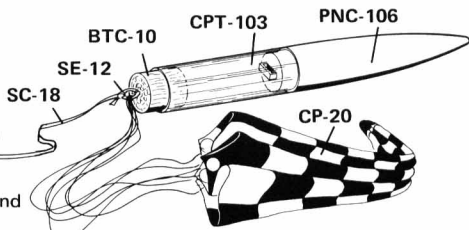

A8-3 B6-4 B14-5 C6-5

CLOUD BUSTER

Sports Rocket

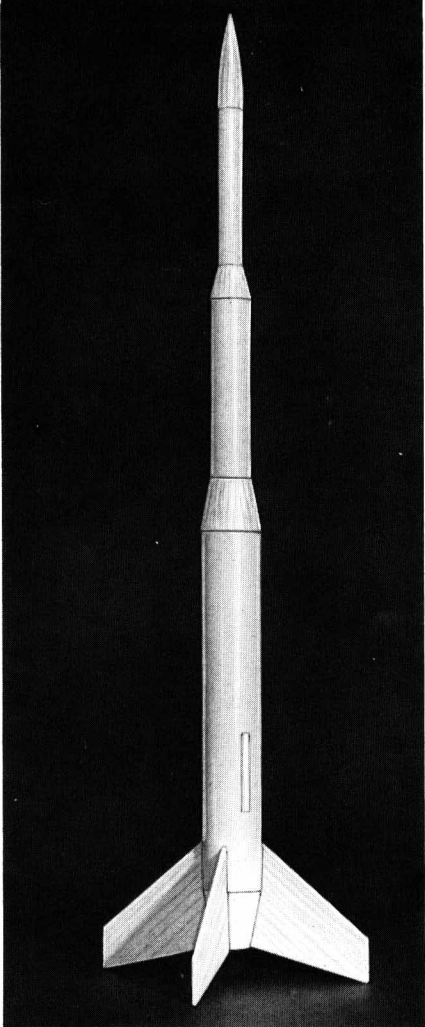

PARTS LIST

1 ST-138	Body Tube
1 ST-812	Body Tube—need piece 4" long
1 ST-512	Body Tube—need piece 3½" long
1 EB-13	Ejection Baffle
1 PR-713	Paper Reducer
1 SCF-1	Shock Cord Fastener
1 BFM-10	Balsa Fin Material
1 CP-20	Parachute
1 BC-54	Nose Cone
1 BR-8-13	Balsa Reducer
1 BR-5-8	Balsa Reducer
1 LL-2	Launch Lug
1 SE-12	Screw Eye
1 ST-73	Engine Mounting Tube
1 TR-7	Thrust Ring
1 SC-18	Shock Cord

Use paint and decals of your choice

- 1** Assemble the two segments of the paper reducer (PR-7-13).



- 2** Glue thrust ring into end of engine mounting tube.

Thrust Ring



- 3** Glue engine tube into the sleeve mount of the PR-7-13.

3/16"



- 4** Glue paper reducer over exposed portion of tube.

- 5** Use ST-138 or cut 8" body tube from ST-1318. Mark 4 fin locations using guide on Page 19.

- 6** Glue engine mount into body tube. Draw fin location lines on body and boat tail.



Reducer Seam

- 7** Assemble Ejection Baffle and glue into body tube.

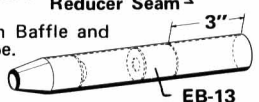

BFM-10

LL-2

SCF-1

SC-18

SE-12

BR-8-13

ST-8

BR-5-8

EB-13

3½"

ST-5

BC-54

CP-20

- 9** Attach fins, launch lug and shock cord.

- 11** Finish balsa parts, paint and apply decals.

Fly the CLOUD BUSTER with the following engines:

A5-2 B4-4 B6-4 B14-5 C6-5

- 10** Cut # 5 and # 8 body tubes to length, socket tubes and reducers together to form upper body. Attach screw eye to BR-8-13. Assemble parachute. Attach chute shroud lines and free end of shock cord to screw eye.

FULL SIZE FIN TEMPLATES for Rockets shown on pages 28-31

Lay a piece of tracing paper over the desired fin design and carefully trace outline with a pencil. Glue the tracing paper to a piece of light cardboard and cut out with scissors to form template. REMEMBER: When transferring fin design to the balsa, make sure the template is positioned in proper relationship to the grain of the wood.

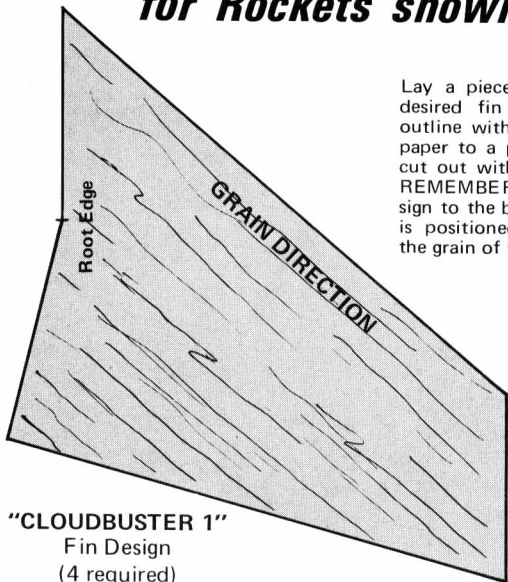

"CLOUDBUSTER 1"
Fin Design
(4 required)



"PAY DIRT"
Fin Design (A)
(4 required)

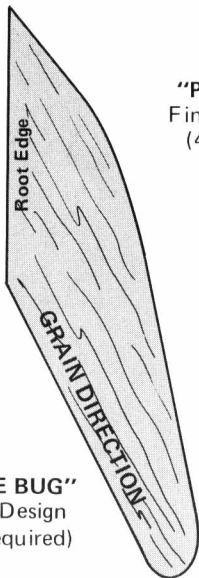

"PAY DIRT"
Fin Design (B)
(4 required)

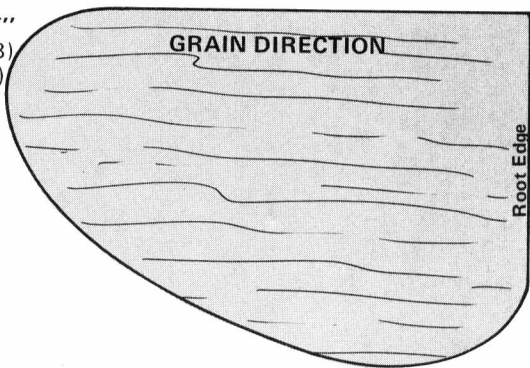

"THE BUG"
Fin Design
(3 required)

"ACHILLES"
Fin Design
(4 required)

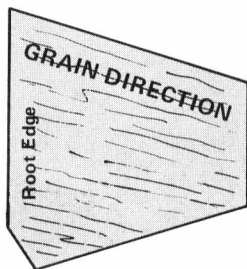

Although custom parts are available for purchase from Centuri to construct various model rockets, it is not necessary to purchase any unpatented parts from Centuri in order to acquire any license under any of Centuri's patent rights.