

Centuri Model Rocket

\$1.00

Design Manual

2nd EDITION: TOTALLY REVISED & EXPANDED

By Grant Boyd

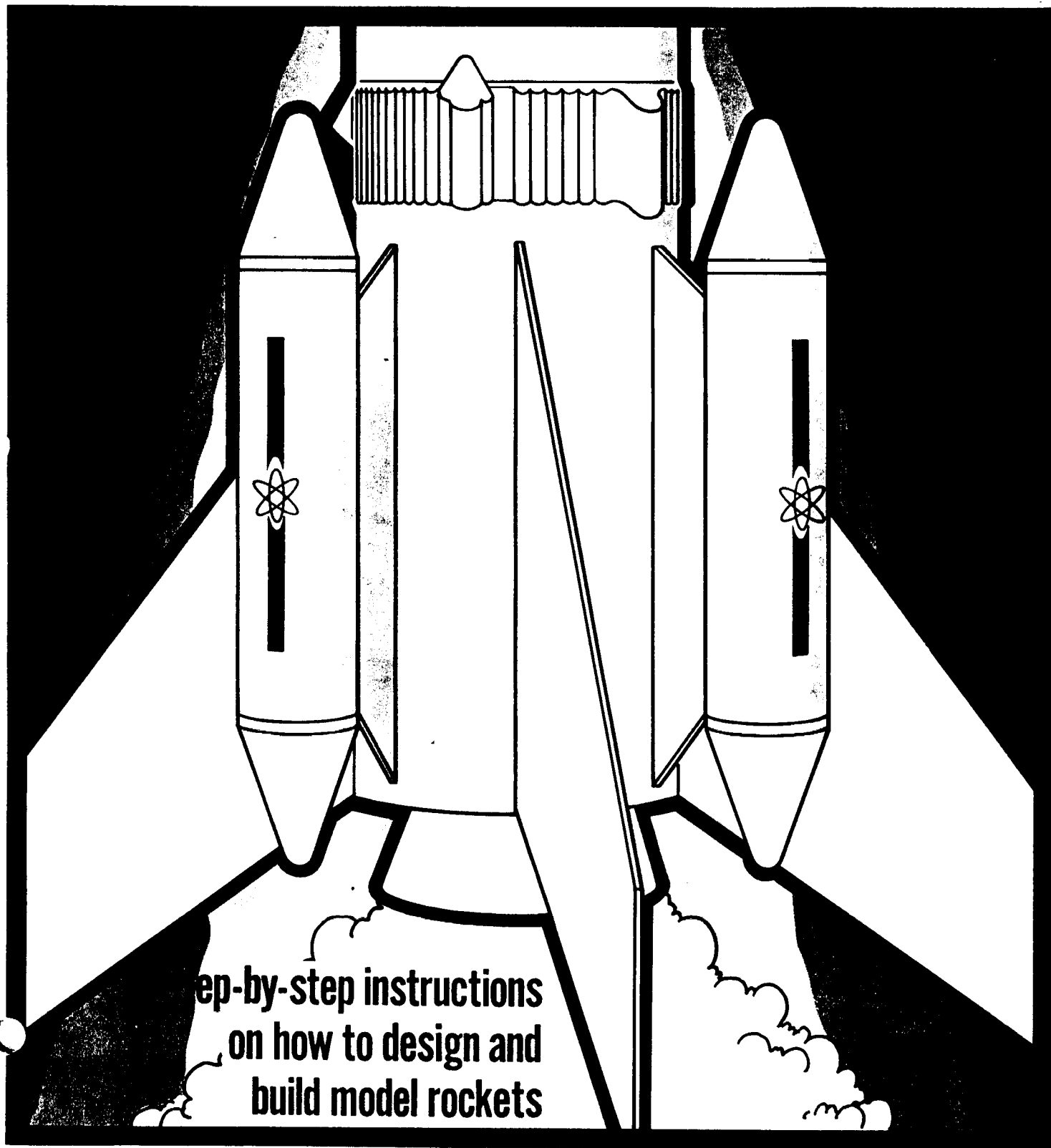



Table of Contents

Preface

Before You Start

In writing this manual we have to assume you already know quite a bit about model rockets . . . or you wouldn't be ready to design your own. We will not go into a lot of the basics; how rockets fly, parts of an engine, etc. These subjects are covered in the Centuri catalog and other basic publications.

Many rocketeers think that designing rockets is easy . . . "Why I just scribble out a design and then I'll slap it together!" Not so; especially if you want satisfactory results. The best way to go about it is to simply imagine you are a real rocket engineer. Here's what we mean:

1. RESEARCH: Study all the model rocket literature you can get your hands on. Start by reading this manual completely, before you design even a simple rocket.
2. CONCEPT: Decide beforehand what you want your design to accomplish: High altitude? Payload carrier? Does it require clustered engines? What kind of recovery system? Is it within your budget? Is it really practical, or does it only look good on paper?
3. PREPARATION: A very important word . . . Do you have the right tools on hand? Are you going to need a full-size drawing to be sure the parts fit properly? Do you have enough skill and knowledge to actually build this particular design?

We have divided this manual into several sections, in order of importance. The single most important subject, STABILITY, is near the front and must be understood before proceeding.

*Written by Grant Boyd
with acknowledgements to:
Bob Del Principe,
Keith Niskern,
G. Harry Stine.*

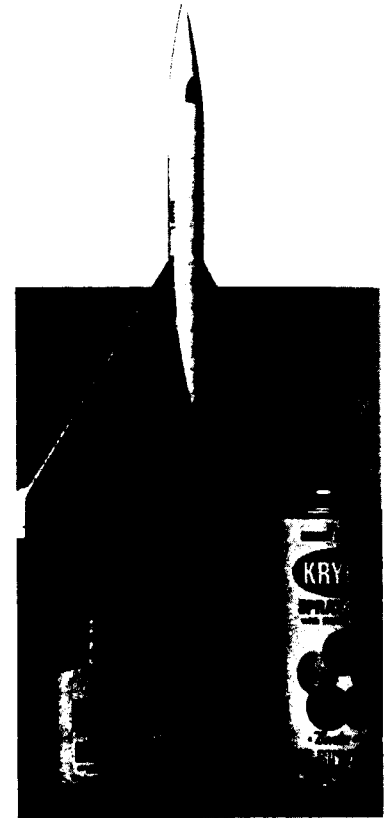

Contents

Preface	2
Safety	3
Basic Design	
Stability	4
Performance	6
Types	7
Components	8
Custom Parts	9
Construction	
Tools	10
Techniques	11
Finishing	14
Parachutes	15
Real Birds	16
Projects	
Altitude	18
Payloads	19
Staging	20
Gliding	22
Clusters	24
Scale	25
Ideas	
Two Plans	26
Styling	28
Materials	29
Displays	30
Odds & Ends	31

Model Rocketry: Safety



Safety Code

- 1. CONSTRUCTION**— My model rockets will be made of lightweight materials such as paper, wood, plastic, and rubber, without any metal as structural parts.
- 2. ENGINES**— I will use only pre-loaded factory made model rocket engines in the manner recommended by the manufacturer. I will not change in any way nor attempt to reload these engines.
- 3. RECOVERY**— I will always use a recovery system in my model rockets that will return them safely to the ground so that they may be flown again.
- 4. WEIGHT LIMITS**— My model rocket will weigh no more than 453 grams (16 ozs.) at lift-off, and the engines will contain no more than 133 grams (4 ozs.) of propellant.
- 5. STABILITY**— I will check the stability of my model rocket before its first flight, except when launching models of already proven stability.
- 6. LAUNCHING SYSTEM**— The system I use to launch my model rockets must be remotely-controlled and electrically operated and will contain a switch that will turn to "off" when released. I will remain at least 10 feet from any rocket that is being launched.
- 7. LAUNCH SAFETY**— I will not let anyone approach a model rocket on a launcher until I have made sure that either the safety interlock key has been removed or the battery has been disconnected from my launcher.
- 8. FLYING CONDITIONS**— I will not launch my model rockets in high winds, near buildings, power lines, tall trees, low flying aircraft or under any conditions which might be dangerous to people or property.
- 9. LAUNCH AREA**— My model rockets will always be launched from a cleared area free of any easy to burn materials, and I will only use non-flammable recovery wadding in my rockets.
- 10. JET DEFLECTOR**— My launcher will have a jet deflector device to prevent the engine exhaust from hitting the ground directly.
- 11. LAUNCH ROD**— To prevent accidental eye injury I will always place the launcher so the end of the rod is above eye level or cap the end of the rod with my hand when approaching it. I will never place my head or body over the launching rod. When my launcher is not in use I will always store it so that the launch rod is not in an upright position.
- 12. POWER LINES**— I will never attempt to recover my rocket from a power line or other dangerous places.
- 13. LAUNCH TARGETS & ANGLES**— I will not launch rockets so their flight path will carry them against targets on the ground, and will never use an explosive warhead, nor a payload that is intended to be flammable. My launching device will always be pointed within 30 degrees of vertical.
- 14. PRE-LAUNCH TEST**— When conducting research activities with unproven designs or methods, I will when possible determine their reliability through pre-launch tests. I will conduct launchings of unproven designs in complete isolation from persons not participating in the actual launching.

This safety code is endorsed by:
The National Association of Rocketry
The National Fire Protection Association
The Hobby Industries Association of America
and All Model Rocket Manufacturers



Throughout the past twelve years, over 25 million model rocket launchings have been made — most of them by young men 10 to 17 years of age . . . and establishing one of the best safety records of any youth activity. Why such an excellent record? Well, here are four good reasons.

FIRST, the rocket engines are self contained in non-metallic casings — no mixing of chemicals. Engine reliability and performance are tested continually at the factory.

SECOND, the rocket itself is constructed of strong, but extremely lightweight materials such as balsa, paper, and plastic. And, the rockets contain recovery systems which bring them slowly and safely back down to earth, to be readied for another flight.

THIRD, the engines are ignited electrically using special igniters and safety firing switches. No matches or fuses are used.

FOURTH, and most important, is the attitude of the model rocketeers. They look upon this hobby as being exciting and educational. They don't think of rockets as toys. Hundreds of thousands of rocketeers have promoted the safety of the hobby by following the Safety Code printed here. Read this code, follow it, and enjoy this exciting hobby.





Basic Design: Stability

INTRODUCTION

The word **STABILITY** in model rocketry means the ability of the rocket to travel in a relatively straight direction, without tumbling and twisting. This is a very important concept to understand before designing your own rockets. Once in flight, a model rocket is no longer under your direct control . . . its ability to follow a pre-determined flight path rests solely on how well the rocket is designed and constructed.

Model rockets are intended to thrust in a vertical (or near vertical) flight path, against the pull of gravity. They are not flown horizontally like airplanes, because they do not have the required wings, airfoils, or moveable control surfaces for achieving lift.

Imagine a model rocket flying through still air. The air is passing smoothly over the model (see Figure A). As long as it isn't disturbed, the rocket will fly straight into the air flow. This is its neutral position.

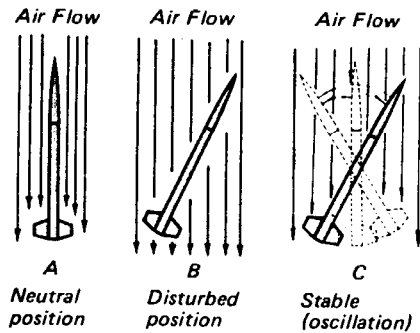

If the rocket is disturbed say by a wind gust, thrust misalignment, or cocked fin, then it will fly at an angle-of-attack (Figure B). A stable model rocket will then make continual corrections during its flight as it attempts to return to zero (Figure C) just as a person manually makes constant corrections to maintain a straight path when driving a car or riding a bicycle. But, if it starts to fly at wider and wider angles to the air flow and eventually flips end-over-end in the air, it is unstable (Figure D). If the rocket is neutrally stable, it will continue to fly at an angle to the air flow, no matter what the angle is (Figure E).

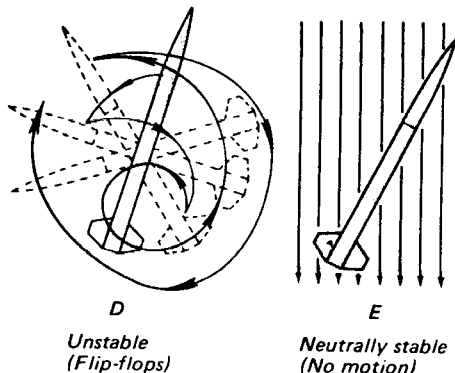

What you would see while watching from the ground is shown here.

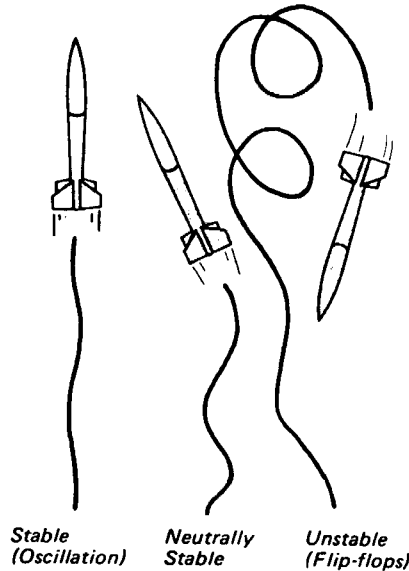

There are two primary factors which influence the flight stability of a model rocket: Center of Gravity and Center of Pressure. In order for a model rocket to fly stably the center of gravity must be ahead of the center of pressure. Always remember this rule in designing your model rockets.

CENTER OF GRAVITY

The center of gravity is quite easy to determine. Simply balance the rocket (with a live engine in place, chute wadding, etc. installed) on a ruler or thin piece of wood. The point at which the rocket balances is the center of gravity. Abbreviated CG.

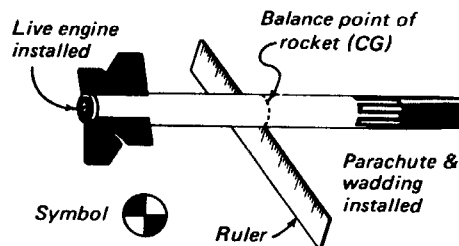

CENTER OF PRESSURE

The center of pressure (CP) is more difficult to determine. The CP is similar to the center of gravity except that the forces involved are the air pressure forces acting on the rocket while it is flying. A formal definition is, "The center of pressure of a rocket is the point at which all the air pressure forces on the rocket seem to be concentrated". That is, there is as much air pressure force distributed on the rocket ahead of the center of pressure as there is behind it.

The approximate center of pressure may be found by making an exact size cutout of the rocket from cardboard. This cutout is balanced on the ruler to show the center of pressure (CP). Note: The formulas for determining the true CP of a rocket are discussed fully in Centuri's Technical Report TIR-33. In order for a rocket to have a reasonable stability margin, the CP should be at least one body diameter behind the CG.

(This rule-of-thumb applies only to this method of calculation of CP-CG.)

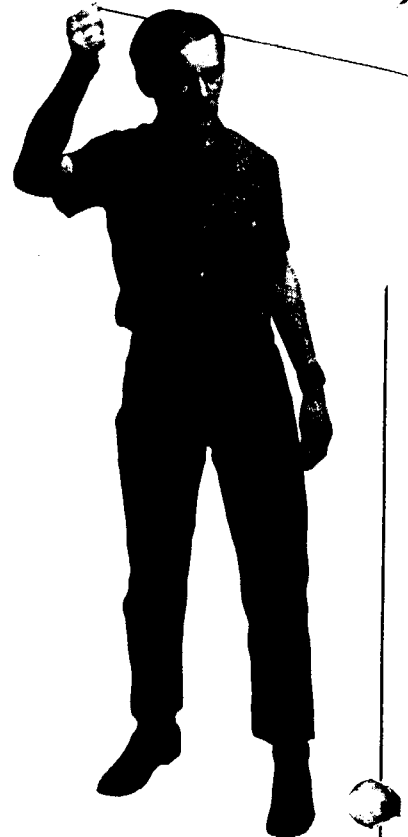
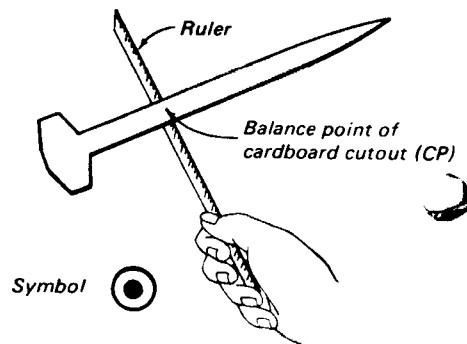

SWING TESTING

Prepare the rocket as you would for launching. Use the heaviest engine you would ever fly in the rocket. The rocket must be fully "flight prepped" with the exception of the igniter. Locate the balance point of the rocket (CG). Tie a loop in a 10 foot piece of cord and place around the rocket at the CG point. Tape the cord to the body so it will not slip forward or backward.

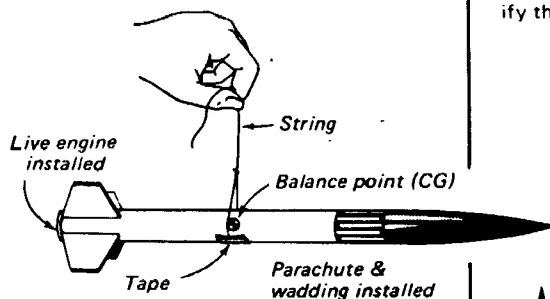

Hold the rocket at arms length, point the nose in the direction you will swing and begin to swing the rocket around your head. As the rocket picks up speed, let the cord out to about 8'. If the nose of the rocket points approximately in the direction you are swinging and stays pointed that way, the rocket will fly stably. If it twists, turns flat against the wind, or if the tail of the rocket turns forward, the rocket does not have sufficient stability.

The swing test can actually over-compensate for stability. Rockets that seem to almost pass the test, may be very stable in flight. Many Centuri kits do not quite "pass", yet all are very stable in flight. You must maintain a very high speed swing, to simulate the rapid flight of a model rocket. If the rocket is super-stable in the test you may have too much built in stability, resulting in severe "weathercocking".

Objects such as darts and archery arrows will fly in a stable path because the metal tip moves the CG forward, while the feather fins move the CP rearward. The same principle is used in model rockets. Looking at Centuri model rocket kits will give you a feel for how large fins should be to create a stable flight.

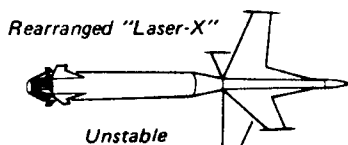
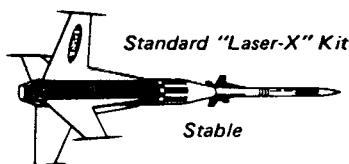

CORRECTING INSTABILITY

One way to correct instability is to move the CP to the rear. Enlarging the fins or extending them rearward will accomplish this. An easier method (especially if the rocket is completed) is to move the CG forward. This is done by adding weight to the nose of the rocket. After any alterations are made, the rocket must be re-tested to verify stability. Remember that the CG will change when you modify the rocket, so locate the CG before flying.

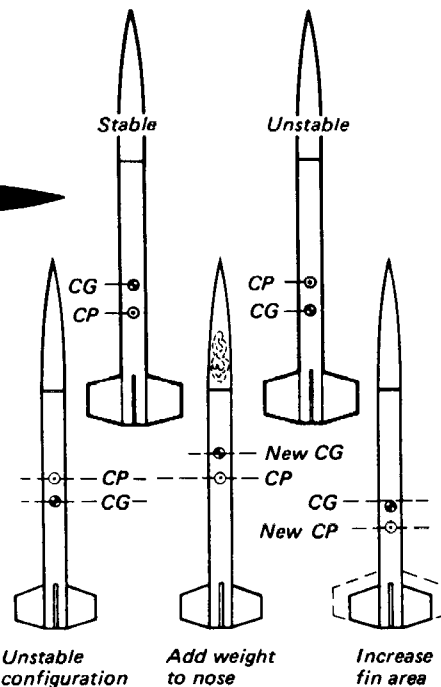

To advance the center of gravity on a rocket a wad of modeling clay can be pushed into the extreme end of the plastic nose cone, or washers can be held onto wooden cones with the screw eye.

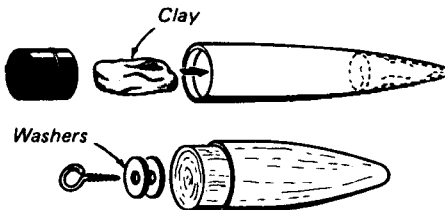

In some cases where a #13, #16, or #20 body tube is used, the engine mount can be recessed an inch or so into the body to help increase the stability margin. (Moving the engine and its mount forward moves the CG forward).

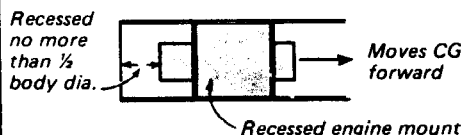

STABILIZATION

Here is one more way to improve stability . . . Add small tabs onto fins or cant the fins slightly to cause spinning around the central axis. This will improve the flight path of a marginally stable rocket, much like a bullet is spun by internal grooves in a rifle barrel.

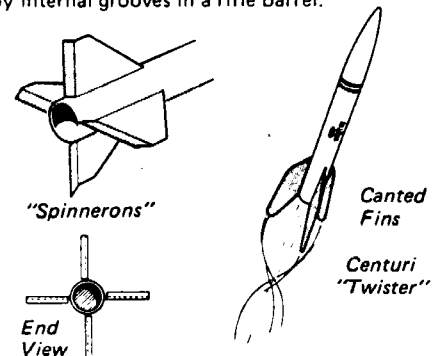

The spinnerons or canting of fins must be kept small and slight for best effect. The spinning technique has its drawbacks though. It uses up energy inefficiently and adds greatly to aerodynamic drag, thus decreasing altitude. Spinning may also cause tangled chute lines at ejection, but it is still an interesting technique.

TECHNICAL TERMS

Here are a few more advanced stability concepts. More can be learned from Centuri Tech Reports or general aerodynamics books at any good-sized library.

CALIBER

The caliber of a rocket is its diameter. A rocket possessing "one-caliber stability" has its CP one caliber behind the CG. Never try to fly a rocket with less than 1/2 caliber stability.

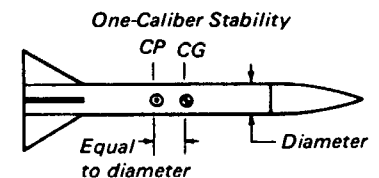

FINENESS RATIO

A long, slender rocket will fly better than a short, squat one. Here we get into "fineness ratio", or the ratio of length to diameter. A good fineness ratio figure to start with is 10 (Example: 1-inch-diameter rocket 10 inches long). A high fineness ratio requires less fin area, all other factors remaining the same.

$$\text{Fineness Ratio} = \frac{\text{Length}}{\text{Diameter}} \text{ or } R_f = \frac{L}{D}$$

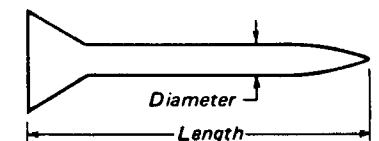



Basic Design: Performance

INTRODUCTION

After achieving a stable design, most rocketeers move on to improving its performance. It's a great thrill to know that your rocket flies maybe half again as high as someone else's, simply because you took steps to increase its performance.

Most factors affecting performance can be summed up in one word: DRAG. Aerodynamic drag is defined as the resistance created by a body moving through the air. There are several types of drag that influence the performance of a model rocket. Rather than go into a prolonged discussion of aerodynamic drag at this point, we'll just mention a few things you can do to reduce drag on your flying model rocket.

"FINE-TUNING" STABILITY

A rocket with only marginal stability will oscillate back and forth on its CG, as the fins continually correct for a poorly placed CG. This oscillation uses up a great deal of momentum and presents a broad surface area to the airstream, thus decreasing maximum altitude. Increasing the stability just a bit in this case may greatly increase performance.



LAMINAR FLOW

The airstream passes over a very simple rocket in a clean, unbroken movement. This laminar flow is "tripped", or broken, by any surface bumps thus adding to drag. Here are some of the causes of laminar flow drag:

Nose cone bigger (or smaller) than body tube

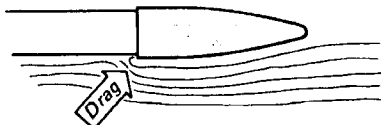

Lack of a reducer at body tube transition

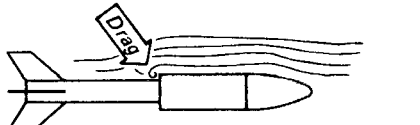

This works better:

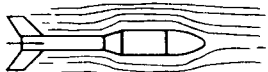

Here are some more "villains" of laminar flow:

- Unfinished balsa
- Frayed body tube seams
- Rough paint finish
- Thick decals or tape

NOSE CONES

Although tests show this is not as critical as was once thought, a parabolic shaped cone is the optimum shape for reducing drag on subsonic flight models.

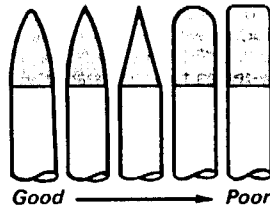

FINS

The shape of the fins has some effect on drag. A swept back fin with rounded corners will generally produce a little less drag than a fin with sharp corners.

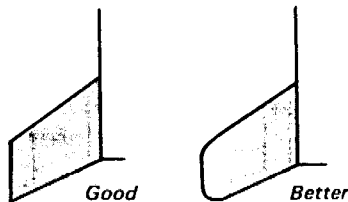

Of greater importance in reducing drag (especially in the case of a light weight rocket) is the cross section shape of the fin. A gently rounded leading edge and a tapered trailing edge on a fin will produce less drag than a fin on which all edges are square or just rounded. Drag is also produced in the area where the fins join the body tube. Fillets along the fin body joints will reduce this interference drag.

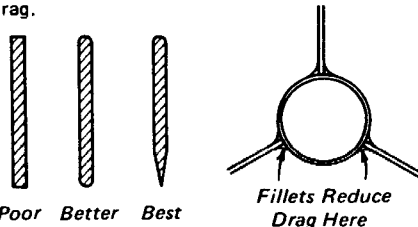

A rule of thumb in determining fin area is that each fin should be at least 1½ times (in both directions) the diameter of the body.

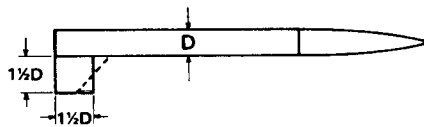

The span of a fin is more effective than its chord. By this, we mean that increasing how much it sticks into the airstream will do more for stability than will increasing its chord (or height).

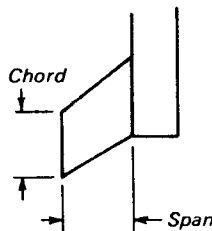

BOAT TAIL

Curving the rear portion of the rocket inward will reduce base drag at this point. This is of course, only possible on rockets that have an inside body diameter larger than that of a model rocket engine.

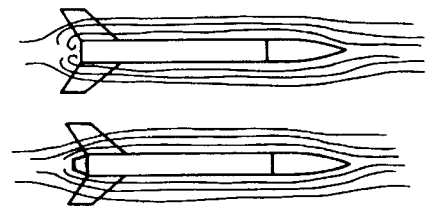

Many of the Centuri paper reducer kits may be used as boat tails. Instructions for cutting your own paper boat tails are on page 18.

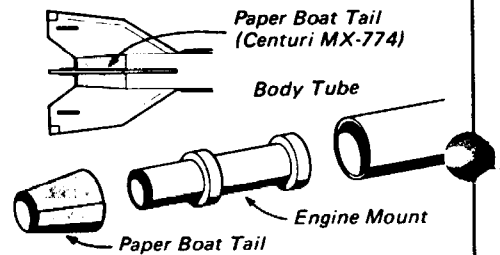

Balsa boat tails can achieve even smoother airflow. These are made from balsa nose cones.

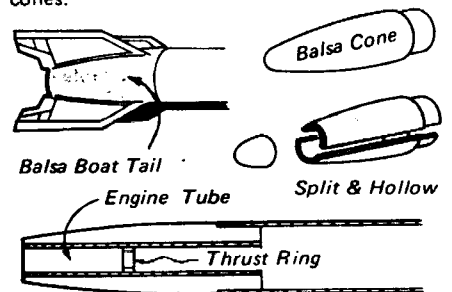

FRONTAL AREA

Always check to see how your proposed design will look from the front. Frontal area is defined as the amount of surface which faces directly into the airstream. Too much frontal area creates substantial air resistance, or drag.

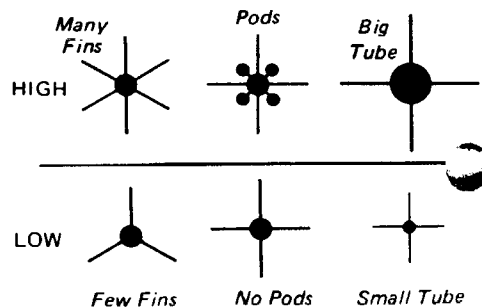

Basic Design: TYPES

RECOVERY SYSTEMS

The most common recovery system used on model rockets is the plastic parachute. Several other types of recovery systems are also used on certain rockets.

PARACHUTE

The parachute ejects, fills with air and lowers the rocket gently to the ground. Large rockets may use two or even three parachutes for recovery. See page 15 for more information.

STREAMER

A streamer is a long ribbon made from crepe paper or plastic. Upon ejection from the rocket, the tail of the streamer flutters in the breeze and slow the descent of the rocket. Streamers are normally used on light weight models under 2 oz. More information on page 15.

TUMBLING

A very lightweight, small rocket which falls gently back to earth. Engine ejects and changes CG-CP to allow tumbling.

BOOST GLIDE

All, or a portion of the model returns gently to earth by gliding. There are many ways of doing this, as explained on pages 22-23.

GYRO RECOVERY

The rocket is designed in such a manner that drag surfaces react with the airstream. These cause the rocket to spin and thus slow its descent.

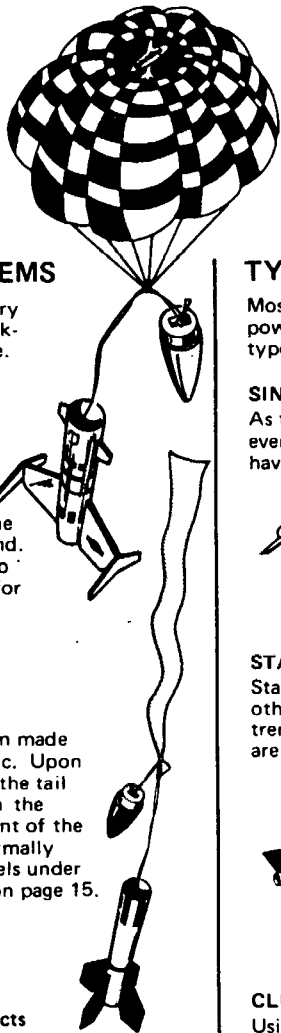

TYPES OF POWER

Most model rockets use standard single-engine power for the best reliability. There are other types; each with its purpose.

SINGLE-ENGINE

As the name implies, only one engine is used, even though it may give the appearance of having more than one.

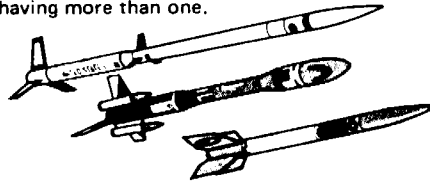

STAGED ENGINES

Stacking special engines one on top of another causes successive power boosts, for extreme altitudes. More facts on this technique are on page 20-21.

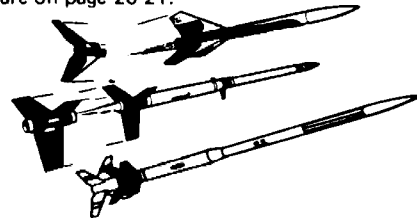

CLUSTERED ENGINES

Using two (or more) engines firing at the same time increases lift-off ability tremendously. Ideal for heavier models such as these scale NASA birds. More info. is on page 24.

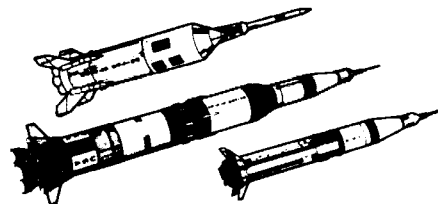

STANDARD ENGINES VS. MINI-MOTORS

The smaller cross-sectional size of a mini allows the rocket body to be narrower, thus decreasing frontal area and drag.

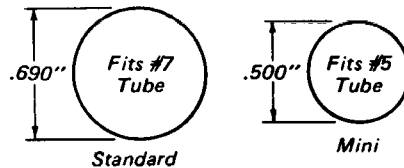

Mini-Motors weigh considerably less than a standard engine of the same power. This allows a rocket design to have its CG further forward, and improve stability.

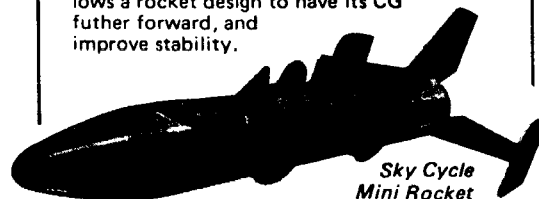

FUNCTIONAL TYPES

The vast majority of rocket flights are done simply for thrills and satisfaction. There are some specialized functions that many rocketeers move on to for more challenge.

SPORT

Just plain FUN! There are many exotic styles and building techniques to choose from.

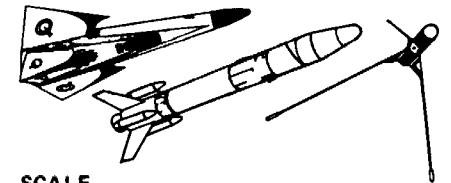

SCALE

Models of real rockets and missiles used by NASA, the Armed Forces, and private industry. Some are only semi-scale, while others are highly detailed and challenging.

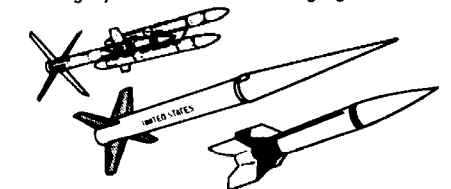

PSEUDO-SCALE

These look like scale models of real rockets, but are actually imaginary designs.

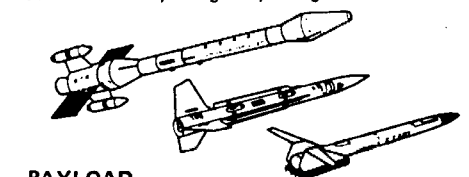

PAYLOAD

These have special compartments to carry insects for testing, or competition in weight-lifting contests.

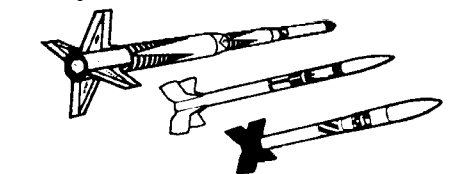

COMPETITION

Many rocketeers compete in very specialized flying contests, usually under the rules of the National Association for Rocketry. Centuri produces several kits which often win in their categories.

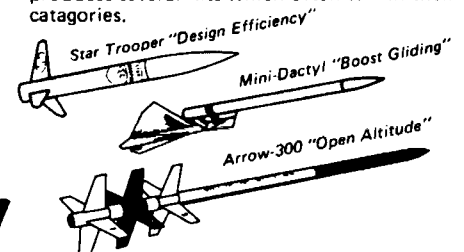



Basic Design: Components

FINS

Fins can be cut from a single piece of balsa or may be made up of two or more balsa sections. Remember that the grain line should always run parallel with the leading edge of the fin.

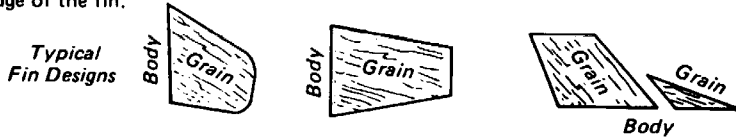

BODY TUBES

Centuri body tubes are made of a specially rolled, hi-strength kraft paper. The wall thickness is ideal for maximum strength with the lightest weight. Centuri body tubes are finished with a poly-glassine coating which produces a very smooth finish and provides a good bond for glue or paint. Body tubes are available in a variety of sizes (see Chapter 5). A #7 tube (.76" diameter) is the smallest tube in which a model engine will fit. Mini-motors will fit into a #5 (.50"). Clear plastic tubes are great for payload capsules and interesting design effects.

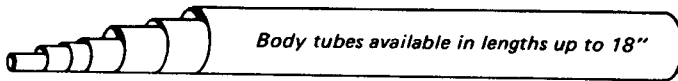

ENGINE MOUNTS

The simplest engine mount is a thrust ring glued into a #7 body tube. In larger body tubes, a 3" long #7 tube with thrust ring is used to hold the engine. This tube is centered in the larger tube with centering rings or a disc and coupler combination.

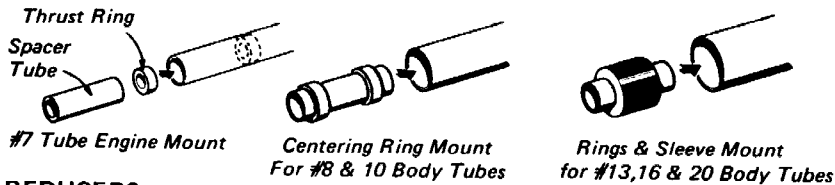

REDUCERS

These useful parts are great for varying the diameter of a rocket. The balsa ones are solid (to block ejection gases) while the paper and plastic are hollow (to allow gases to pass thru).

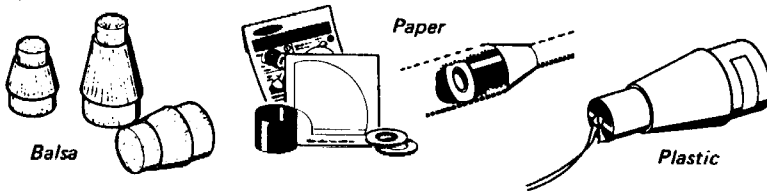

COUPLERS & CONNECTORS

The balsa connector or hollow paper tube coupler extends the length of a rocket. Like reducers, balsa connectors seal off a tube while paper couplers allow passage of gases.

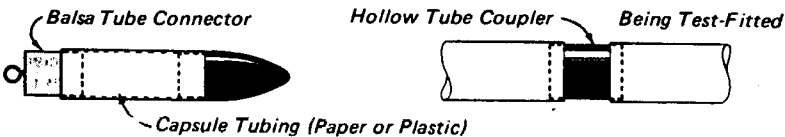

EJECTION BAFFLES

These are optional items for body tubes #13 and larger. Baffles trap and dissipate heat without reducing the "ejection pressure" of the gases. As a result, the parachute is protected from heat.

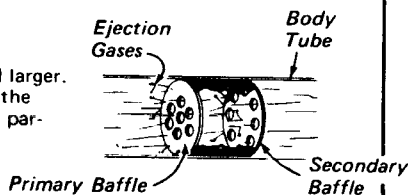

NOSE CONES

Like reducers, these are available in plastic and balsa. Plastic cones are popular because of their smooth regular surface requiring no sanding before painting.

OTHER PARTS

- LAUNCH LUGS for lift off control.
- ENGINE LOCKS for prepping convenience.
- SHOCK CORD to absorb ejection shock.
- SCREW EYE to attach cord to nose.
- FASTENER to attach cord to body.
- CHUTE OR STREAMER for recovery.

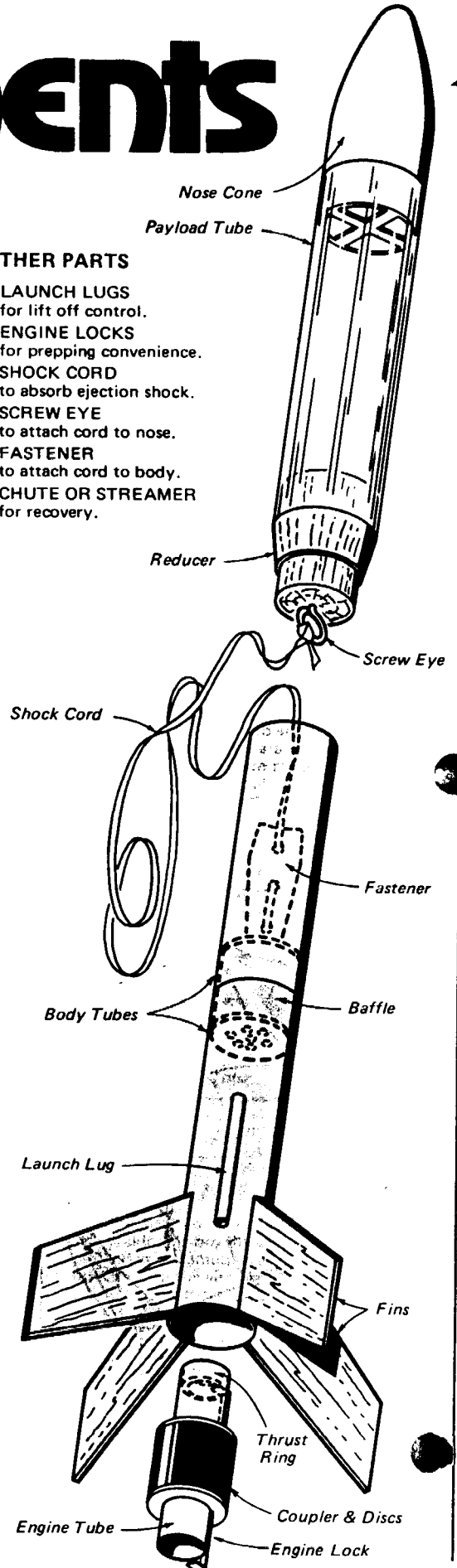

Basic Design: Custom Parts

Centuri model rocket parts are number coded in a very simple and logical system. An understanding of this system will enable you to design custom rockets with a minimum of effort.

Basic rocket components are all numbered according to the seven different series of Centuri body tubes. These series are based on the diameters of the various tubes produced.

All parts are numbered in a combination of a letter prefix followed by a 2 to 4 digit number. The first digit(s) provide identification of the specific part. The letter prefix gives a descriptive abbreviation of the part. Study the examples. They will clarify the system more fully.

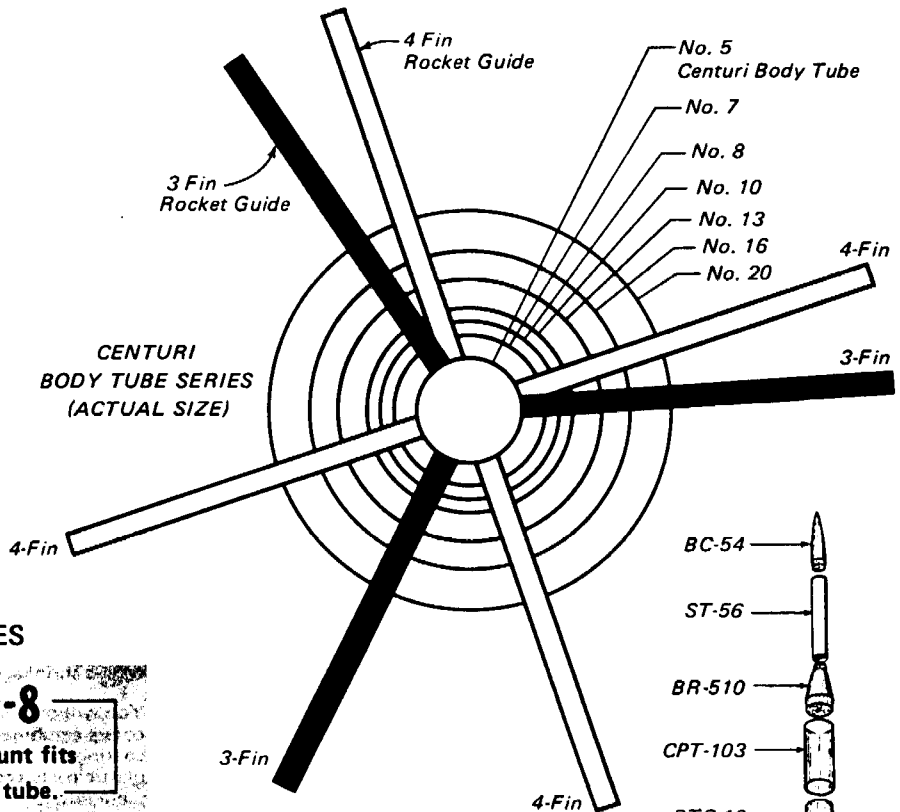

CENTURI PARTS NUMBER EXAMPLES

ST-712
Spiral Wound Body Tube
12" long
#7 series

EM-8
Engine Mount fits #8 series tube.

PNC-103
Plastic Nose Cone
3" long
#10 series

CPT-134
Clear Plastic tube
4" long
#13 series

PR-716
Paper Reducer
to #16 series tube
Adapts #7 series tube

BR-710
Balsa Reducer
to #10 series tube
Adapts #7 series tube

Series:	Nominal inside diameter of body tube:
#5	.5"
#7	.7"
#8	.8"
#10	1.0"
#13	1.3"
#16	1.6"
#20	2.0"

Body tubes are available in a variety of lengths. 12" and 18" lengths are, however, the most economical purchases. You can cut from these longer tubes the exact lengths that you need. The #7 series tube is a glove fit for a model rocket engine. The balsa and paper reducers can be used to combine the different series, offering an unlimited variety of possible rocket shapes. The example shown is somewhat exaggerated in design, but does demonstrate a variety of possible combinations.

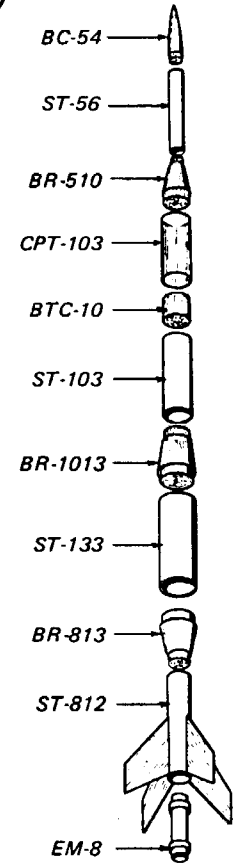

EXAMPLE ONLY TO SHOW POSSIBLE COMBINATION OF CENTURI PARTS
(Not a recommended design. No recovery system included).



Construction: Tools

INTRODUCTION

The tools needed to build model rockets are inexpensive, and once purchased, almost never wear out—they are a lifetime investment. Most of the tools and supplies explained here are available at hobby shops; many are also in Centuri's mail order catalog.

WORK AREA

Choose a practical assembly area: well lighted, big enough to work in, and out of the way of relatives or pets who might accidentally mess up your partially completed model.

A cutting board is a standard item to prevent marring of the table surface, and prolong the life of the knife blade. A piece of heavy solid (not corrugated) cardboard makes a good cutting board.

We use plate glass here in our R&D shops at Centuri. The glass is a little hard on knife points, but it is perfectly flat and smooth, cleans very easily, and will never wear out.

GLUE

The ideal glue is Centuri SUPER BOND or any other type of aliphatic-resin base glue such as Wilhold. This bonds very strongly, dries fast, and will not cause pieces to warp when laminated. A good second choice is "white" glue, such as Elmer's or Glu-Bird. Do NOT use model airplane cement for model rockets. It is not strong enough for rockets, nor does it allow for smooth enough fillets and joints.

Plastic model glue is often required for gluing molded nose cone parts together. Avoid prolonged breathing of its fumes and work in a well-ventilated area.



MODELING KNIFE

A modeling knife is a "must" item, for cutting fins and tubes, and countless other steps. Always handle the knife carefully. If you ever drop a modeling knife or if it rolls off the table, never-never try to catch it. This could produce a nasty cut on the hand.

The knife shown is the type preferred by most modelers; an X-acto # 1 handle with a # 11 blade. Similar types are made by American Safety Razor and Griffhold.

They use replaceable blades which should be discarded when they become dull. Some modelers use two knives; one is marked for precision work and kept sharp, while the other is reserved for rough cutting.



SCISSORS

Choose a small pair of at least medium quality...cheap ones wear out fast and don't cut neatly.

METAL RULER

A 6" or 12" metal ruler for measuring and cutting a straight edge is a necessary tool. Some modelers simply buy a very cheap carpenter's tri-square and discard the sliding metal square.

SANDPAPER

Sandpaper is required in a variety of grades. Sandpaper is graded by the "grit" or relative smoothness. Avoid the cheap "Garnet" type. A medium quality sandpaper costs only pennies more and will last far longer.

- 120 & 150 GRIT For rough shaping.
- 220 & 320 GRIT Between applications for fillercoat.
- 400 & 600 GRIT Used for final sanding.

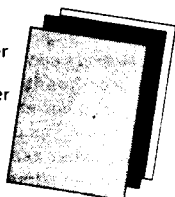

FILLER OR SEALER

You need some type of thick undercoating to smooth balsa surfaces before painting. Here is what we use at Centuri, in order of preference.

- HOBBY POXY "STUFF" (thin with MEK)
- CENTURI FIL-COTE or FILLERCOAT (Pactra, Testors; etc.)
- SANDING SEALER (Pactra, Testors, etc.)
- "HOMEMADE" (Talcum powder and thinner)

Model airplane dope-thinner or lacquer thinner is used to change consistency and clean brushes. Most of the fillers are lacquer, yet you can apply enamel over them if the filler is thoroughly dry.

BRUSHES

A 1/4" or 1/2" brush is needed for applying filler. Narrower brushes are used for painting detail. Choose at least a medium quality to avoid the hairs pulling out and sticking to your paint.

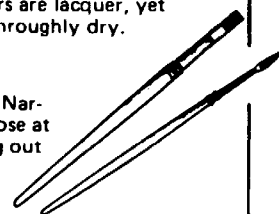

PAINTS

Select your paints wisely. Many rocketeers use brush-on dope or enamel due to the low cost per bottle. This approach only SEEMS to be cheaper. Spray paints in aerosol cans are actually more economical in the long run, and produce a much better appearance. A lacquerized-enamel (such as Krylon) is ideal because it dries smoother and lighter than enamel—yet it can be applied over plastic too. Spray enamel is a good second choice and is readily available. Spray dope is very smooth, but causes shrinkage, and can't be used on plastic.

You will probably use more cans of white than all other colors combined. It is very opaque and provides undercoating for other colors. Spray primer is handy for plastic parts and cutting down on balsa-filling. Complete info. on painting is on page 14.



OPTIONAL TOOLS

Here are some items you will rarely need, but they are handy for certain applications...

- EPOXY GLUE— for tricky bonds, such as metal to plastic.
- CONTACT CEMENT— for gluing plastic directly to paper or balsa.
- TWEEZERS— for placing small parts.
- RAZOR SAW— for cutting thick balsa.
- SANDING BLOCK— for accurate smoothing of sheet balsa.

Ready made:

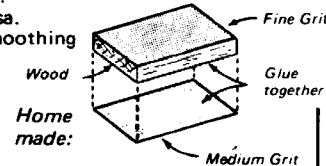

TUBING CUTTER—Make the jig from any available wood to the approximate dimensions shown. To use, place the body tube in the jig, position the knife, blade up on the edge of the jig at the desired cut off point. Rotate the tube slowly, keeping the knife point pressed against it. Make the cut gradually, with several revolutions instead of only one. To cut different diameters of tubes, modify the jig by placing flat pieces of wood on the base plate to serve as spacers for small tubes.

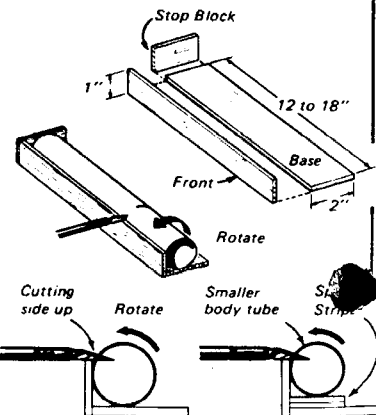

You will also need common household items such as tape, pencils, and rags for cleaning.

Construction: Techniques

CUTTING BODY TUBES

There are several ways to do this neatly. The best way is to build a cutting jig as shown on page 10. Another quick technique is explained here.

Wrap a piece of paper around the tube where the cut is to be made. Place a pencil against the edge of the paper and draw a line around the tube. Lay the tube on a flat surface and rotate slowly, cutting along the pencil line with a sharp knife. Use light pressure and do not try to cut through the tube on the first pass. Larger diameter tubes may need a coupler placed inside to prevent collapsing while cutting. Once the tube is cut, dress down the end by sanding on a flat piece of sandpaper.

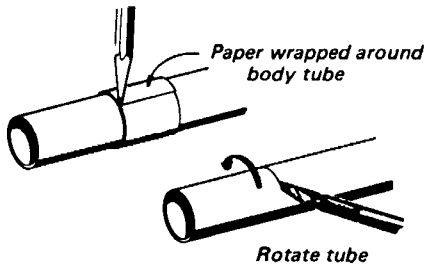

MAKING FINNS

Once a fin shape has been decided upon, a card stock template must be made. Using a soft lead pencil, trace the outline of the template onto a balsa sheet. Remember—the leading edge (top) of the fin should always be parallel with the grain of the balsa.

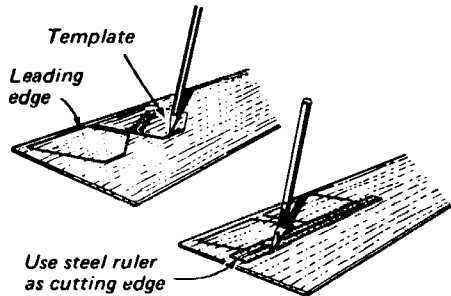

Balsa is soft and easy to cut, but a few basic rules must be followed to produce consistently good results. Always use a metal straight edge as a cutting guide and always use a sharp knife. When cutting out fins, place the straight edge so the knife blade cuts to the outside of the fin. If the knife slips, you will only nick the scrap balsa, not the fin. Hold the knife straight and cut in several light passes. This results in a neater cut with less dulling of the blade. Hold the knife as shown for best results.



If you are cutting very heavy balsa, a razor saw is better than a knife. Razor saws have a very thin blade and very small teeth, making them perfect for this type of work.

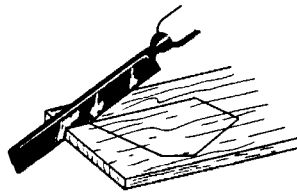

The fins should be sanded smooth before being attached to the rocket. Square up all edges with a sanding block. Lightly sand the surface of the fins and round the leading and trailing edges. If you wish to have a streamlined fin shape or if you are building a scale model with fins of a particular cross section, then sand to finished shape at this time.

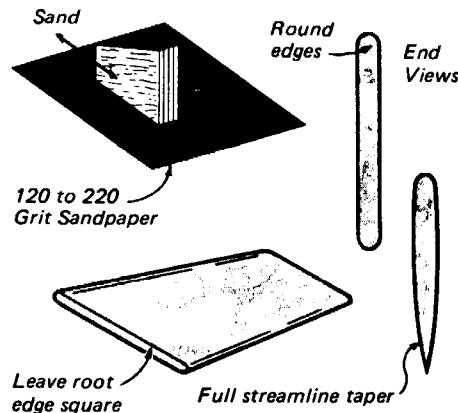

The normal practice is to prepare the balsa fins for painting after they are attached to the rocket. If, however, you are using fins that have compound angles and special shapes, it would be more practical to completely "pre-finish" the fins before proceeding.

Forming straight tapers on a "Scale" fin.

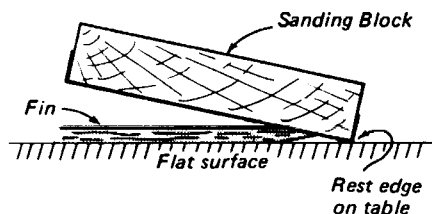

FIN POSITIONING

The first step in attaching the fins is to mark the fin locations on the body tube. All Centuri kits come with fin location and alignment guides. Use the body tube chart on page 9 to mark fin positions on the tube.

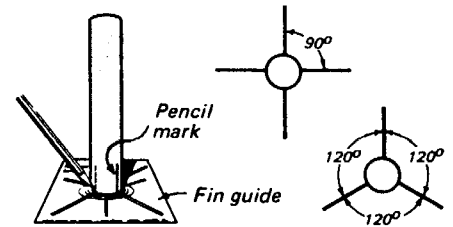

To extend parallel lines along the tube, place the body tube against a door jamb, the lip of a drawer, a flat piece of wood or other material which has parallel sides and a thickness of approximately 1/2 the body tube diameter.

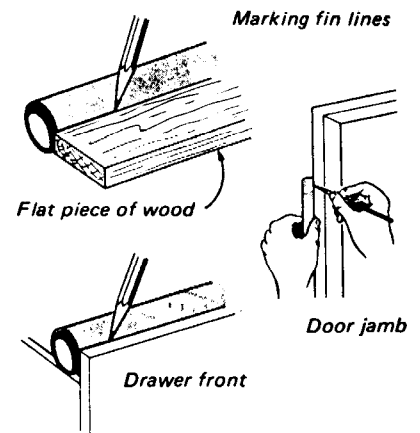

FIN ATTACHMENT

Pre-gluing will provide the strongest joints. It is done in the following manner: Sand the root edge of the fin to remove any filler material (if you pre-finished the fins). Run a light bead of glue along the root edge and position the fin on its pre-marked line on the body tube; holding it a few seconds.

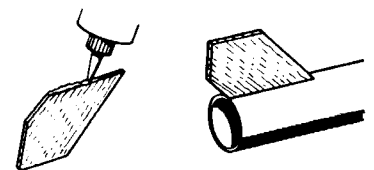

Remove the fin and allow the glue to become almost dry. Run another bead of Superbond along the fin root edge and press in place on the body tube, aligning carefully.

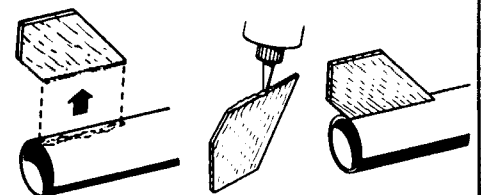



Construction: Techniques

Check the alignment of the fin with the body tube guide on page 9. (If the fins extend below the end of the body tube, the guide does not work very well. If you have an "accurate eye" you can 'sight align' the fin with reasonable results). When you are satisfied the fin is properly aligned, set aside to dry a little before further handling.

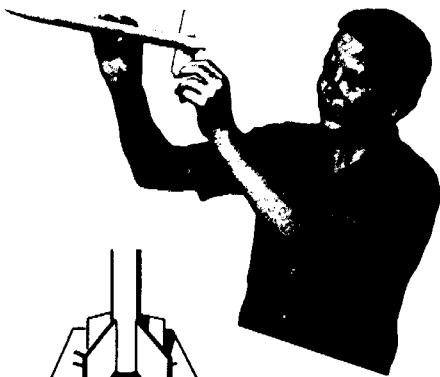

Check alignment of fins

Allow glue to dry with fin in horizontal position

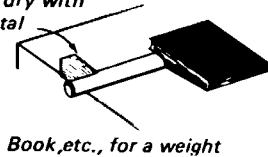

Book, etc., for a weight

After the glue has thoroughly set, repeat this process with the remaining fins, one at a time.

The fin joints can be greatly strengthened by adding fillets of glue. This is to be done only after the original glue joints are completely dry. Run a bead of glue along both sides of each fin-body tube joint. Smooth the glue into even fillets with your finger. Set the rocket aside in a horizontal position and allow the glue to dry. Note: If you stand the rocket vertically, the fillets may sag.

Freshly glued fin in upright position

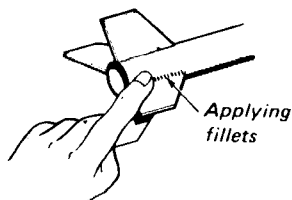
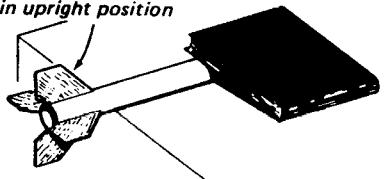

Applying fillets

ENGINE MOUNTS

All Centuri custom engine mounts come complete with assembly instructions, so we will not go into that here. Just remember to glue the engine mount in securely; the thrust of the engine against the mount can produce considerable force. If you wish to add an engine lock to the mount, it is a very simple process. Concealed engine locks will normally work only on # 10 through 20 series tubes.

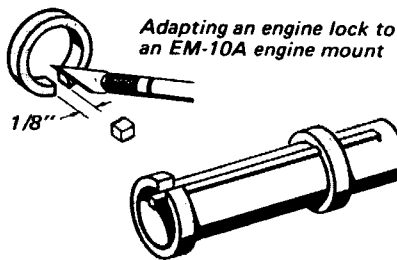

Adapting an engine lock to an EM-10A engine mount

Adapting an engine lock to an EM-13, 16, 20 engine mount

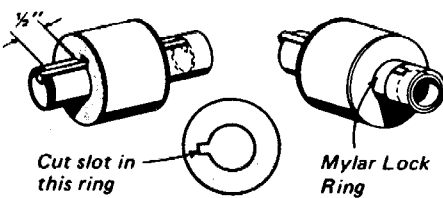

Cut slot in this ring

Mylar Lock Ring

The slot-cutting may be avoided by simply positioning the ring about 1" from the rear end of the engine tube. The # 8 series can take an engine lock if the engine tube protrudes about 1/2".

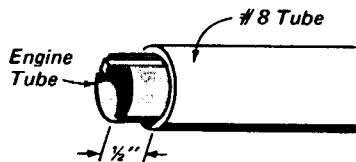

8 Tube

Engine Tube

1/2"

An engine lock can be installed on a rocket which is built from the # 7 series tube, but the engine lock will be exposed. The engine lock is secured by simply cutting a slit in the mount at the base of the thrust ring, inserting one end of the lock into the slit and securing in place with the mylar lock ring. (Centuri Engine Locks EL-1 include mylar lock rings.) If you wish to use an engine lock on a # 7 tube rocket, it must be installed BEFORE the fins are attached.

Adapting an engine lock to a # 7 body tube (exposed)

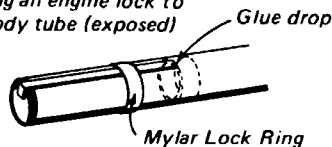

Glue drop

Mylar Lock Ring

LAUNCH LUGS

In the case of a straight single diameter rocket, the launch lug is simply glued right to the body tube. The lug should be attached at the approximate CG of the rocket. After the lug is positioned on the body, sight along the launch lug to insure it is parallel with the body tube. Once the glue is dry, you may wish to run a small fillet of glue along the launch lug-body joint for added strength.

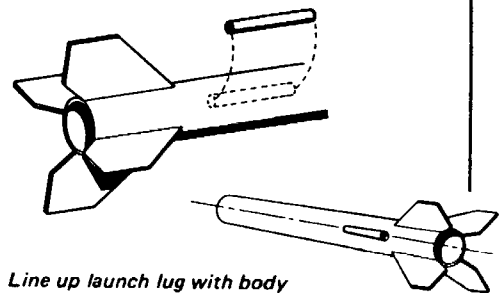

Line up launch lug with body

Long rockets may require two launch lugs. Check for good alignment by running a launch rod through them.

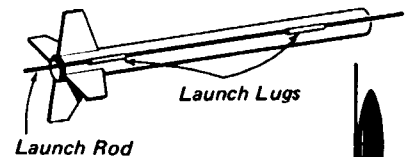

Launch Lugs

Launch Rod

Standoff

If the rocket has an enlarged payload capsule, the launch lug must be mounted on a "stand-off".



NOSE CONES & CAPSULES.

Nose cone and payload capsule bases should be checked to insure a perfect fit. The bases should fit snugly but not tightly into the body tube. A tight fit may cause malfunction of the recovery system. A fit that is extremely loose may allow the cone to come off during the thrusting phase. If the fit is too tight, a little sanding will take care of the problem. If the fit is too loose, wrap a turn or two of tape around the base.

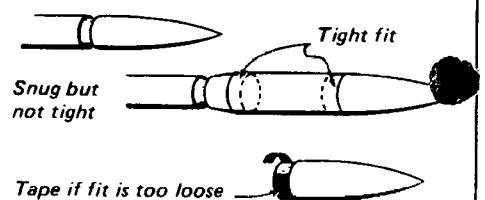

Tight fit

Snug but not tight

Tape if fit is too loose

Plastic nose cones or reducers may be permanently joined to paper body tubes by applying tape or pressure-sensitive paper to the plastic parts base. This allows for a paper-to-paper joint with regular glue.

Apply a pressure-sensitive tab to the larger shoulder of the plastic reducer. Test-fit the reducer, and remove it. Run a generous bead of glue around inside of one end of tube. Insert reducer with smooth, even motion.

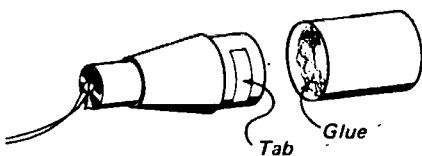

SHOCK CORDS

Centuri kits use several types of shock cord material. Some is nylon-covered elastic (the same as used by tailors for waistbands). This kind is extremely strong. Other kits use thin rubber strips (the same as used in rubber-powered model airplanes). This kind has considerable stretch ability. Rockets with small nose cones use 16" to 24". Those with big cones, or payload sections use 36" or more.

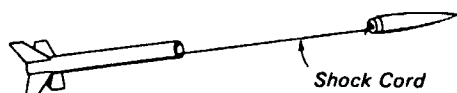

SHOCK CORD ATTACHMENT

The shock cord is an important part of the rocket's recovery system and must be strongly anchored to both the body tube and nose cone.

A. TUBE-SLIT METHOD

This is the most common method used and is particularly good for fast field repairs.

Cut two slits clear through tube as shown. Depress tube between slits. Insert one end of shock cord into body tube from top end. Bring cord out of tube through the first slit and back into tube through second slit. Push paper back into place and apply glue around the cord/tube connection.

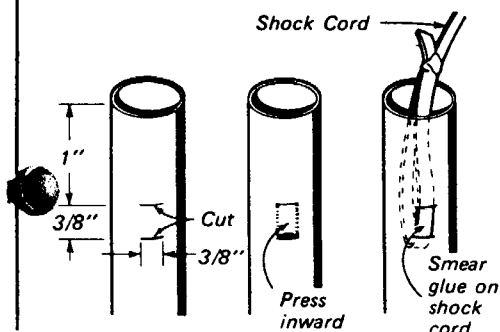

B. SCF METHOD

By far the best and easiest way to attach a shock cord to your rocket is by using Centuri's Shock Cord Fasteners, Cat. No. SCF-1. These fasteners are very strong and have a permanent, pressure sensitive backing. To install, simply remove the backing material, loop the shock cord through the holes as shown, and press the Fastener in place firmly inside the body tube. Make sure the Fastener is far enough inside the body tube to clear the nose cone base when it is set in place on the rocket. The fastener must be checked before each flight, as it sometimes comes loose sitting in the hot sun.

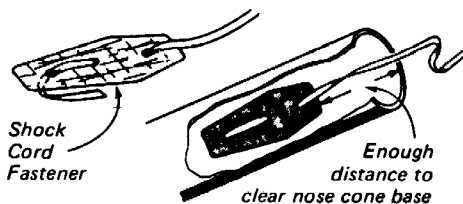

C. PAPER-TAB METHOD

This is the best technique for extremely small or extremely large diameter rockets. Cut a rectangular tab from heavy manilla board or a section of body tube as shown. Tie the cord around it and glue in place.

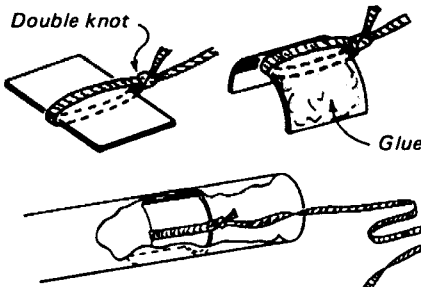

NOSE CONE ATTACHMENT

The shock cord is secured to a balsa nose cone by means of a screw eye.

Screw the metal screw eye into the center of the nose cone base. Unscrew it and squirt a drop of glue into the hole. Rescrew the eye in place to its full depth.

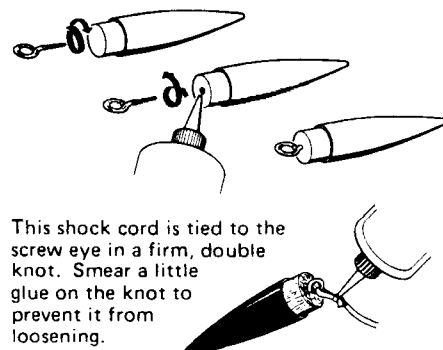

With Centuri plastic nose cones, an attachment lug is part of the base. Simply tie and glue shock cord to attachment lug.

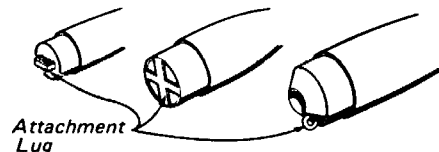

PARACHUTE ATTACHMENT

Parachutes may be attached in several ways: The shroud lines may be tied to the screw eye or nose cone lug, or they may be tied to the eye of a snap swivel. The snap swivel can then be attached to the nose cone. The snap swivel not only keeps the shroud lines from becoming tangled, but allows quick interchange of parachutes from different models.

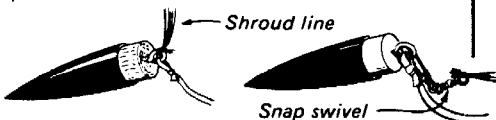

Another technique is to first tie the cord thru the eyelet, and then tie its free end around the shroud line loop.

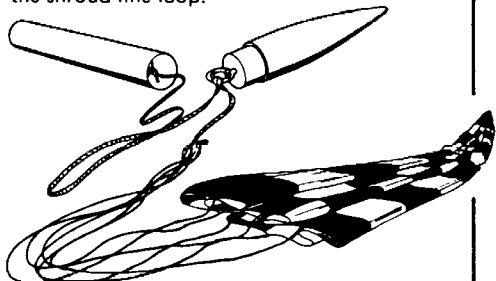

HOME-MADE PAPER REDUCERS

Making your own paper reducers (or shroud) requires drafting tools, practice and lots of precision!

- ① You must know dimensions
A: _____
B: _____
C: _____
- ② Transfer onto card stock, along a centerline to determine a center-point.

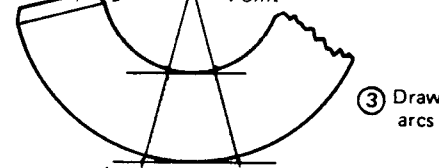
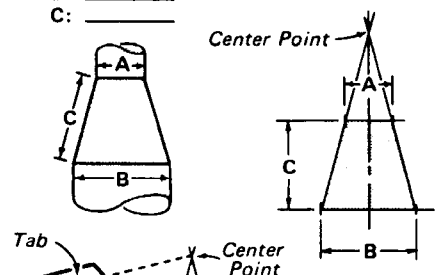

- ③ Draw arcs



Construction: Finishing

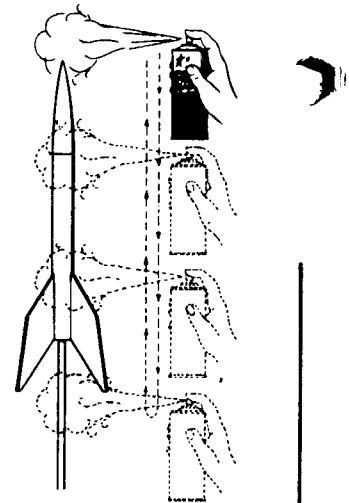

ROCKET FINISHING:

A sharp paint job is the key to an attractive rocket . . . Even a poorly assembled "bird" will come off well with a neat paint treatment! Rockets painted with bold, dramatic colors (white red and yellow-orange are favorites), show up well against the sky.

Some rocketeers produce "birds" that look like they were painted with a toothbrush, or a chocolate bar . . . just because they didn't know the tricks of the trade! This article should take the mystery out of model rocket painting. Read on, True Believer!

BALSA FINISHING:

Many rockets (but not all) have some balsa wood parts. In order to have a smooth finish appearance AFTER having been painted, balsa wood must be filled and sanded BEFORE painting. This step is not needed on rockets with fibre-fins or plastic nose cones, which is why many rocketeers prefer them.

Since you have sanded the balsa fins to shape prior to attachment to the body, it is only necessary to lightly sand the surface with very fine sandpaper. Next, the fins are painted with a special filler preparation such as "sanding sealer" or "balsa fillercoat" (found in most hobby stores). It fills grain lines and dries hard in 30 minutes. Apply two coats at 15 minute intervals. Sand the fins with medium fine sandpaper after 30 - 45 minutes have elapsed. Apply another coat of filler, let dry and sand lightly to a smooth glassy finish. Balsa nose cones must be prepared in the same manner as the fins. Cup the fine sandpaper in your hand, and turn the nose cone gently into it to produce an even surface.

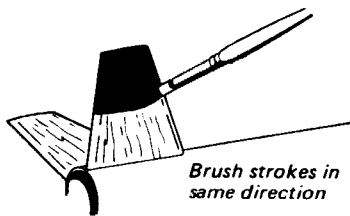
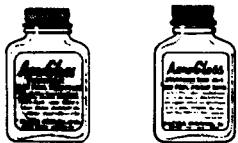

First coat of fil-cote



2nd coat of fil-cote



After sanding



3rd coat of fil-cote



After final sanding

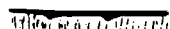

ROCKET PAINTING:

A word of caution: Do not paint any plastic parts with dope paints. These paints will cause the plastic to soften, wrinkle, and in some cases, actually melt. Use only enamels on plastic parts.

Centuri body tubes should not be sanded. They have a poly-glassine coating which accepts all types of paint easily.

Spray paint which comes in aerosol cans is the best and fastest way to paint. Spray enamel or lacquerized enamel (such as "Krylon"), produces a very smooth finish, but must be done correctly to avoid runs and unsightly sags.

First, make a simple holder for your rocket out of an empty engine casing and a coathanger or dowel. . . or glue casings to a wooden block or base.

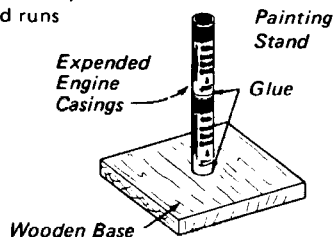

Select a clean well ventilated area in which to paint. Spray with even passes of the can. Do not start or stop spraying when the spray is directly on the model. Spray a light mist coat and STOP—Allow the paint to dry. Do not try to finish the painting in one spraying. . . Chances are 10 to 1 you will ruin the finish. After this coat dries, spray another mist coat.

The third coat is a "wet coat" and requires more care. Move the spray can up and down in slower arcs, allowing a heavier coating. It will have a wet glossy appearance. Do not deposit too much paint in one area or runs will result. Allow to dry 3 or 4 hours, before handling. The paint should dry with a glass-smooth, hi-gloss finish that looks super-professional.

Model airplane dope may be used instead, if you prefer. It brushes easily and dries hard in 15 to 20 minutes. Enamel is usually thicker and heavier and takes longer to dry. It is generally, however, more durable than dope which may peel and shrink. Use a good quality flat brush. Run the brush strokes in one direction and do not go back over an area which has just been painted. Figure at least three coats of dope to produce a good finish, as most dope colors are translucent.

MULTI-COLOR PAINTING:

The model will have to be masked before application of the second color. It should dry for at least 24 hours before masking, or the paint may pull loose when the masking tape is removed. Press tape against a piece of glass to remove some adhesive and avoid lifting the paint. Cover the large areas with paper and carefully tape in place. Avoid breaks or open seams through which the second color might leak.

2nd color to be applied here.



Masking Tape

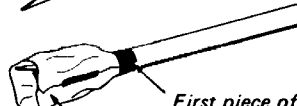

First piece of masking tape

Paper

2nd color to be applied here.

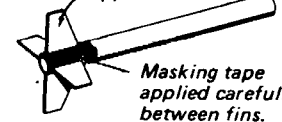

Masking tape applied carefully between fins.

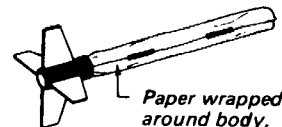

Paper wrapped around body.

The model is ready for decals, after paint is dry. Follow application instructions printed on the back of the decal sheet. Press all air bubbles from the surface and remove any excess water by gently blotting. Trim tape is quite easy to apply to the model and cut off where desired. It is advisable to give the completed model a coat of clear spray paint. This should be done only after the decals are thoroughly set and all water has evaporated. Let the model dry overnight before launching.

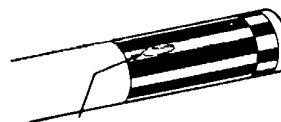

Remove air bubbles by gently pressing decal with soft cloth.

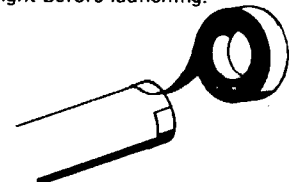

Applying trim tape. (Centuri Pro-Stripe Tape)

Construction: Parachutes

PARACHUTE DESIGN

These methods can be used with a variety of materials, such as thin film from plastic dry cleaner bags and trash bags, or chrome mylar which is quite popular. The mylar is stronger and more heat resistant than plastic and is much thinner (.0005") which allows it to be folded into a smaller chute compartment. Another advantage is the mylar's reflective surface which makes it highly visible during descent.

Cloth such as thin silk or rayon may be used, but the shroud lines must be sewn in place, rather than taped to the cloth.

Choose the thinnest possible material to allow for compact size and smooth ejection. If the rocket tends to drift during descent a small spill hole can be cut in the center of the parachute. While this makes the rocket come down faster, it also reduces the drift.

STREAMER DESIGN

Streamers are generally used on very small rockets (weighing less than one ounce), or extremely high altitude birds to avoid the rocket drifting away by chute.

Streamers are made of brightly colored plastic film, or better yet: Ordinary crepe paper, which is flameproof.

Here are good "rules-of-thumb" on streamer sizes:

- A. Length-to-width ratio: At least 10 to 1.
- B. Surface area: At least 36 square inches per ounce of ejected weight (rocket plus expended engine).

WAYS TO ATTACH STREAMER

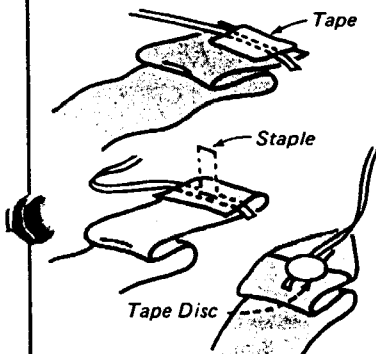

Approx. Rocket Descent Wt.	PARACHUTE SIZE		
	Square	Hexagon	Octagon
1oz. 2oz.	D=14"	D=13"	D=12"
2oz. 3oz.	D=18"	D=17"	D=16"
3oz. 6oz.	D=24"	D=22"	D=20"
6oz. 10oz.	D=28"	D=26"	D=24"

"D" is the width dimension of the parachute square, as shown in the first step of each type.

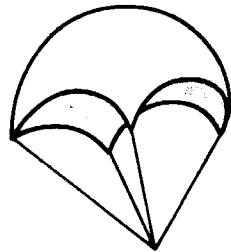

SQUARE:

A square piece of material is cut to the desired size. Shroud lines are attached to the corners with tape discs. The shroud lines are pulled tight and tied to complete the chute.

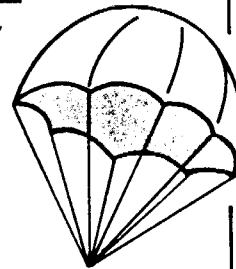
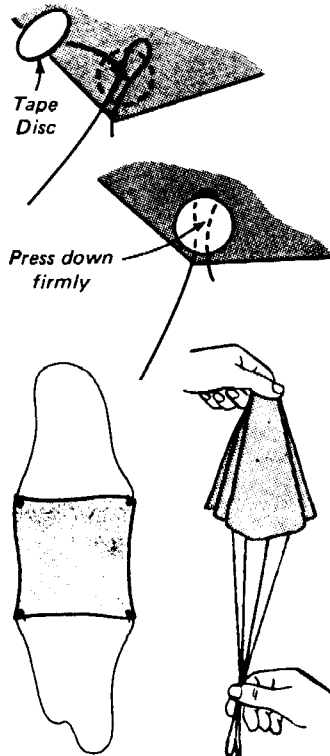

OCTAGON:

Cut the piece of paper as before, with each side equaling the desired "D" dimension. Fold the paper in half and fold again to form a square one-fourth the original size. (See below). Fold this on a 45 degree angle. Mark length "B" equal to length "A". Draw a line across and cut to complete pattern. The chute is cut out, shroud lines are cut, attached and tied to finish it.

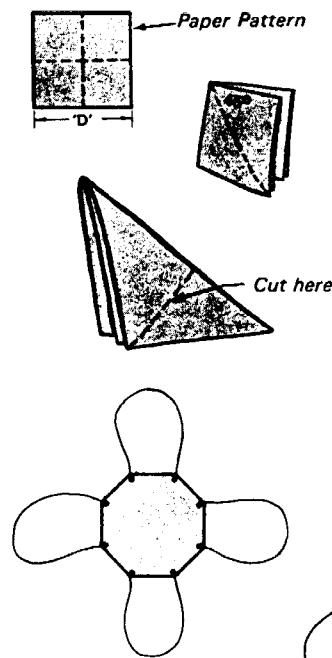

FORMULA FOR CUTTING PARACHUTE SHROUD LINES

SHROUD LINE LOOP LENGTH	
SQUARE	2½ TO 3 TIMES "D"
HEXAGON or OCTAGON	2 TO 2½ TIMES "D"

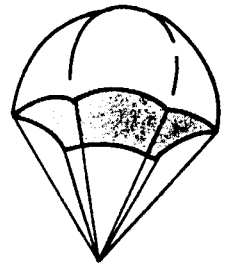

HEXAGON:

Cut a square piece of paper to size so that each side equals the desired dimension "D" of the chute. Fold the paper into a right triangle. Mark the paper with a 30-60-90° triangle and fold the legs over as shown. Cut across the folded paper to complete the pattern. Lay the pattern on the chute material and cut out. Attach shroud lines and tie ends to complete.

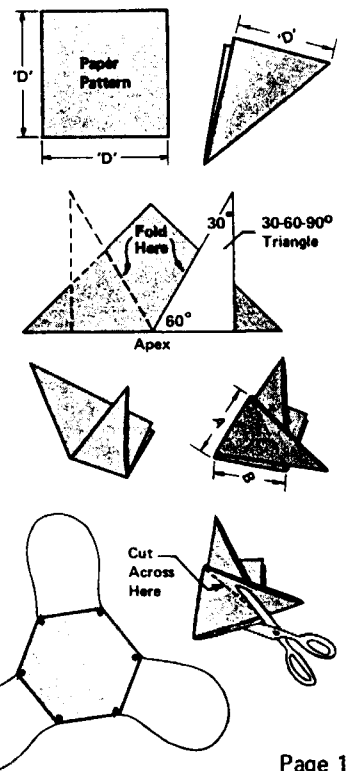



A CHOICE SELECTION OF GREAT STYLING IDEAS! SOME REQUIRE MORE REARWARD FIN AREA FOR STABLE FLIGHTS AS MODELS.

Real Birds

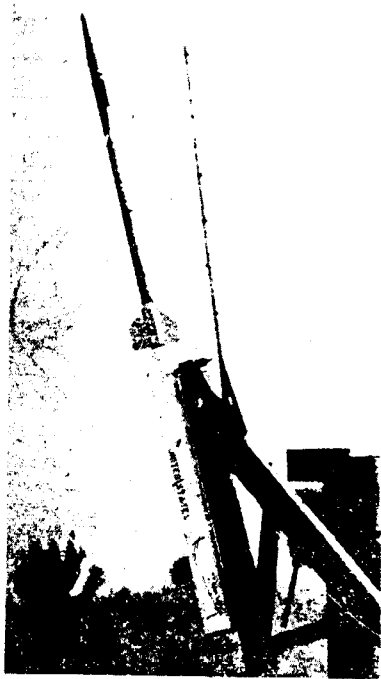

Nike-Apache (NASA)



Argo D-8 (NASA)



Matador Cruise Missile (USAF)



Honest John at White Sands. Pre-

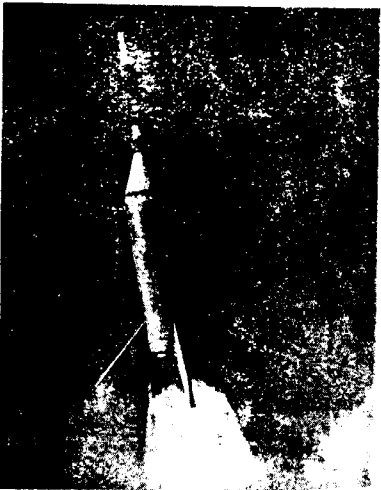

Little Joe-Sam (NASA)

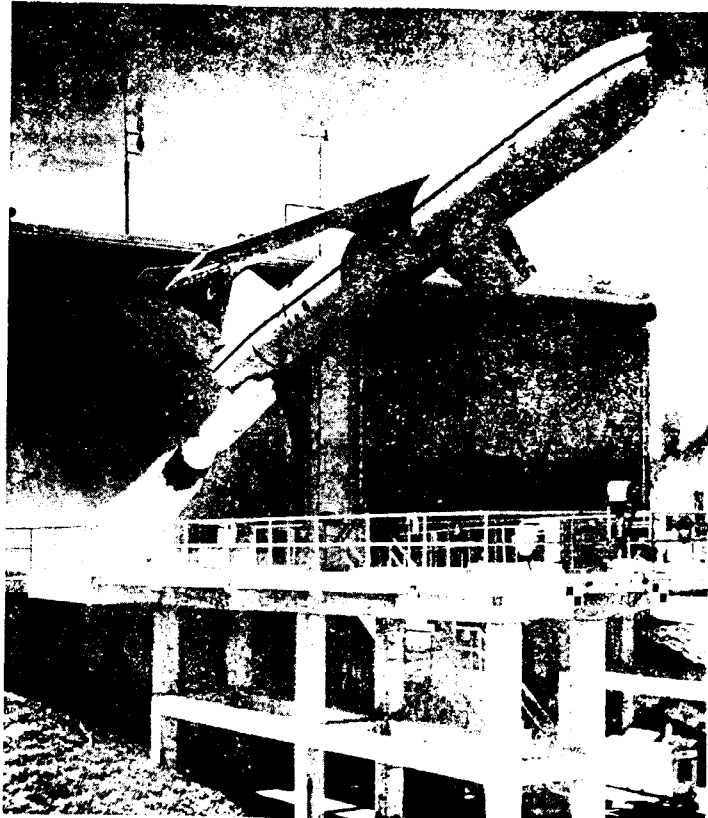

Mace leaving its shielded launch site. (USAF)



Vostok (USSR)

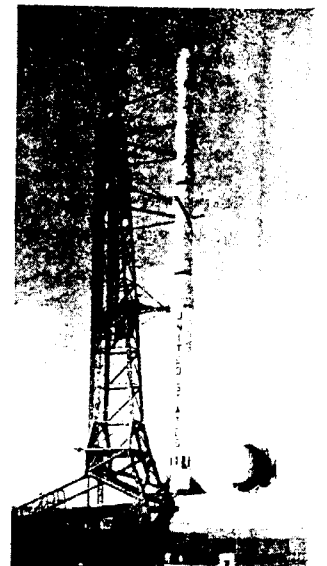

Scout (NASA)

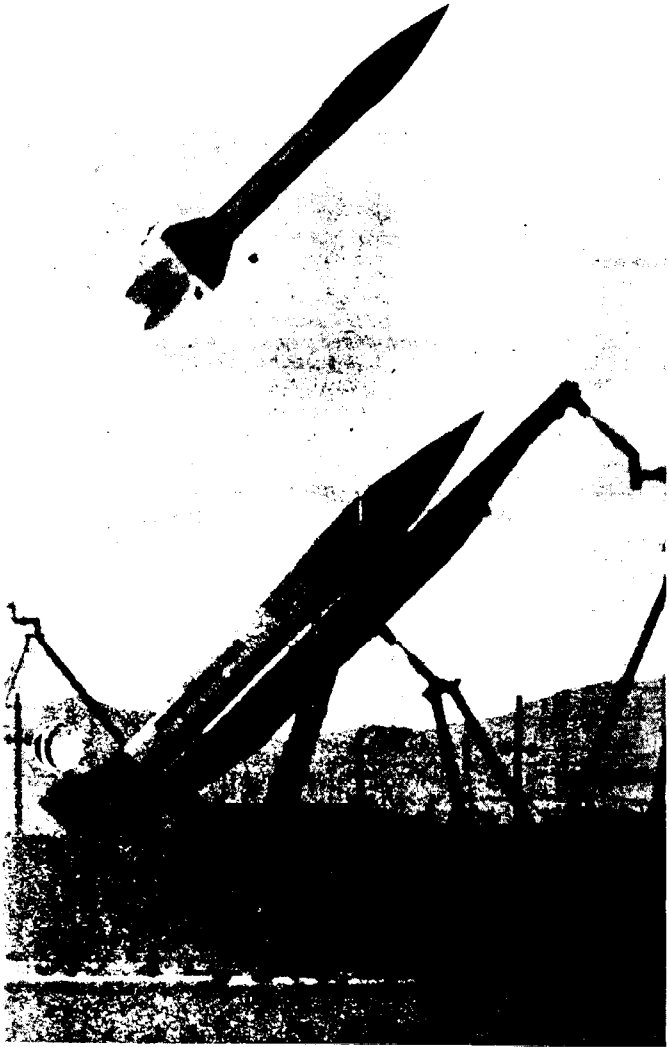

... had bigger fins. (ARMY)

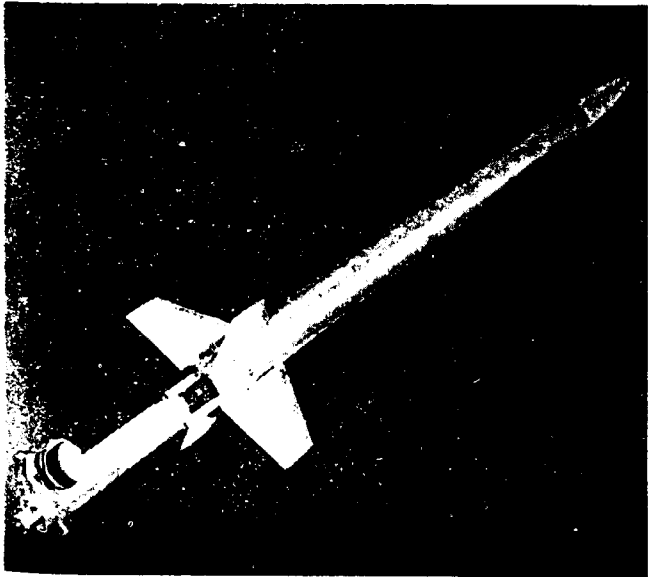

Arcon with booster. (Atlantic Research Corp.)



Bomarc Interceptor (USAF)

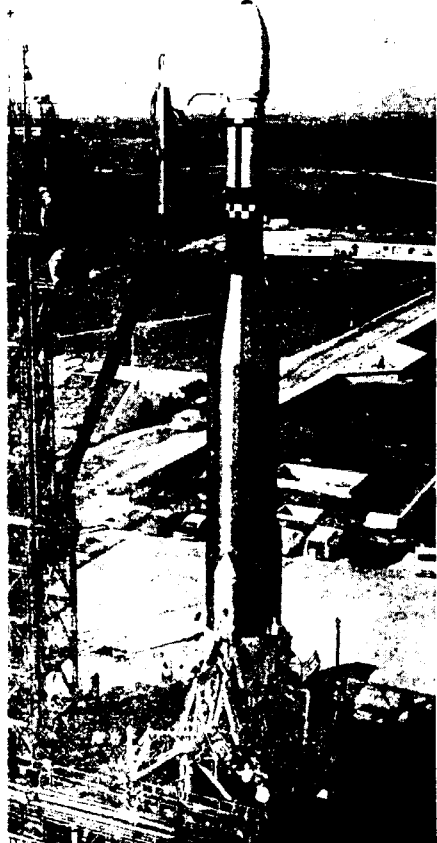

Atlas D-Agena Mariner (NASA)

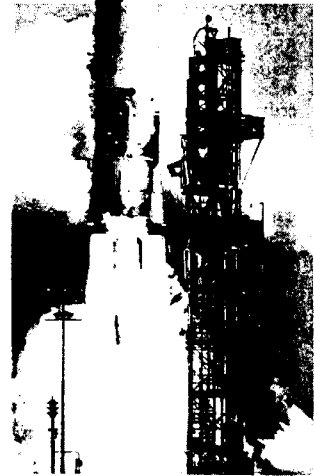

Mercury Atlas (NASA)

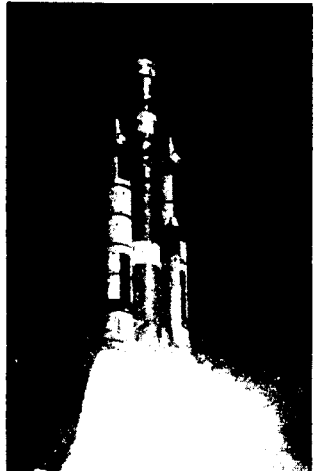

Titan III-C (USAF)

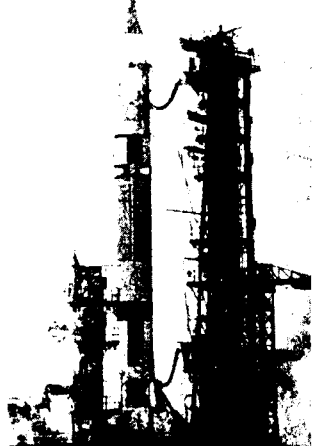

Gemini-Titan II (NASA)



Projects: Altitude

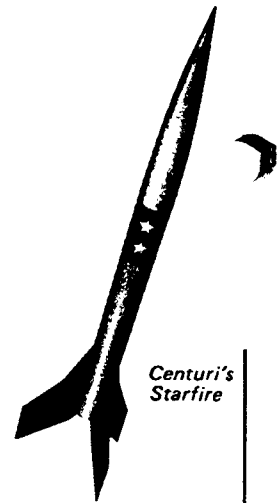

Centuri's
Starfire

INTRODUCTION

Back in the PERFORMANCE section on page 6 we talked about many basic techniques for increasing altitude.

Using just a few of those techniques and the ones here will not significantly improve altitude. . . but using many of them together can make a big difference! In fact, a true high-altitude rocket travels at less than the speed of sound and looks quite different from supersonic rockets used by scientists.

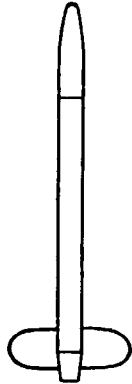

MULTI-STAGING

This is perhaps the easiest way to increase altitude and is explained fully on pages 20 & 21. Here in this ALTITUDE section we are more concerned with single-stage birds.

FIN SHAPES

There are thousands of possible fin shapes, but some are much better than others for reducing drag (see page 6, first column). Here is an example.

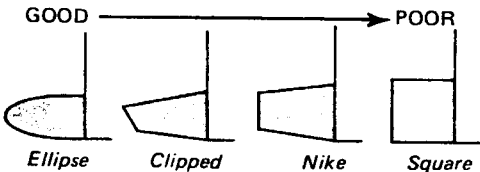

Here are variations on the above styles:

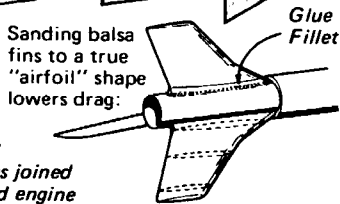
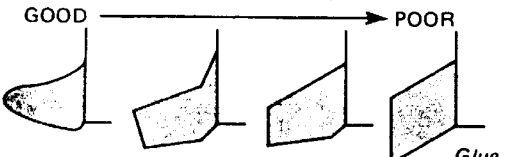

Tower:
#7 tubes joined
with old engine
casings

LAUNCH-LUG ALTERNATIVES

Finding a safe way to safely eliminate the launch lug can decrease drag as much as 15% on a small rocket. A tower launcher is one way.

REAR-EJECTION

This technique allows gluing the nose cone permanently in place and completely eliminating the seam.

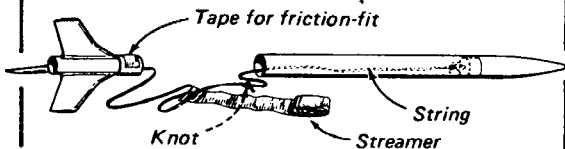

WEIGHT OPTIMIZING

Optimum weight means simply the ideal weight of a specific rocket and engine combination for attaining maximum altitude. Too much weight obviously causes the rocket to be weighed down while having too little weight fails to give enough inertia to overcome drag efficiently and reach peak altitude.

Most model rocket kits are designed slightly above optimum weight, for sturdiness and ease of construction. The "ACTUAL" section of the chart below shows the approximate altitude of a reasonably well-built Starfire with each recommended engine. Note that engine weight must be added to kit weight to determine the flying weight. The "OPTIMUM" section assumes that the Starfire's weight has been cut down severely, especially for the lower power engines.

Altitude and weight figures on this page were determined from Centuri's "TIR-100 Model Rocket Altitude Performance" (see inside back cover).

ACTUAL					OPTIMUM		
Recc. Engine	Engine Weight	Kit Weight	Flying Weight	Altitude in Feet	Recc. Engine	Loaded Weight	Altitude in Feet
½A6-2	0.5	1.0	1.5	110	½A6-4 See note 1	0.45 See note 3	290
A8-5	0.6	1.0	1.6	320	A8-5	0.75	455
B4-6	0.7	1.0	1.7	700	B4-6	1.10	765
B6-6	0.7	1.0	1.7	690	B6-6	1.10	750
B14-7	0.7	1.0	1.7	685	B14-5 See note 2	1.25	730
C6-7	0.9	1.0	1.9	1230	C6-7	1.65	1240

NOTE 1: The ½A6-2 has too short a delay. We have substituted a ½A6-4.

NOTE 2: The B14-7 has too long a delay so we substituted the B14-5.

NOTE 3: This situation is impossible; an engine alone weighs more than .45 oz.

The chart below is a guide to determine optimum weight for any combination of rocket diameter and engine. These figures are very general, depending on rocket length, workmanship and many other factors. As in the previous chart the ideal weights for the low power combinations are virtually impossible, but cutting down even a little weight will greatly increase altitude in those ranges.

OPTIMUM WEIGHT

	ROCKET SIZE (Approximate Diameter)					
	.7"	.9"	1.0"	1.3"	1.6"	2.0"
½A6-2	N/A*	N/A	N/A			
½A6-4	0.35	0.45	0.50			
A8-3		0.75	0.80	0.90		
A8-5	0.65	0.75	N/A	N/A		
B4-2				N/A	N/A	N/A
B4-4	1.00	1.10	1.15	1.25	1.30	
B4-6	1.00	1.10	N/A	N/A		
B6-4	N/A	1.10	1.15	1.25	1.40	
B6-6	1.00	1.10	N/A	N/A		
B14-5	1.10	1.25	1.35	1.50	1.65	
B14-7	1.10	N/A	N/A			
C6-3				N/A	1.85	1.90
C6-5		1.65	1.70	1.80	1.85	N/A
C6-7	1.50	1.65	N/A	N/A		

* "N/A" means that the engine's delay time is either too short or too long for altitude optimization in the diameter shown; but the engine may be used for sport flying.

Here are a few weight-saving techniques to experiment with: use Mini-motors, hollowed-out balsa parts, stepping down to narrow tube on forward end of rocket, use light-weight surface sealer, peeling interior layer of body tube, combining parts (such as making a coupler also serve as a thrust ring).

Projects: Payloads

INTRODUCTION

Many model rockets have special compartments built for carrying some sort of "cargo". There are many types of these "payloaders".

BIOLOGICAL

Model rocketry is a great way of testing the effects of acceleration. Some rocketeers try to fit a mouse or hamster into their rocket and fire it into the air. **WE DO NOT RECOMMEND THIS.** At the conclusion of the so-called "test" the mouse is either dead, or alive but badly frightened from the shock of lift-off. Insects may be used because they have tough shells (called exo-skeletons) which act as "pressure suits". Simpler lifeforms such as flatworms, hydra and one-celled organisms are better yet due to their light weight. Some are transparent, so that you can observe effects of acceleration. Also, they reproduce rapidly enough for you to observe effects on future generations.

ALTITUDE CONTESTS

Some rocketeers compete in altitude events by using a lead weight of uniform size and weight ($\frac{3}{4}$ " diameter, 1 ounce, at least 60% lead). This is called the "F.A.I. standard" and is recognized internationally. It will not quite fit into the same body tube used for engines and thus presents a design challenge.

EGG LOFTING

Here is an exciting contest requiring considerable skill: Launch a raw Grade A hen's egg (between 2 and 2.25 ounces) with a specific engine power . . . the highest altitude determines the winner. The catch is that the egg must be recovered intact and unbroken!

INSTRUMENTATION

A few very advanced rocketeers are able to construct electronic devices as payloads which measure some aspect of the rocket's flight, such as roll rate, speed, air temperature, etc. Centuri offers no plans or parts for the activity as it is a very specialized area.

PAYLOAD PROTECTION

An accelerating rocket can experience more than 20 "G's" at lift-off. A "G" is the force of one Earth gravity. Here are suggested ways of cushioning a payload against this considerable shock: foam rubber, cotton batting, gauze bandaging, surrounding with tiny balloons, or inside a water-filled container.

BASIC PAYLOAD SECTIONS

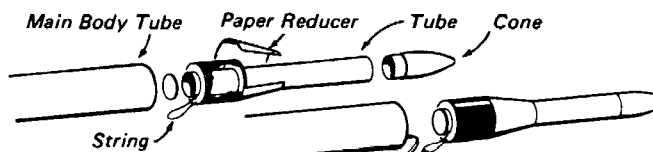
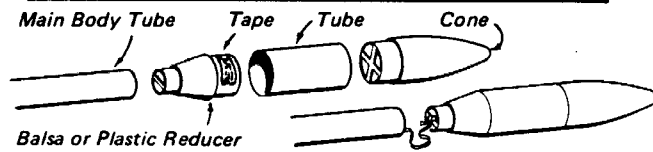
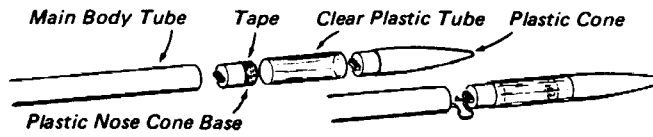
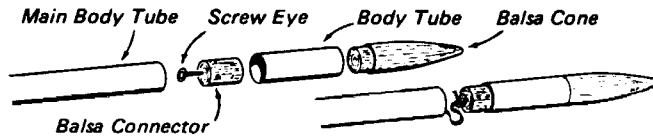

Centuri's Egg Capsule (No. PNC-13E/ST-202)

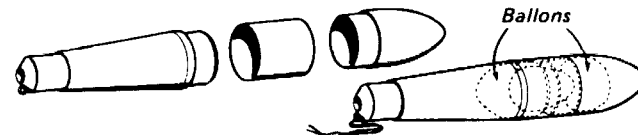

OPTIMUM FIN SIZE:

A rocket with a payload generally requires less fin area for stability than the same rocket flown empty. If your rocket is stable when flown empty, you may decrease fin area approximately 15 to 25% when flying a payload that is about half the empty rocket's weight.



PAYLOAD ENGINE SELECTION

A modest payload ($\frac{1}{2}$ ounce or so) may generally be flown with the same engine the empty rocket would use. Heavier payloads (1 ounce or more) require the next shorter delay time because the rocket is noticeably heavier and won't coast as high (ex: C6-5 instead of C6-7).

Some engines have high initial thrust, making them great for getting a heavy bird moving. The B14 series is especially designed for load-lifting.

A WINNING DESIGN

Here at the right is a payload design that was just sent to us by Tihomir Marjanac, Yugoslavia, where model rocketry is very popular. It's constructed quite cleverly using two Centuri plastic parts to form the payload cone. This rocket took second place in the 1974 Yugoslavian Nationals for "Tihi".

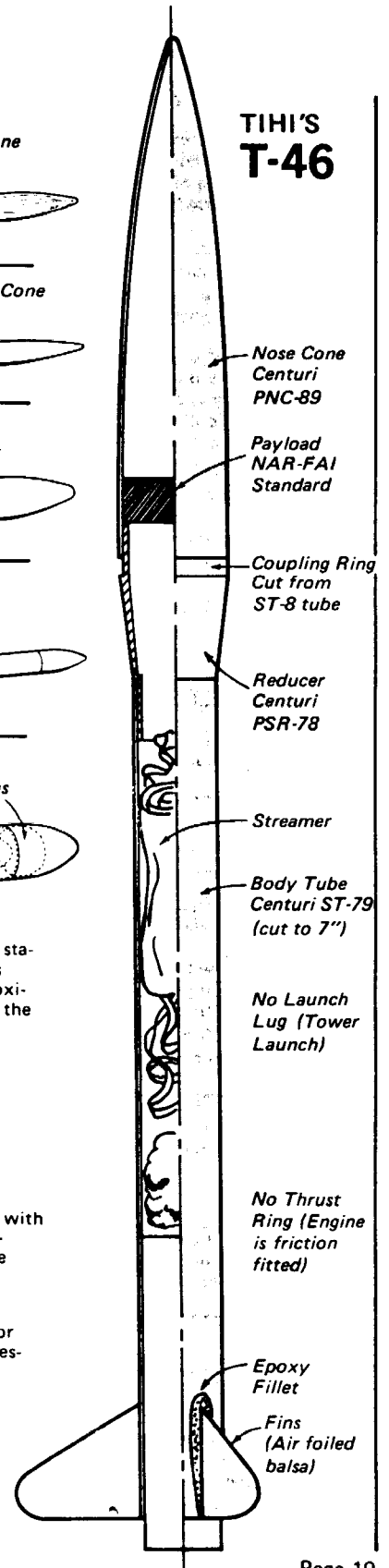



Projects: Staging

INTRODUCTION

Multi-staging is an excellent way to attain high altitudes with a model. An understanding of basic staging principles is needed to fly any 2 or 3 stage "bird" successfully. Staged models require extra care in assembly and handling as they are about twice as challenging as standard model rocket.

Staging is a concept where one engine's velocity is added to an already existing velocity of another engine. To illustrate, we will use a typical 2-stage design

based on a #7 body tube diameter. A variety of terms are used to name the main parts of a multi-stage rocket.



1st Stage
Lower Stage
Booster

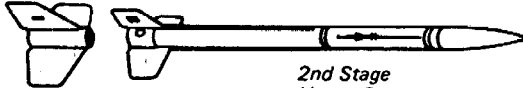

2nd Stage
Upper Stage
Sustainer

PASSPORT STAGING (U.S. Pat. No. 3,721,193)

The booster (or 1st stage engine) is ignited by a standard electrical model rocket launch system.

The engine contains propellant, but no delay or ejection material, and designated with a code ending in zero (example: A8-0).



As the intense flame burns forward, it breaks through the top of the propellant grain. Hot particles of still-burning propellant shoot forward into the nozzle of the second stage engine, igniting its propellant. (Ordinary flame, such as from a match, will not ignite model rocket engines).



In the Centuri Pass-Port Staging System, some of the rapidly expanding gases are allowed to escape through the 2 ports in the coupler joining the stages. This allows just enough time (a split second) to ignite the next stage before the first stage blows away completely.

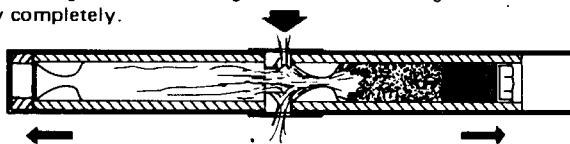

The first stage alone is an aerodynamically unstable body that will tumble or glide safely to Earth. Meanwhile, the second stage climbs, the thrust of the second stage being added to the already existing velocity created by the first stage. The upper stage contains a recovery system and an engine with the standard configuration of propellant, delay and ejection material.

DESIGN & CONSTRUCTION

Multi-staged birds generally have larger fins toward the bottom (aft end) than on the upper stages, as shown in the left illustration here. This helps flight stability by maintaining a proportionate amount of fin area as each exhausted stage is blown away. However, extremely long rockets, such as the three foot one on the far right, may have all fins the same size.

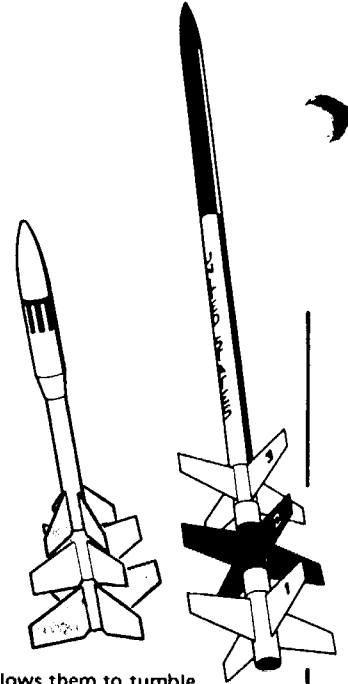

In any event, a booster must be properly balanced with the Center of Gravity at the Center of Pressure. This allows them to tumble, minimizing damage, rather than streamlining to earth. For best results, booster stages may be kept to no more than 3" or 4" in length. This will better ensure ignition of upper stages and avoid the streamlining effect of the booster at the right.

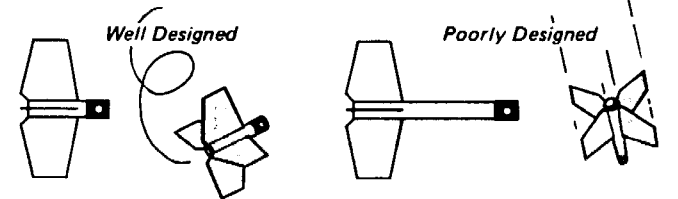

Fins must be glued on extra securely to resist damage when the booster unit lands.

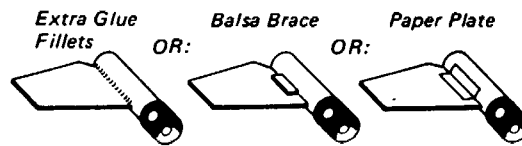

NOTE: Position coupler holes so exhaust won't burn fins.

Typical three stage construction employing Centuri's "Passport" Staging.

The uppermost stage of a well designed multi-stage bird usually may also be flown by itself as a single-stage rocket.

The number of stages possible is limited only by the available boost power of the first stage engine (the first stage engine must be able to lift the weight of all the stages and their engines). Four stages is probably the maximum and this would require extreme care in design and construction. Best all around results are obtained from rockets using a #10 series body tube.

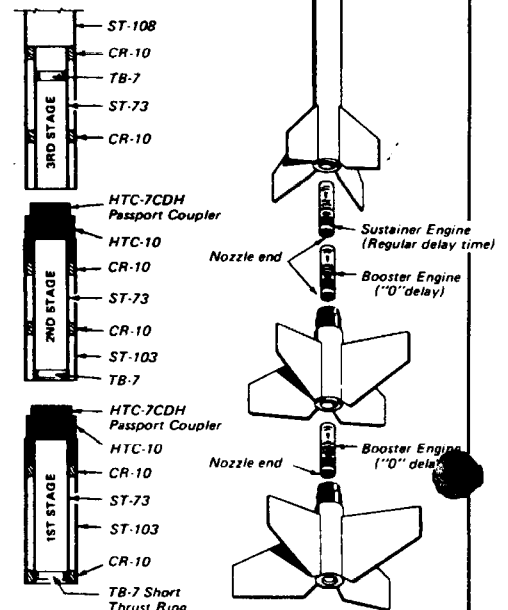

FLIGHT CHARACTERISTICS

Altitudes achieved will depend on engines chosen and on model workmanship. Remember that extremely high flights are usually unable to be "tracked" by inexperienced observers. Do not launch on overcast days as the model may be lost to sight forever.

Multi-stage rockets have a large amount of fin area, which tends to make them overly stable in flight. This causes the rocket to turn into the wind when flown in a breeze. The harder the wind, the more the tendency to "weathercock". For this reason it is advisable to fly multi-stages only in calm weather.

Staged model rockets are capable of reaching altitudes over 2000 feet. At extreme altitudes the wind speed is often greater than at surface level. A staged rocket equipped with a standard parachute may be caught in a breeze, and drift as much as several miles before returning to earth . . . so take care!

HERE ARE SEVERAL WAYS TO AVOID DRIFT:

1. Never launch in winds over 5 or 10 mph.
2. Tilt launcher slightly into wind to compensate for distance. Returning rocket will then drift back closer to launch area.
3. Some staged rockets are intentionally supplied with a streamer rather than a parachute. The drogue recovery streamer will allow the rocket to descend nearer to the launch site.

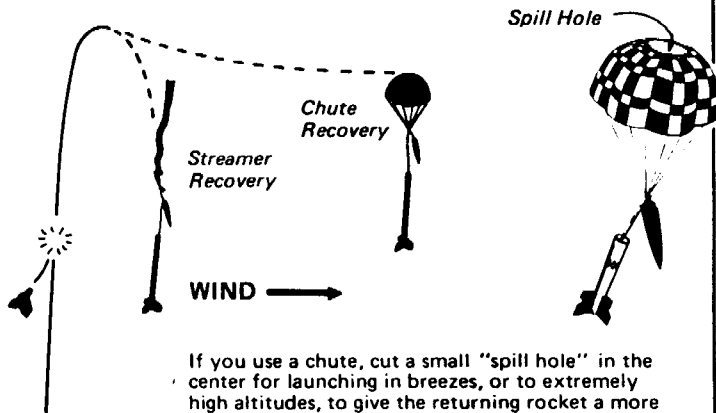

MOUNTING ENGINES

Engines must be held firmly in place to withstand forward movement while thrusting, and rearward motion during burn-through. Here are several ways:

FRICTION FIT:

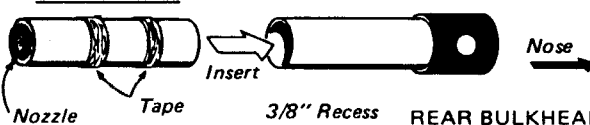

REAR BULKHEAD:



ENGINE LOCKS:

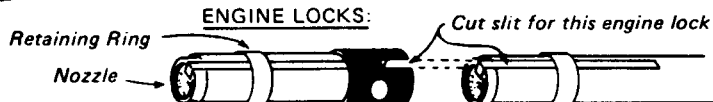

ENGINE SELECTION

Engines chosen for "own designs" can be based on Centuri catalog engine recommendations for similar sized models. The uppermost stage would usually have the longest available delay time in its' class. (Example: 1/2A6-4, A8-5, B4-6, B6-6, B14-7, or C6-7).

B14 engines, with their high initial thrust, are generally used to "lift-off" the larger and heavier staged "birds".

While "C" engines are twice as powerful as "B" engines, the "C's" do not necessarily give twice the altitude. Likewise, a two-stage rocket will not quite go twice as high as a single-stage, because some aerodynamic efficiency is lost through drag at higher air speeds.

SPECIAL FLYING PRECAUTIONS

1. Be sure to use booster type engine in each booster stage.
2. Use an engine with delay and ejection in uppermost stage.
3. Never use a standard engine in a booster because this will almost certainly cause a crash.
4. Be sure all engines have their nozzles pointing rearward.
5. When fully prepared, stages must couple together smoothly and snugly. Fit should be tight enough so that boosters do not fall out of upper stage by their own weight.
6. Fly over soft dirt or grassy areas to minimize damage to the tumbling booster as it lands.

ADVANCED STAGING TECHNIQUES

The suggestions below are for rocketeers who already have quite a lot of multi-staging experience.

GLIDING BOOSTER:

Very careful fin shaping, placement, and balancing can allow the booster to glide gently back. The Centuri Black Widow kit employs this tricky principle.

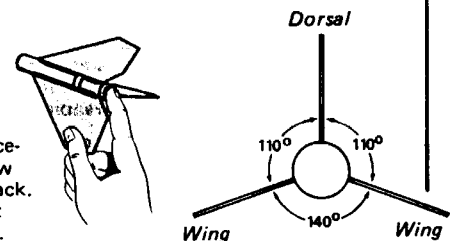

RECOVERY PODS:

Extra large booster units need their own streamer or parachute recovery. Use a side pod to store the system during flight.

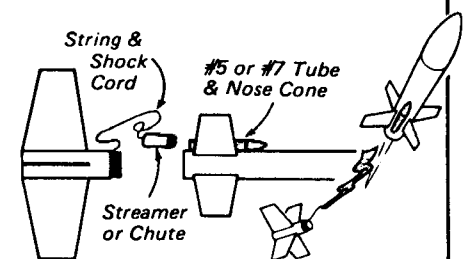

UNIBODY STAGING:

Long single stage rockets with unusually large fins may be staged simply by fitting a special mount to the rear. Swing test for stability before flight, and use good judgement.

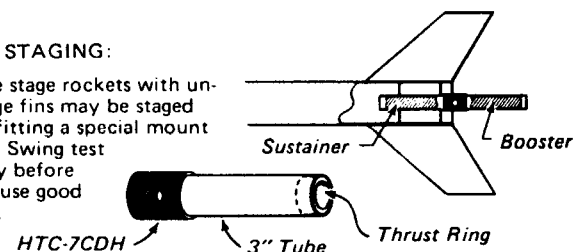



Projects: Gliding

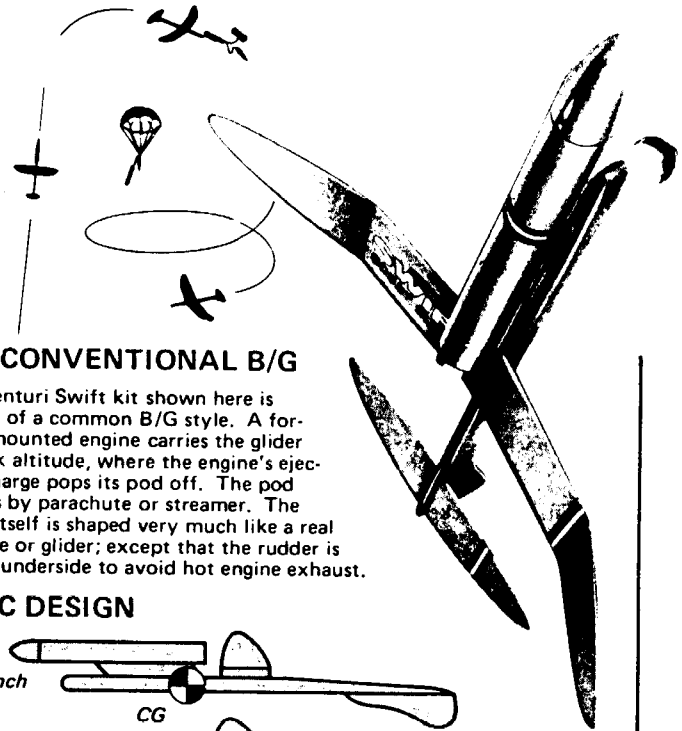

INTRODUCTION

A rocket powered glider screaming skyward, then settling into a long gentle glide recovery is a thrill for builder and spectators alike. It can only be done thru careful design and construction. You can't just slap wings onto any old rocket and expect it to glide back.

There are two basic types: Boost-Glider (B/G) where the rocket part recovers separately from the glider, and Rocket-Glider (R/G) where it all glides back as one piece. Start with one or more manufacturer's kits before moving on to your own-designs. Some are shown here (if not in your current Centuri catalog, kit has been discontinued).

We are indebted to many well-known rocketeers for much of this glider information, such as Larry Brown, Dr. Gerry Gregorek, Doug Malewicki, Gordon Mandel, Lt. David Newill, Bob Parks, Bob Royal, G. Harry Stine and many others.

GLOSSARY

AIRFOIL: Cross-section of wing. Lift is created by pressure differences, or by upper airstream being deflected "down" . . . theories vary, as to exactly what creates aerodynamic flight ability.

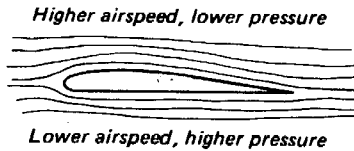

CANARD: Small forward stabilizer; sometimes moveable.

CORE EJECTION: Engine mount ejects rearward; usually carries away nose weight.

DECALAGE: Angle between wing and stabilizer; allows pulling out of dives.

DIHEDRAL:

Raising wings upward at a slight angle provided upright stability in a glide.

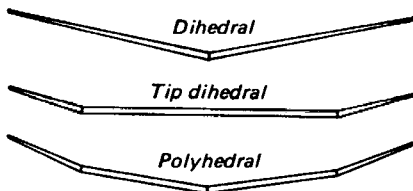

DIVE: The glider noses down rapidly.

FLAP: Control surface which deflects air; sometimes moveable (also: elevator, elevon).

FLAT PLATE LIFT: A non-airfoiled shape which obtains lift from its angle of attack; its attitude to the airstream.

PARASITE: A glider which is tacked onto a large rocket . . . one which would be stable without the glider.

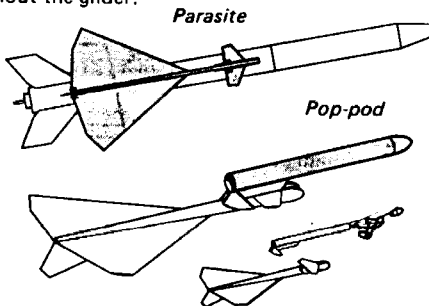

POP-POD: The rocket portion detaches by rearward movement at ejection.

RUDDER: Vertical "fin" which controls tendency to turn left or right (yaw).

STABILIZER: Horizontal surface, generally at the tail, which controls nosing up and down (pitch).

STALL: the glider climbs sharply, then dives sharply.

VARIABLE GEOMETRY: All, or a portion of the glider changes shape at ejection. Some types are Swing-wing & Scissor-wing.

WING: Main lifting surface of a glider; usually at the CG.

THE CONVENTIONAL B/G

The Centuri Swift kit shown here is typical of a common B/G style. A forward mounted engine carries the glider to peak altitude, where the engine's ejection charge pops its pod off. The pod returns by parachute or streamer. The glider itself is shaped very much like a real airplane or glider; except that the rudder is on the underside to avoid hot engine exhaust.

BASIC DESIGN

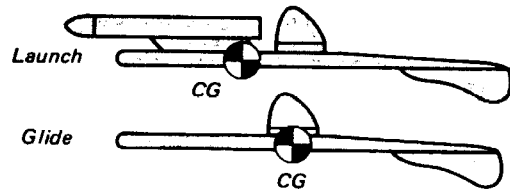

A typical pop-pod joint is shown here; there are many variations. The pod has a "hook" which pulls the glider upward during launch, but is free to back away and "pop-off" during engine ejection.

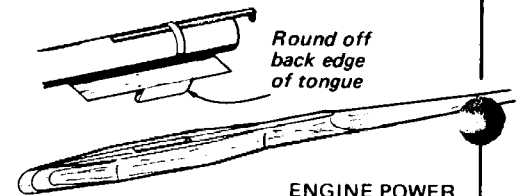

ENGINE POWER

		"1/2A"	"A"	"B"
Wing	Chord	2	2.5	3
	Span	10	12.5	15
Stab	Chord	1.2	1.5	1.8
	Span	5.0	6.75	7.5
Rudder	Chord	1.2	1.5	1.8
	Span	1.0	1.3	1.5
Body	Rear	5	6.25	7.5
	Front	2.5	3.13	3.75

Here are typical proportions for B/G glider design. Actual dimensions are given below for various power engines:

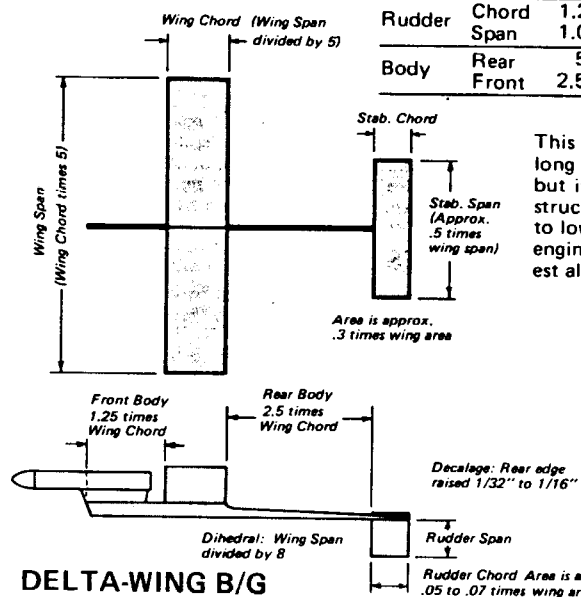

This style offers long glide duration, but its fragile structure limits it to lower power engines and modest altitudes.

DELTA-WING B/G

Another popular style is represented here by the Centuri Mini-Dactyl kit. Lift is obtained by the canard being at a slight angle (or incidence) to the wing . . . accomplished here with a tapered fuselage. This style has less basic glide ability, but can use more powerful engines due to its sturdiness. This allows greater altitude.

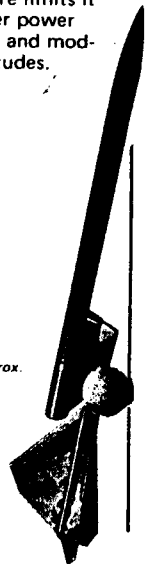

OTHER CENTURI B/G KITS (PAST & PRESENT)

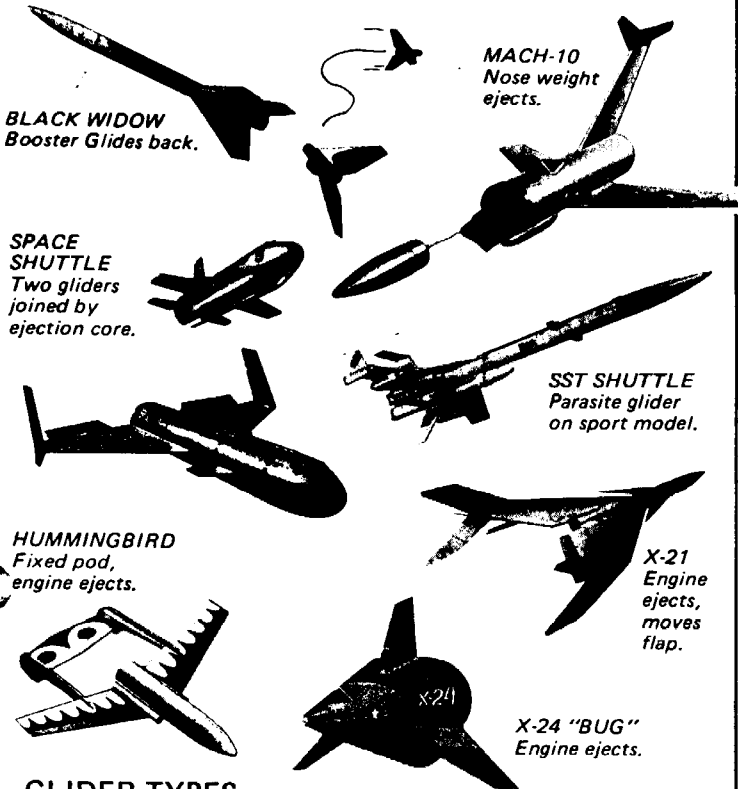

GLIDER TYPES

Literally thousands of model rocketry gliders have been designed by individuals over the years. Some of the more popular types are shown here. In creating your own you must first decide do you want a boost glider or a rocket glider? Is it for contest, sport or experimental use? Front engine or rear engine? Rigid or moveable wings? Will the glider configuration be conventional, delta-winged, rogallo, variable geometry or something else? Will it obtain lift from an airfoil, canard, flaps, angle-of-attack, or a combination of these? What makes it become a glider when the engine ejection charge fires? Consider these options: A. Engine moves the CG. B. Engine ejects. C. Core ejects containing engine mount and nose weight. D. Pop-pod detaches. E. Wings swing out. F. Flaps or canards move into position. G. A sliding weight moves or ejects. H. A glider is ejected from a payload compartment.

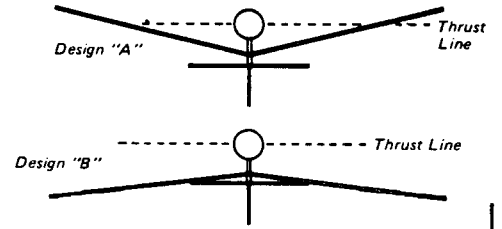
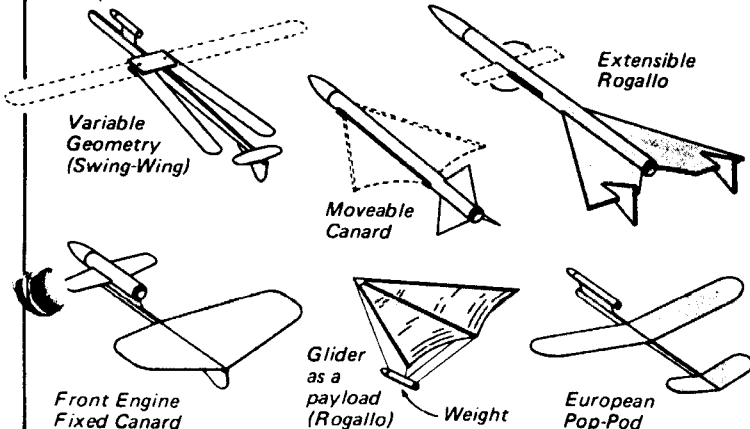

DESIGN TIPS

FIN DISTRIBUTION should allow a reasonably vertical upward flight. A little of the wing area crosses above the engine's thrust line in design "A" above. Design "B" however, has most of the "fin" below. It will probably loop and crash before reaching altitude.

EXHAUST CLEARANCE is required to avoid burning the glider during lift-off. Metallic foil may be glued onto the central wing section for further flame protection.

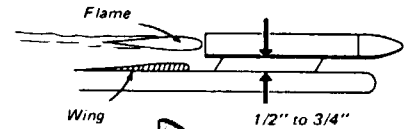

LIGHTWEIGHT WINGS can be made similar to those in flying model airplanes, then covered with tissue and dope.

CONSTRUCTION TIPS

AIRFOIL SHAPING should be done before cutting wings to form the dihedral. Reinforce glue joints with glue fillets. Use fine cloth mesh on larger models for more strength.

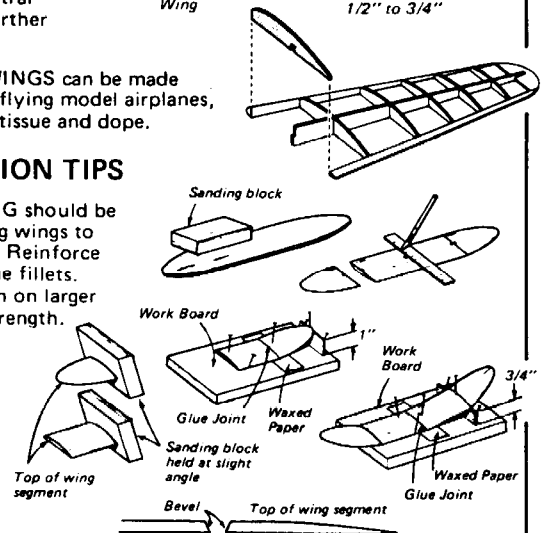

FUSELAGE (the body) should be made from very straight hard balsa or light-weight hard-wood such as birch, or balsa wood.

PAINTING THE GLIDER Many rocketeers feel that gliders should not be painted at all. It's true that many heavy coats of paint may detract from your glider's performance... BUT, properly applied, a thin, smooth coat of paint: Adds strength to the fragile structure, provides smoother aerodynamic flow, and aids in seeing the glider at great altitudes against the sky.

Here is our favorite technique: Sand all wood surfaces with very fine paper (320-400 grit) to remove loose fibres. Apply a coat of clear dope or sanding sealer to the entire wood surface. Allow to dry, and sand again. Apply a dark color on the underside, to aid visibility (spray dope, or waterproof "Magic Marker"). This technique adds so little weight, that it's almost impossible to measure it... but it greatly improves performance.

TRIMMING TIPS

Balance and trim your glider before launch by hand launching. Watch it carefully, and correct for excess dives, stalls, and turns.

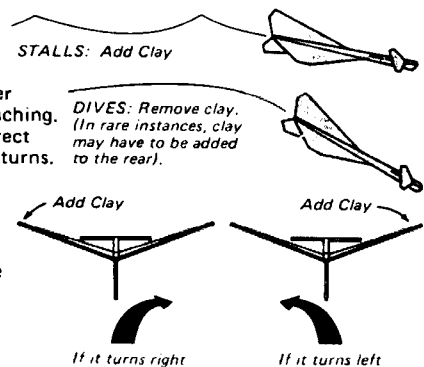

LAUNCHING TIPS

SELECT ENGINES with low average thrust when possible, to avoid high stress (examples B4 instead of B6 or B14). Use very low power engines for first test flights.

DER RED BARON has struck again when a streamer catches on the glider's tail! Use the minimum streamer length you can.



Projects: Clusters

INTRODUCTION

Clustering is the operation of several rocket engines at the same time, giving the brute force necessary to lift large and sophisticated rockets, and carry heavy payloads.

Suppose you fly four identical rockets at the same time. Each rocket goes up 500 feet. If you tie all these rockets together, the bundle of them will also fly 500 feet. Where is the advantage then?

What if instead of using four body tubes and cones, you use one larger tube and cone. You don't need four parachutes; one larger one will do. Suppose each of the four smaller rockets had used four fins apiece, for a total of sixteen; the clustered rocket doesn't need sixteen fins to fly properly. Four fins, each larger than the fins on the single engine rocket, will be sufficient. The new clustered rocket will have less drag. The air will flow smoothly around the single hull, there will be less turbulence with only four fins. In addition, you have saved weight by removing many components no longer needed. Payload can be added to the rocket in place of the unnecessary parts. You end up with a large rocket with the ability to lift weights as high as one of the smaller rockets could have gone by itself. Now you can see the advantage of clustering - clustering will lift weight.

Engines are classified by their "Total Impulse"; a letter code which shows the total power (shown in the metric system as Newton-Seconds). Centuri engines are manufactured to perform at the top of their range (A Centuri "A" is 2.50 Newton Seconds).

ENGINE CLASSIFICATION

Type	Total-Impulse (Nt-sec)
¼A	0.00 - 0.625
½A	0.626 - 1.25
A	1.25 - 2.50
B	2.51 - 5.00
C	5.01 - 10.00
D	10.01 - 20.00
E	20.01 - 40.00
F	40.01 - 80.00

The chart below shows the total impulse attainable by clustering various quantities of like engines. For instance the Centuri Saturn V kit has medium "E" power when three C6-3 engines are used to fly it.

CLUSTERED POWER

TYPE & TOT. IMP.	ENGINES IN CLUSTER		
	2	3	4
¼A .625	"½A" 1.25	"A" 1.875	"A" 2.50
½A 1.25	"A" 2.50	"B" 3.75	"B" 5.00
A 2.50	"B" 5.00	"C" 7.50	"C" 10.00
B 5.00	"C" 10.00	"E" 15.00	"D" 20.00
C 10.00	"D" 20.00	"E" 30.00	"E" 40.00

CLUSTER MOUNTS

A cluster mount is relatively simple to build, using short body tubes which the engines fit into. The tubes are fitted with thrust rings and glued together to form the cluster. Two or three engine cluster mounts will fit nicely into a #16 body tube and a four engine mount will fit easily into a #20 tube.

Gaps between cluster tubes must be filled with balsa or cardboard to prevent ejection gas from escaping to the rear.

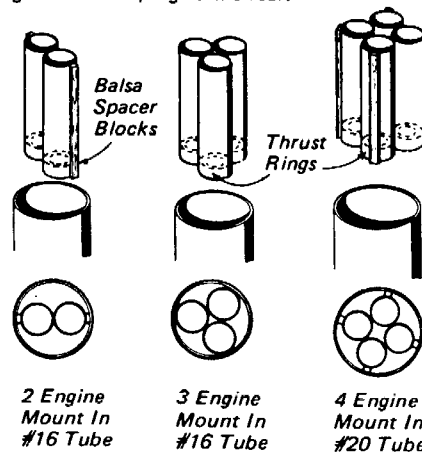

FIN DESIGN

Fins on clustered rockets should be 20% to 40% larger than a single-engine bird. This compensates for the Center-of-Gravity having moved rearward when adding the extra engines weight to the rear of the rocket.

Fin thickness should be increased when total clustered power exceeds "C", to avoid the fin's tendency to flutter and possibly shear off. For instance a 3/32" thick balsa fin should be 1/8" thick when clustering.

Further fin strength may be gained in many ways. Here are several examples.

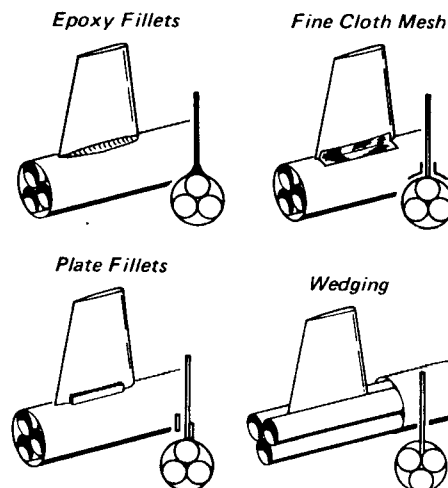

CLUSTER CLIP-WHIP

You will need to make a clip-whip to properly hook up 3 engine or 4 engine clusters. (The crimp-on-stake is optional . . . wires may be simply twisted together, soldered, then flattened with a hammer).

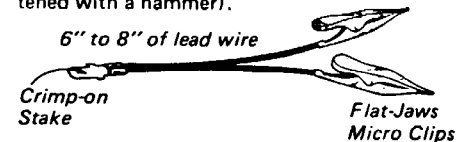

TWO ENGINE WIRING

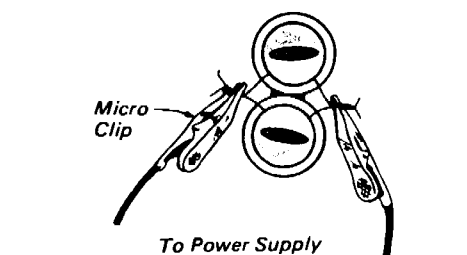

THREE ENGINE WIRING

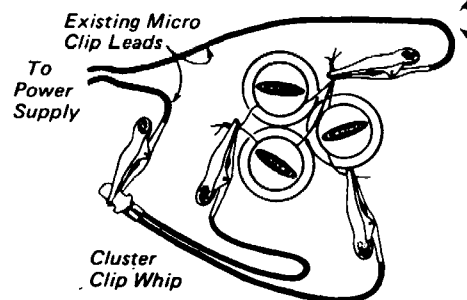

FOUR ENGINE WIRING

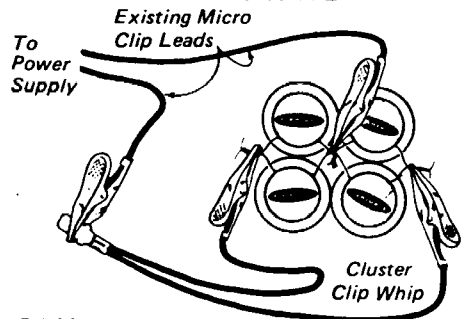

CAUTION

1. Always use a 12 volt automobile battery for the best likelihood of simultaneous ignition.
2. Do NOT hold down the launch button for more than 5 seconds . . . you may melt your launcher's wiring system!
3. Launch only in large unpopulated areas . . . clusters are simply not as reliable as standard single-engine model rockets.
4. Use extra chute wadding . . . you now have more than one ejection charge.
5. Do not attempt to fly staged clusters.

Projects: Scale



G. Harry Stine, "The Old Rocketeer," is known the world over as a pioneer of Model Rocketry. This article is condensed, with the author's permission, from his "Handbook of Model Rocketry", 4th Edition (Follett Publishing Company, Chicago, 1976), the most complete book on Model Rocketry.

INTRODUCTION

One of the highest achievements in model rocketry is the construction and flight of exact replicas of full-sized rockets built to scale. Some rocketeers duplicate even the launching equipment so that their models lift off from scale launching pads.

Scale model rocketry is not something that can be done overnight. The construction often takes months. It is important to (a) select a good subject, (b) get adequate data, (c) prepare accurate working drawings and calculate CP and CG, (d) select the right size and propulsion, (e) build three identical models at the same time so that you will have a test model and a spare, (f) take your time and (g) make a flight test so you will know how it performs.

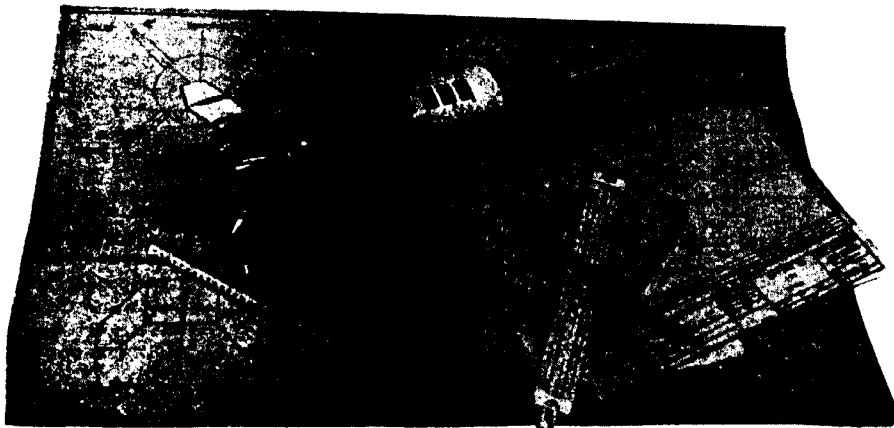

Scaling the Little-Joe II from General Dynamics/Convair dimensioned drawings.

SELECTING A SCALE MODEL

You should not select a prototype that requires construction beyond your abilities, or will be difficult to build. Select a simple straightforward prototype first . . . something like IRIS, HONEST JOHN, NIKE SMOKE, TOMAHAWK, ASP.. It is not wise to choose a first scale model that requires clear plastic fins to fly. Your first scale model should be a single-staged vehicle with a cylindrical body, a simple nose cone, and plenty of fin area at the rear of the rocket.

The local library is a good place to start. Many books have been published, full of photographs and simple drawings of rocket vehicles. The National Association of rocketry has drawings of scale models available to members through NAR Technical Services. Several manufacturers produce scale and semi-scale kits (semi-scale model is one that resembles very closely a given prototype but is not an exact replica.) Once you have selected a vehicle, you must obtain enough information to build a scale model of it.

OBTAINING SCALE DATA

It is the responsibility of the modeller to provide substantiating information to prove that he has built a scale model. Obtaining scale data often takes time . . . lots of it. And it takes a lot of letter writing. You may have to be persistent and stubborn, while remembering your manners and keeping in mind that you are asking people to do something they do not have to do. Find out who makes the vehicle and who uses it. Write a letter directly to the user or manufacturer, and include the following:

- Why you want the information.
- What vehicle you wish information about.
- The exact nature of the information you want -- photograph, dimensioned drawing, etc.

Do not ask for "all information, drawings, etc.". You won't get them. It may take

several weeks to get an answer. If you don't get a reply within four weeks, send another letter. Your first inquiry may result in nothing more than a pretty brochure which contains no useable information. Don't give up. Write again, thanking them for the brochure and asking for specific information.

Your letter should be typed on clean, white paper and include your complete return address. Don't scrawl a pencilled note on a scrap of old notebook paper. Your results will often depend upon the appearance, neatness, spelling, and grammar of your letter.

The minimum scale data that you should have is listed here:

- At least one clear photo of the vehicle.
- A dimensioned external drawing.
- A color photograph showing paint pattern or a letter telling what the paint pattern was on the real rocket.

The scale data need not be original copies. It is sometimes possible to obtain scale data from a good professional or museum model. **BUT DON'T COUNT ON IT!** Very few museum models are accurate.

You should build a model of one particular vehicle, unless the vehicle was manufactured on a production line. For example, every one of the 14 Viking rockets launched was different. A scale model judge may ask "Which serial number is this?" Don't try to fool anybody; somebody will nail your hide to the wall for it. Know your facts.

DESIGNING THE SCALE MODEL

Now you've got your scale data and have put it all together in a nice, labelled note book. Calculate the C.P. location of the prototype using the Barrowman Method (found in Centuri's TIR-33) and put the calculations in the notebook for reference later.

You will probably be using an existing commercial body tube. Remember that larger scale models generally fly better than smaller models, and it is easier to put all the details on. Do not let it become so large that it is overweight and underpowered!

Having chosen a body tube size, next determine the exact size and scale of your model. Reduce all of the dimensions of the prototype by the same amount so that everything will be in proportion on the scale model. Determine the ratio between the diameter of the prototype and the diameter of the body tube of your model. This is done by dividing the diameter of the prototype by the diameter of the model. If the number comes out as 18.2, for example, it means that the scale of the model is 1 to 18.2 ; one inch on the model equals 18.2 inches on the prototype. In scale model rocket work, we usually work in inches and decimal parts of an inch, it's much easier than using fractions.

The actual construction and craftsmanship is up to you . . . Good Luck!



Ideas:

Two Plans

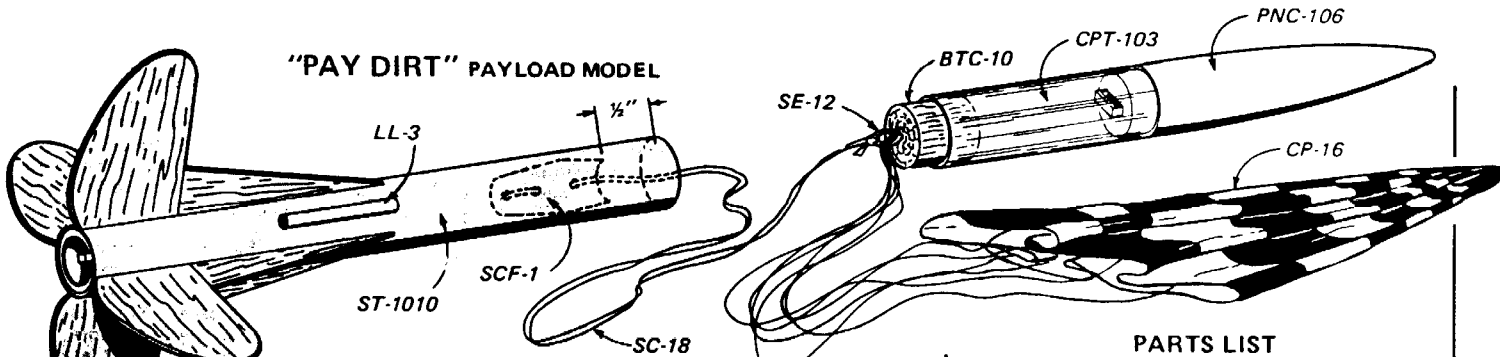

"PAY DIRT" PAYLOAD MODEL

PARTS LIST

1 ST-1010	10" Body Tube
1 EM-10A	Engine Mount
1 EL-1	Engine Lock
1 LL-3	Launch Lug
1 BFM-10	Balsa Sheet (3/32")
1 BTC-10	Balsa Tube Coupler
1 PNC-106	Nose Cone
1 CPT-103	Payload Tube
1 CP-16	Parachute
1 SC-18	Shock Cord
1 SCF-1	Shock Cord Fastener
1 SE-12	Screw Eye

Use paint and decals of your choice.

1 Glue thrust ring into end of engine mounting tube. Slit tube for engine lock.



2 Assemble engine mount with modification for engine lock as shown at right.

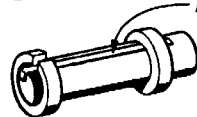

3 Mark 4 fin locations on an ST-1010 tube, using this guide, and extend the lines as explained on page 11.

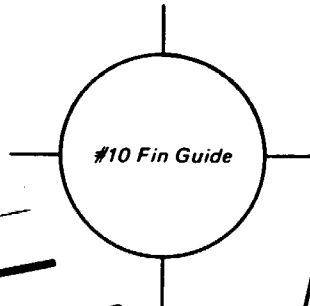

4 Glue engine mount into body tube as illustrated.

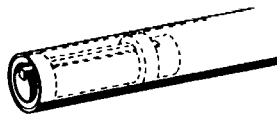

5 Using fin template, mark fins on balsa sheet as shown.

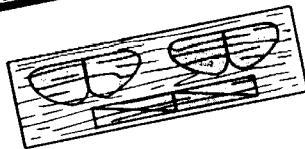

6 Glue the 2 fin pieces together to form completed fin. Check alignment against straight edge.



7 Glue fins to body. Attach launch lug and shock cord.

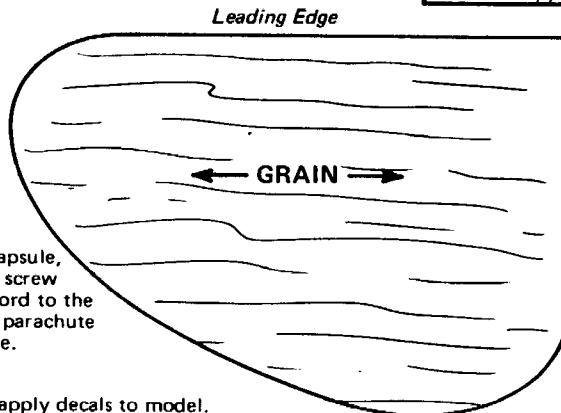

8 Socket tube coupler, payload capsule, and nose cone together. Attach screw eye and the free end of shock cord to the base of tube coupler. Assemble parachute and tie shroud lines to screw eye.

9 Sand and finish fins. Paint and apply decals to model.

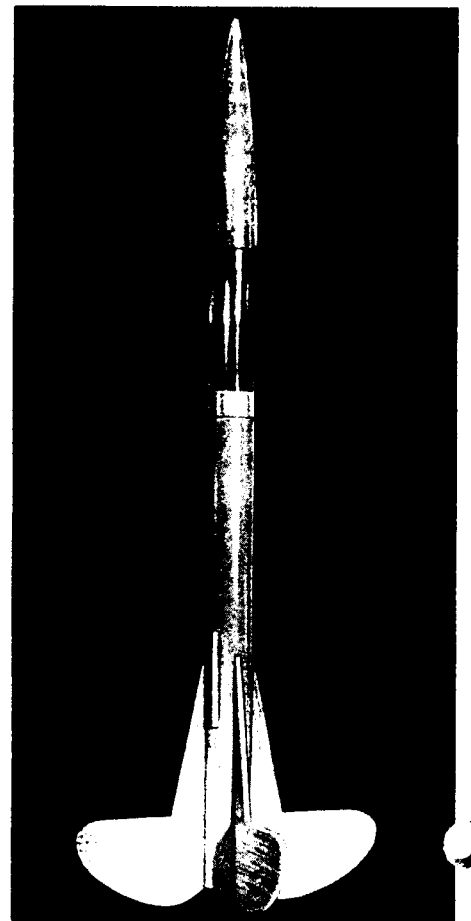

Fly the Pay Dirt with the following engines:

A8-3 B4-4 B6-4 B14-5 C6-5

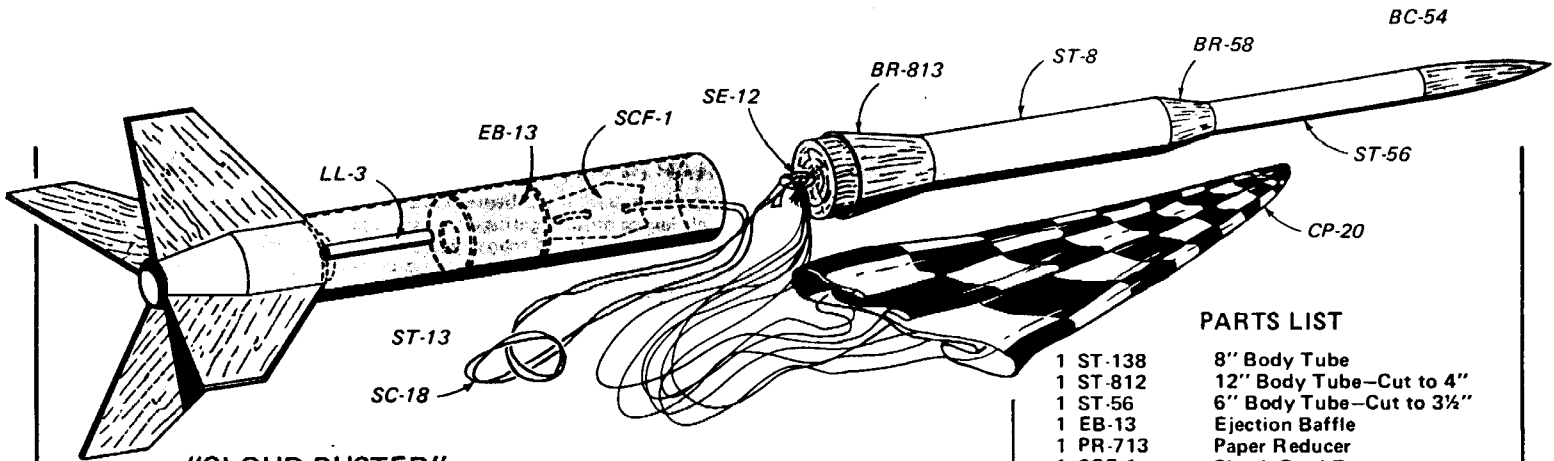

"CLOUD-BUSTER" SPORT MODEL

PARTS LIST

- | | |
|----------|-------------------------|
| 1 ST-138 | 8" Body Tube |
| 1 ST-812 | 12" Body Tube—Cut to 4" |
| 1 ST-56 | 6" Body Tube—Cut to 3½" |
| 1 EB-13 | Ejection Baffle |
| 1 PR-713 | Paper Reducer |
| 1 SCF-1 | Shock Cord Fastener |
| 1 BFM-10 | Balsa Sheet (3/32") |
| 1 CP-20 | Parachute |
| 1 BC-54 | Nose Cone |
| 1 BR-813 | Balsa Reducer |
| 1 BR-58 | Balsa Reducer |
| 1 LL-3 | Launch Lug |
| 1 SE-12 | Screw Eye |
| 1 ST-73 | Engine Mounting Tube |
| 1 TR-7 | Thrust Ring |
| 1 SC-18 | Shock Cord |

Use paint and decals of your choice.

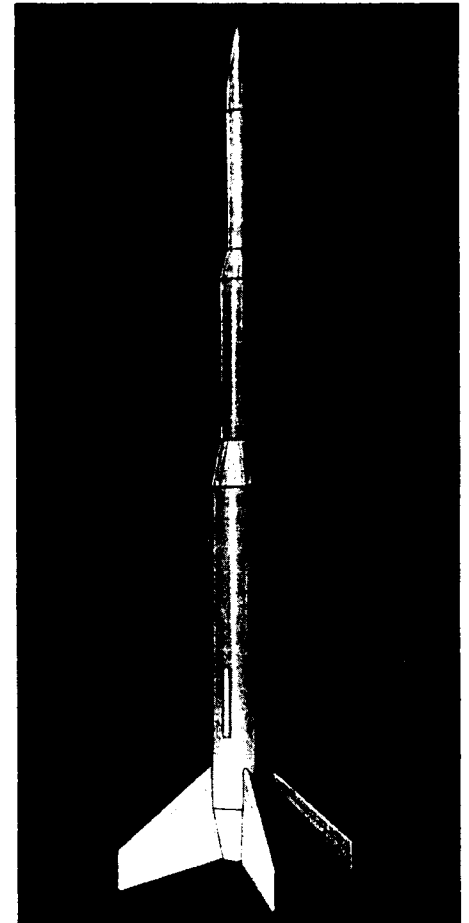

Fly the Cloud Buster with the following engines:

- A8-3 B4-4 B6-4 B14-5 C6-5

1 Assemble the two segments of the paper reducer (PR-713).



2 Glue thrust ring into end of engine mounting tube.

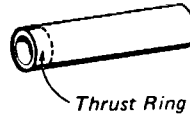

3 Glue engine tube into the sleeve mount of the PR-713. Now glue paper reducer over exposed portion of engine tube.

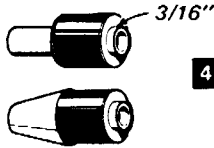

4 Mark fin locations on ST-138.

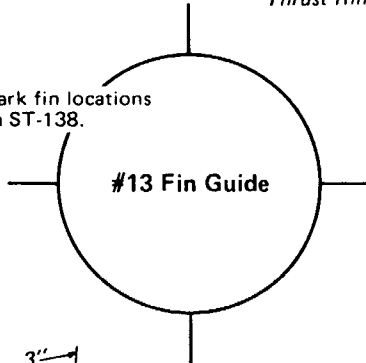

5 Glue engine mount into body tube. Try to line the reducer seam with one of the tube lines.



6 Assemble ejection baffle and place into body tube. Secure with glue bead at front.

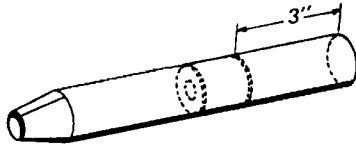

7 Using fin template, mark fins on balsa sheet as shown, and cut out neatly.

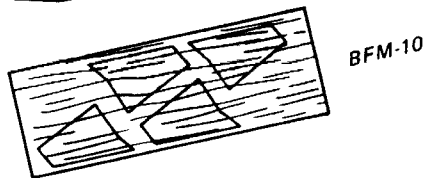

8 Attach fins, launch lug and shock cord.

9 Finish balsa parts, paint and apply decals.

10 Cut #5 and #8 body tubes to length, socket tubes and reducers together to form upper body. Attach screw eye to BR-813. Assemble parachute. Attach chute shroud lines and free end of shock cord to the screw eye.

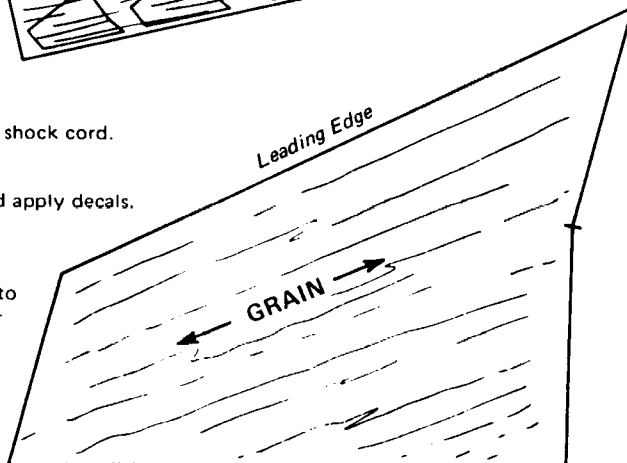



Ideas: Styling

INTRODUCTION

There are countless ways to individually stylize and personalize your own-design rockets. The ideas shown here should get your imagination going. NOTE: Centuri does not have plans available for these designs, but we encourage you to design your own.

BODY DIAMETER VARIATION

Solid balsa reducers, plastic reducers and hollow paper reducers can be used to keep your design from being a "straight shaft." Reducers are in the Centuri catalog. Instructions for cutting your own paper ones are on page 13. The SP symbol indicates Separation Point.

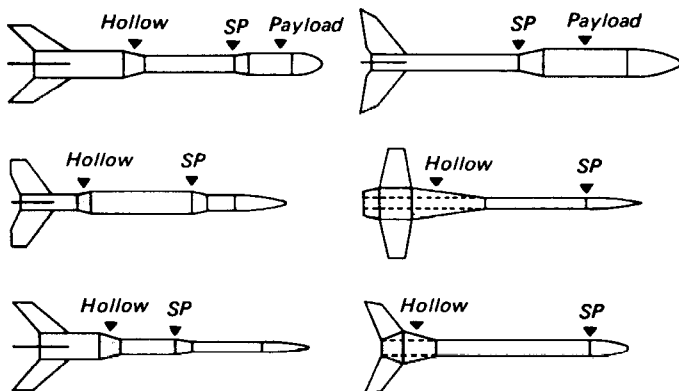

PODS & SCOOPS

Standard tubes and cones can be used creatively for futuristic effects.

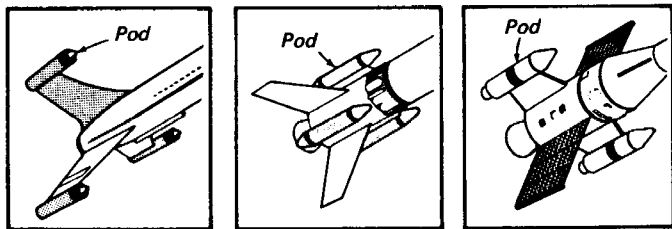

VANES & FORWARD FINS

Small "fins" and strips may be added toward the front, IF they are not so big as to cause instability.

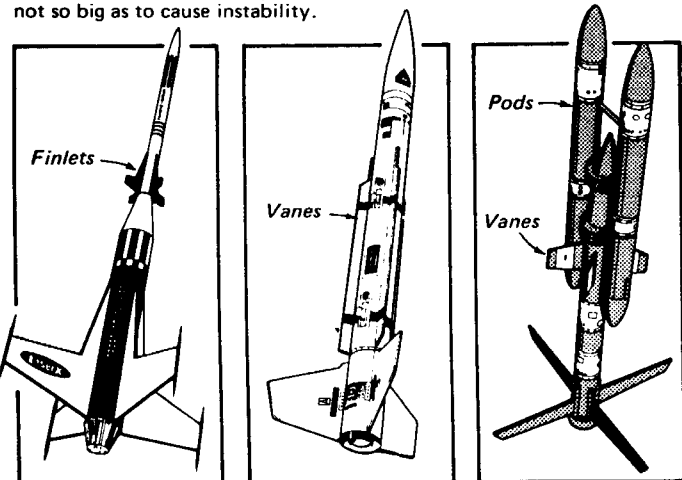

SCRAP PLASTIC KITS

Do you have several old beat-up plastic car and plane models laying around gathering dust? Look them over and you may find many little plastic "widgets" that can be contact cemented to your rocket... adds a super realistic touch. Plastic car kits are the best source because of all the automobile engine parts.

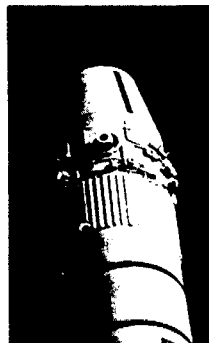

Modified "Orion"



Detail of "OK-70"

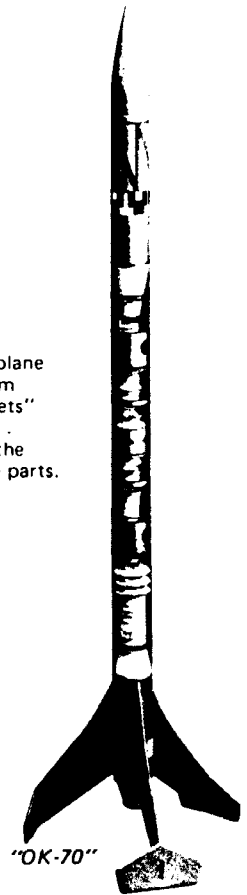

"OK-70"

Uses clear plastic body tubes, also.

HOLLOWED BALS

1. Apply sheet of paper onto two 3/4" thick balsa planks with thin layer of white glue.
2. Allow to dry thoroughly.
3. Glue paper sides of planks together.
4. Carve & sand hull to shape.
5. Pry the planks apart.
6. Hollow out interior.
7. Install body tube & engine mount.
8. Make nose detachable.
9. Glue halves together again.
10. Complete assembly with balsa fins and filler material.

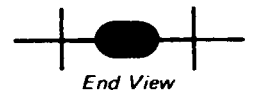

End View

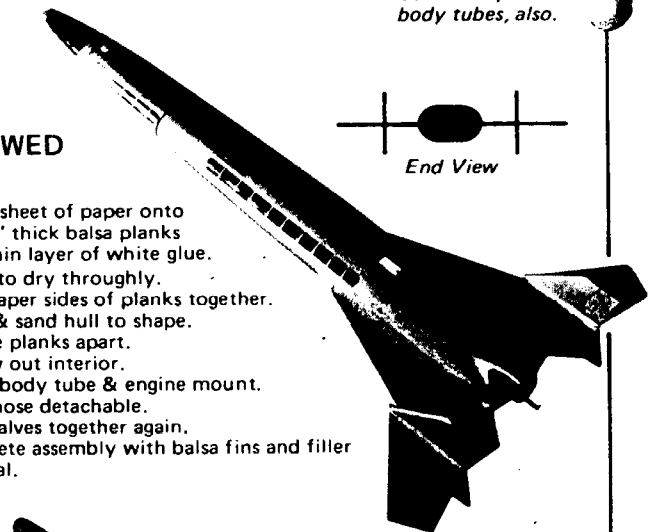

PLANKED BALS

1. Employs standard model airplanes construction techniques.
2. Plan geometrically by drafting.
3. Attach formers to a narrow body tube used as a core.
4. Glue 1/8" thick sheets onto formers to form skin.
5. Round all edges and fill seams.

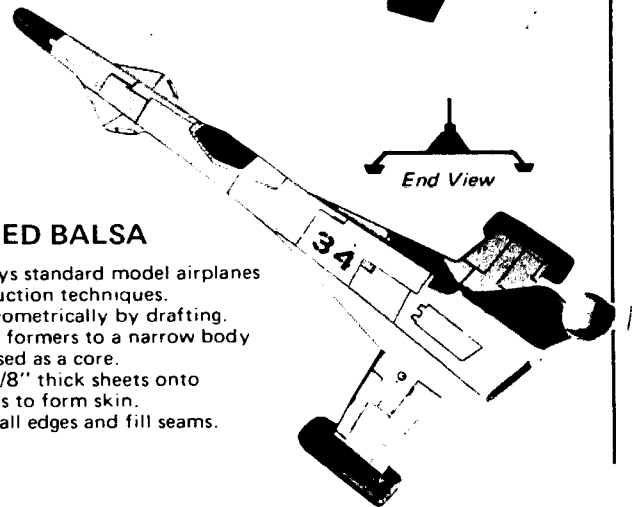

End View

Ideas: Materials

INTRODUCTION

There are countless ways to use unusual materials in constructing own-design model rockets. There is no rule about what's "right" to use, except the obvious one which is the first part of the Rocketeer's Safety Code:

CONSTRUCTION — My model rockets will be made of lightweight materials such as paper, wood, plastic, and rubber without any metal as structural parts.

You are limited only by your imagination and budget! Here are several ideas to get you started in experimenting.

BALSA

This fantastic wood is nature's gift to aero modelers . . . without it there might never have been a model rocket or model airplane hobby. Balsa is obtained from very large trees which grow in wet tropical forests . . . chiefly in Central America and Southeast Asia. Surprisingly enough, balsa is technically considered a hardwood. Many parts of a balsa tree are harder than mahogany! The modeler's chief interest in balsa is its extremely high ratio of strength to weight, and its ease of being shaped.

Balsa is readily obtained at most craft and hobby shops, and many large department stores. It generally comes in three foot lengths in the form of strips, sheets and planks. Available in many combinations of dimensions, the strips range from 1/32" x 1/32" up to 1" x 1", while the sheets and planks are 3" or 4" wide; again in various thicknesses. Leading and trailing edges for airplane wings are also available and sometimes have applications in model rocketry.

Strips are useful for surface detail. Sheet balsa is ideal for fins. Here is a "rule of thumb" chart for choosing balsa fin thickness (you may use your own judgement in choosing thicker or thinner sheets, as we have done with some of our kits).

THICKNESS	APPLICATION
1/32"	Hollow built-up fins
1/16"	Standard small rockets
3/32"	Standard medium rockets
1/8"	Large rockets or clusters
3/16"	Large clusters
1/4"	Generally too thick; high drag

The last three thicknesses are also desirable for use with engines greater than "C" power.

Plank balsa is useful for carving exotic hulls as shown on the previous page. The most common use of plank is in creating unique nose cones, reducers and boat tails. Here are some examples:

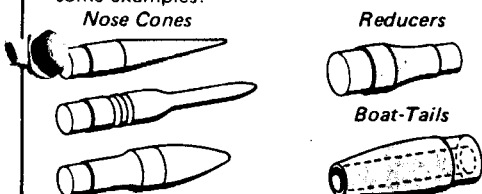

HOW TO TURN BALSA

STEP 1 Select a piece of balsa that is at least 1/8" larger in cross-section and at least 1/4" longer than the desired cone or part.

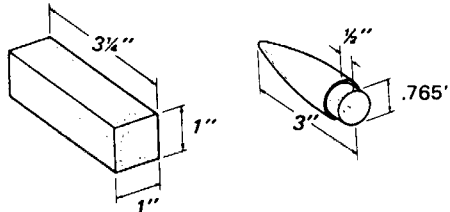

STEP 2 Drill a 1/4" dia. hole to a depth equal to one-half the length of the cone, into the center of the one end. Locate the center by drawing diagonal lines across the block end. Be sure to drill the hole parallel to the sides of the block, for easier turning.

Squirt glue into the hole and push in a 1/4" hardwood dowel long enough so that it extends out 2 1/2" to 3" when fully inserted. Allow the glue to dry thoroughly before proceeding, to the next step.

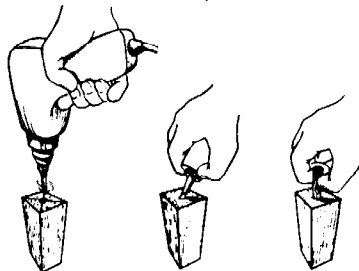

STEP 3 Carve the piece roughly to shape to remove excess material.

STEP 4 For turning, use an electric drill locked in a vise, or a lathe, or improvise by attaching a drill chuck to a 1/4HP electric motor. Fasten the wood dowel into the chuck - close up the chuck face. Using fast rotation on the chuck, use coarse sandpaper or a wood file to form the desired cone shape. Finish sand with fine sandpaper down to the O.D. of the body tube, then form a short shoulder section to fit the I.D. of the body tube. As you approach the final shape, periodically remove the piece to test-fit it into your tube.

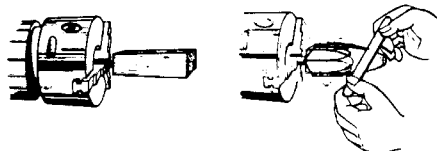

STEP 5 After the cone has been completely shaped, cut off the extending dowel with a fine-tooth saw as shown.

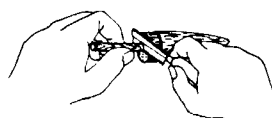

CARDBOARD & PAPER

Centuri has pioneered the use of special cardboards as fin material. Easy to paint and requiring no sand n' seal, it speeds up construction. Illustration board (which is about 1/16" thick) makes an excellent fin material for many applications. You can experiment with unusual fin shapes, without worrying about grain direction as with balsa fins. Avoid swept back shapes, which may crumple at touchdown.

Experimental Fin

Avoid Swept Fins

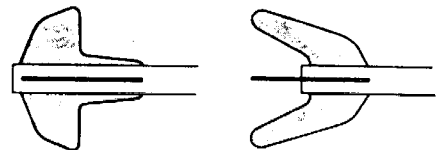

Thinner cardboards, such as Bristol, Tag, or Index, are great for folded fins and hollow built-up types of fins.

Folded

Built-Up

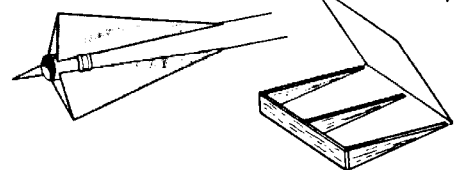

PLYWOOD

Thin sheets of plywood are available in model airplane departments of hobby shops. Though harder to shape and finish, plywood is great for fins subjected to high stress; such as with clusters, stages, or engines greater than "C" power.

SPECIAL MATERIALS

Basswood is a strong, fine-grained wood which comes in a great variety of tiny structural shapes. Found in model railroad departments, it is great for display "launchers" and detailing on scale rockets.

Plastruct is extruded plastic which comes in structural shapes similar to basswood.

Dowels are available in diameters as small as one twelfth inch . . . these are handy for fin reinforcing and body braces.

Glue comes in a wide variety; each has its uses:

WHITE GLUE, ALIPHATIC (WILHOLD) is the best all-purpose glue for joining wood and paper together.

PLASTIC CEMENT in liquid or tube form is best for joining styrene plastic parts to each other. It is a solvent which actually melts and "welds" the plastic.

CONTACT CEMENT is used for joining parts which are otherwise un-bondable: plastic to paper, parts onto painted surface, vacuum-formed plastic parts to each other.

EPOXY is generally unsightly but is handy for quick field repairs because it dries fast and strong.



Ideas: Displays

INTRODUCTION

There are many ways to effectively display your rockets. Centuri's ROCKET-RACK kit shown here is one of the simplest! Display stands are also useful for showing off those rockets which can't stand upright on their fins.

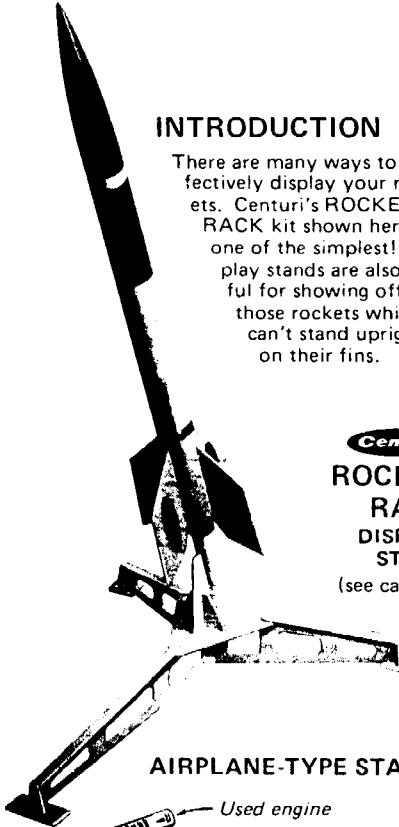

Centuri
ROCKET RACK DISPLAY STAND
(see catalog)

AIRPLANE-TYPE STAND

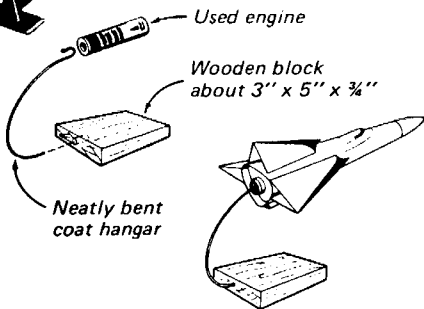

Used engine

Wooden block about 3" x 5" x 3/4"

Neatly bent coat hanger

UPRIGHT STANDS

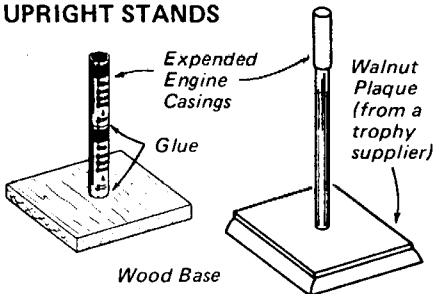

Expendable Engine Casings

Glue

Walnut Plaque (from a trophy supplier)

Wood Base

PEGBOARD DISPLAY

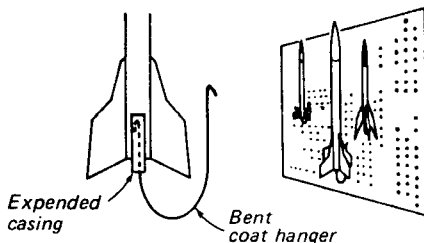

Expendable casing

Bent coat hanger

DISPLAY LAUNCHERS

Display "launchers" are just what the name says: DISPLAY. They are not intended for actually launching your rockets. We do not have plans or kits of these "launchers" available. Every rocket requires a display launcher custom designed to fit the rocket.

The display launchers shown were built from common materials in our R & D shop for special press release photos. Our source of data was simply photos we found by researching the local library. You too can find books containing this type of photo by asking your librarian to help you use the library's index file.

This SCRAM-JET rests on a "launcher" similar to those found on U. S. Navy missile ships.

The rack and turret use short body tubes internally to allow realistic movement.



Both "launchers" shown here are improvised from illustration board, index stock, and body tubes. Decorative pieces were added.

The NOMAD here is "poised for launch" on another naval type launcher. Note the use of thin poster board shapes glued on top of each other to create surface details and structural effects. Decals and small "widgets" were salvaged from old plastic kits of ships and planes. Red and white numbers look especially handsome against the light gray paint.

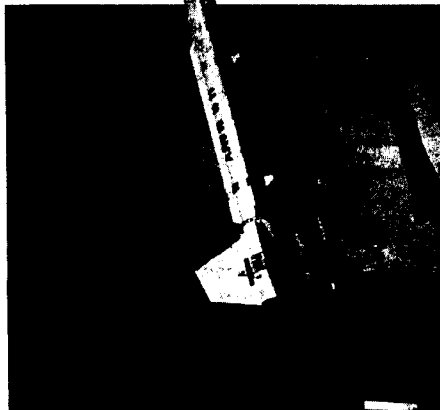

FUNCTIONAL DISPLAY LAUNCHERS

The rocket shown below rests upon a rather typical home-made display launcher . . . but as seen in the top photo, it really works!

Special precautions must be taken in designing and building your own realistic launch stand:

1. Be sure you have the required three feet of guidance. This can be a standard launch rod, or a rail or track.
2. Use a large enough deflector to protect flammable paper, plastic and wood parts from the engine's flame. The deflector also functions as a "heat-sink" which absorbs heat into itself, rather than allowing surrounding parts to become hot. Use steel (such as from a large "tin" can) rather than aluminum, which melts too easily.
3. As a model rocket lifts off, it occasionally pulls or throws the igniter leads violently. Arrange your igniter leads so they clear all fragile launcher parts.
4. Design your launcher to allow a variety of rockets with different length and diameters to be used upon it.

The style shown here meets all the above criteria. The umbilical tower on the right is decorative only . . . it is unhooked before launch. A standard launch rod is inserted just before launch, but left out while the unit is on display against its backdrop.



Odds & Ends

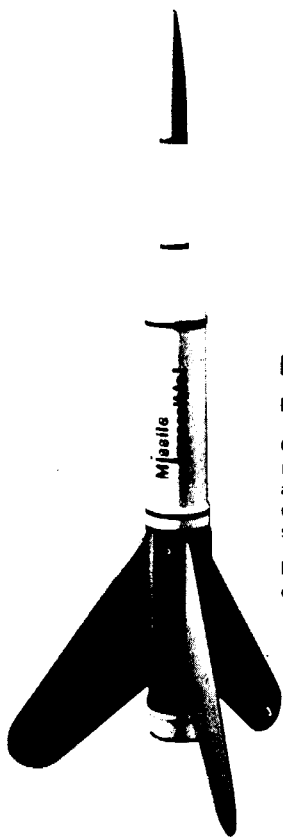

MISSILE IMPOSSIBLE

No idea is too impossible in model rocketry, if properly executed.

Charles Ash of Glendale, Arizona designed and built this incredible rocket which seems to "destroy" itself at peak of flight. Actually, a clever system of a piston and exhaust ports uses the engine's ejection charge to cause instant dis-assembly. All pieces recover safely to be used again.

Not only is the design workable, but it has the finest model rocket craftsmanship we have seen outside our R & D shop.

The diagram at the right shows how complex this design is. Project such as this one require much care and thought.

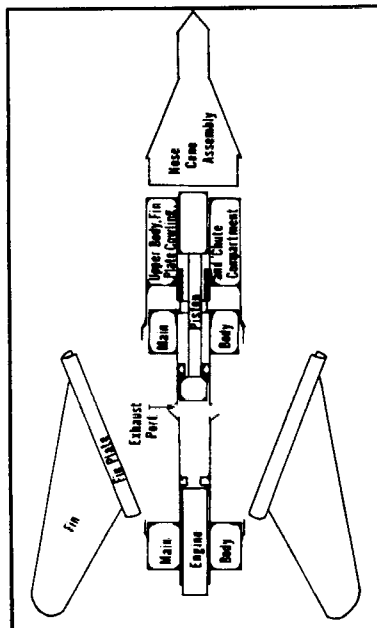
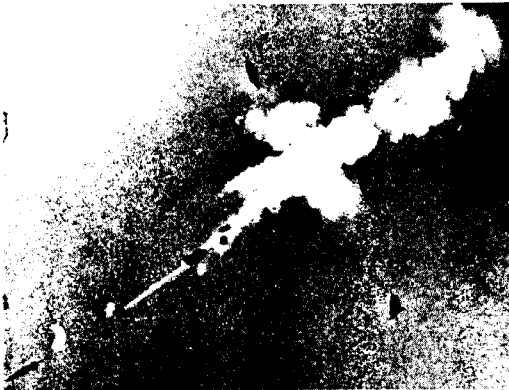

PLASTIC KIT CONVERSION

Over the years most plastic kit manufacturers have produced scale display model kits of real rockets and missiles. Some of these are suitable to be converted to flying model rockets. Conversion is also an accepted event in many rocket competitions.

Conversions offer these design challenges:

- A. Avoid plastic melting from engines' heat.
- B. Solve stability problems; perhaps by adding clear plastic fins (many scale models have insufficient rearward fin area).
- C. Devise a reliable way for cone separation.
- D. Avoid weight problems (conversions tend to become heavy).

TYPICAL CONVERSION DETAIL

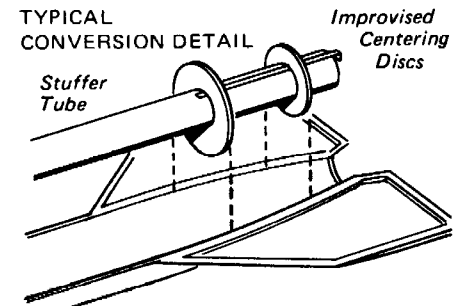

RESEARCH & DEVELOPMENT

R & D is perhaps the most creative area of model rocketry. Again, its a recognized event in many rocket competition.

Complete information is available in National Association of Rocketry publications, but here are a few guidelines:

1. Choose a topic.
2. Define the problem.
3. Research existing information.
4. Formulate theories.
5. Construct prototype equipment.
6. Conduct many tests.
7. Keep accurate records.
8. Come to a conclusion.
9. Prepare final report.
10. If possible, publish it so others may benefit from what you have learned.

There have been thousands of model rocketry R & D projects. Here are some typical popular topics:

- * Measured Altitude vs Predicted Altitude
- * Measuring How Payloads Affect Altitude
- * Measuring Aerodynamic Drag
- * Measuring Wind Speed and Drift
- * Ecological Applications of Model Rockets
- * Wind Tunnels for Model Rocketry
- * Alternatives to Tumble-Recovery Boosters
- * Engine Thrust Recording Device
- * Electronic Payloads & Telemetry
- * Model Rocket Aerial Photography
- * Reducing Drag by Shape Optimizing
- * Effects of Weather on Rocket Flight
- * Improved Altitude Measurement
- * Photographic Analysis of Flight
- * Alternative Launch Systems

NON-FLYING ROCKETS

Some rocketeers enjoy building scale model rockets which are not intended to be flown. The one below was done by carefully studying photos of the real thing, and applying a little artistic license. Such models are a good way to use up odd rocket parts you have laying around.

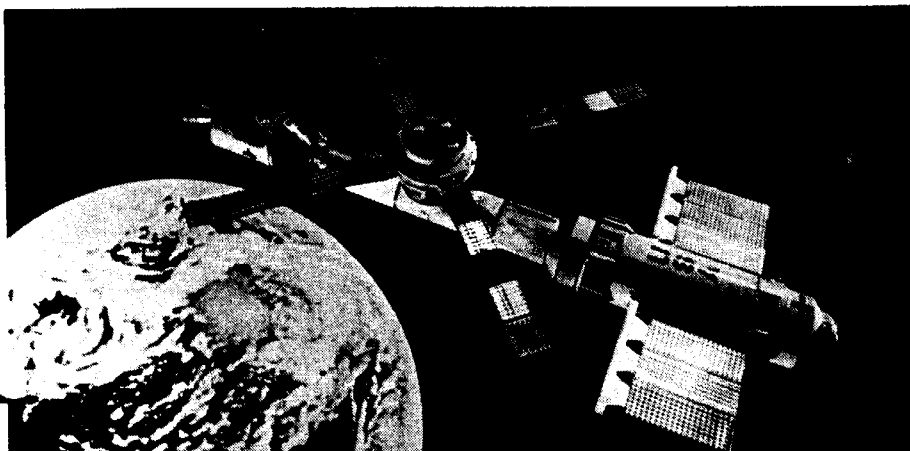

This fantastic display Skylab scale model was built by Vincent Bonkowski of Hamtramck, MI. He built it from scratch, using parts salvaged from various model rocket and plastic kits.

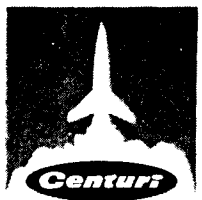

Rocket Info

These other publications are also available at your dealer or, order from: Centuri, Box 1988, Phoenix, AZ 85001. Be sure to enclose 85¢ for handling & postage.

Index

- Airfoil 6, 11, 22, 23
- Altitude 18, 19
- Angle-of-attack 4, 22, 23
- Balsa 28, 29
- Balsa Reducers 8, 9, 12, 28
- Boat Tail 6, 27, 28, 29
- Body Tubes 7, 8, 9
- Boost Glide 7, 22, 23
- Caliber 5
- Canard 22, 23
- Center of Gravity (CG) 4, 22
- Center of Pressure (CP) 4, 22
- Chord 6, 22
- Clip-Whip 24
- Clustering 7, 24
- Competition 7, 19
- Core Ejection 22, 23
- Components 8
- Connectors 8
- Couplers 8
- Cutting Body Tubes 10, 11
- Decalage 22
- Delta Wing B/G 7, 22
- Dihedral 22, 23
- Display Stands 30
- Dive 22, 23
- Egg Lofting 19
- Engine Classification 24
- Engine Mounts 6, 8, 9, 11, 20, 21, 24
- Engine Selection 18, 19, 21, 23, 24
- Ejection Baffles 8
- Fillets 12, 18, 24
- Filling, sealing 10
- Fin Guide 9
- Fineness Ratio 5
- Finishing 14, 23, 29
- Fins 6, 8, 11, 12, 18, 19, 23, 24
- Flap 5, 22, 23
- Flat Plate Lift 22, 23
- Frontal Area 6
- Fuselage 23
- Glue 10, 29
- Glue Fillets 12, 18, 24
- Gyro Recovery 7
- Making Nose Cones 29
- Mini-Engines 7
- Modeling Knife 10, 11
- Non-Flying Rockets 31
- Nose Cones 6, 8, 12, 13, 29
- Optimum Weight 18
- Laminar Flow 6
- Launch Lugs 8, 11, 18
- Painting 10, 14, 23, 29
- Paper Reducers 8, 9, 13, 28
- Parachutes 7, 13, 15, 21
- Parasite Glider 22, 23
- Payloads, 7, 12, 19, 26
- Performance 6
- Plastic Conversion 28, 31
- Pods 6, 22, 23, 28
- Pop-Pod 22, 23
- R & D 31
- Rear Ejection 18
- Recovery Systems 7
- Red Baron 23
- Reducers 8, 9, 28, 29
- Rocket Glider 22, 23
- Rudder 22
- Safety 3, 4, 5, 21, 23, 24
- Sanding 10, 11, 14, 23
- Scale Modeling 7, 16, 17, 25
- Shock Cords 8, 13
- Span 6, 22
- Spin Stabilization 5
- Stability 4
- Stabilizer 22
- Staging 7, 18, 20
- Stall 22, 23
- Streamers 7, 15, 21
- Swing Test 5
- Swing Wing B/G 23
- Techniques 13, 11
- Tools 10
- Trimming (Glide) 22, 23
- Tumble Recovery 7
- Variable Geometry 22, 23
- Wing 22, 23

ROCKETEER'S GUIDEBOOK By Col. Bruno Larsen

Just the answer for the aspiring rocketeer who wants to find out "what it is all about". The "Rocketeer's Guidebook" is a fact-filled, clearly written, reference which will fill an important place in your model rocketry library.

36 pages,
illustrated,
8½"x11".
Rev. 1968

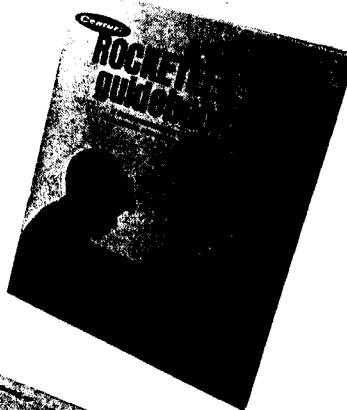

Rocketeer's Guidebook \$1.25

Prod. No. 81900

TIR-30 By Jim Barrowman STABILITY OF A MODEL ROCKET IN FLIGHT

You've probably heard that a stable rocket flight requires that the center-of-pressure must lie behind the center-of-gravity. Well, what is center-of-pressure? What does the word "stability" really mean? Are there any simple tests to tell if a new rocket will be stable? How come rockets head into the wind? These and many more important questions are fully answered in TIR-30.

16 pages,
illustrated,
8½"x11".
Rev. 1975



TIR-30 \$1.00

Prod. No. 81903

TIR-33 By Jim Barrowman CALCULATING THE CENTER-OF-PRESSURE OF A MODEL ROCKET

TIR-33 shows you how to calculate and locate the exact center-of-pressure so you can achieve maximum performance together with an adequate margin of stability. Helps to show if additional nose weight is necessary. Helpful in balancing scale birds with very little fin area. Fully illustrated, it includes all necessary equations; design tips plus sample problems, along with easy-to-use graphs which eliminate most of the tricky arithmetic steps.

36 pages,
illustrated,
8½"x11".
Rev. 1975

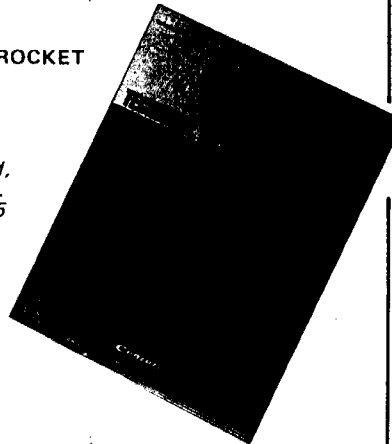

TIR-33 \$1.00

Prod. No. 81904

TIR-100 By Douglas Malewiewski MODEL ROCKET ALTITUDE PERFORMANCE

Predict the peak altitudes which will be reached by single stage rockets using 1/8A thru C type engines with easy-to-use graphs. Also more graphs for selecting the best engine delay time. No math calculations needed whatever. These graphs plus discussion sections will help you understand how engine thrust, rocket weight, and aerodynamic drag on various nose & body shapes are inter-related in their affects on performance.

40 pages,
illustrated,
8½"x11".
Rev. 1975

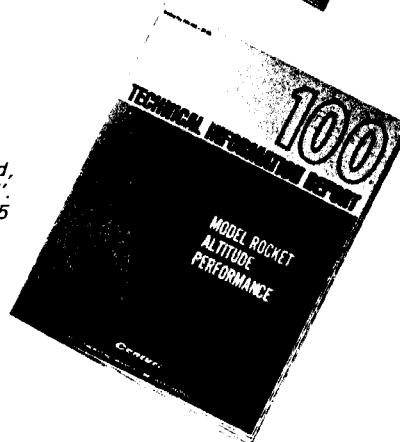

TIR-100 \$1.00

Prod. No. 81906