

MODEL ROCKET NEWS

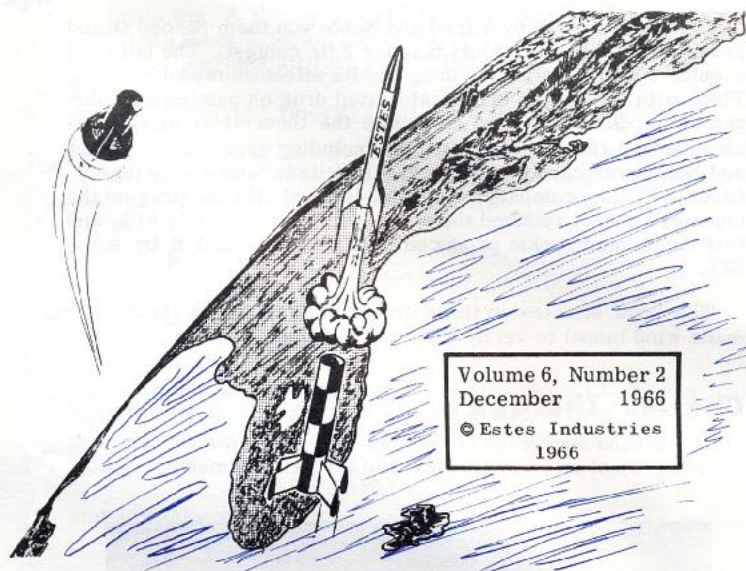

Volume 6, Number 2
December 1966
© Estes Industries
1966

Science Fair Results

James Dolan...

First Place in the Estes Science Fair Contest goes to James Dolan of Kingston, New York for this study of "Rocket Thrust Augmentation." His major area of work was augmentation by ducted propulsion.

James first established that the principle of thrust augmentation could be explained through the formula $F = ma$. "F" is thrust, "m" is mass moved in the rocket's exhaust, and "a" is acceleration. Thrust can also be expressed by the formula $F = \frac{I_t}{t_b}$ where "I_t" is total impulse and "t_b" is the duration of the thrust. He states further that: "If we consider the factors which influence total impulse, it will be evident what is needed to increase thrust."

Total impulse can be expressed as the product of the specific impulse of the rocket's reaction mass or propellant (I_{sp}) and the amount of the reaction mass (M_p). Therefore: $I_t = I_{sp} M_p$; where "I_{sp}" is the specific impulse, and M_p is the amount or weight of the propellant(s) or reaction mass. Since specific impulse is a measure of the efficiency of the rocket, and is based on several factors such as the velocity of the exhaust leaving the rocket. This factor may be improved by nozzle, fuel, and other refinements in the engine. However, it is desirable to employ pre-packaged engines in small rockets. For this and other reasons, it is sometimes more acceptable to increase the amount of reaction mass. Of course, only the reaction mass which is actually expelled from the rocket is useful.

A mock-up of an augmentation system was built first. Sev-

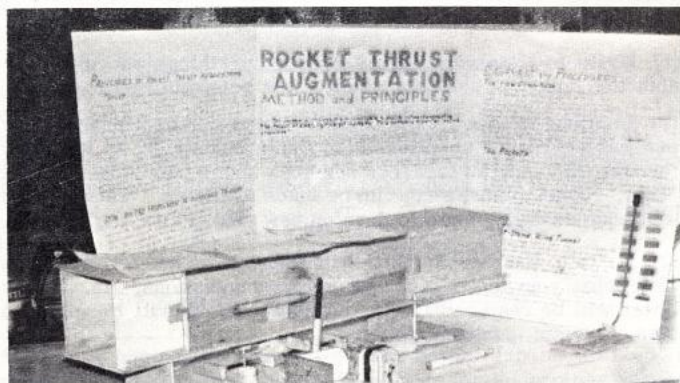

eral colored water dyes were used to indicate flow through the ducted propulsion system. These colors represented the gases. A clear plastic tube allowed observation of the flow. A siphon brought one color of water into the augmentor through a nozzle. Clear water replaced surrounding air. The workings of this system indicated to Jim that the rocket exhaust really accelerated the air in and around the augmentor tube.

Next, Jim used model rockets in a static environment to test the augmentation of thrust. The tests were made with both stagnant air and air in motion to simulate actual flight. The model rockets were attached to a thrust recorder to measure thrust throughout the engine run.

In summary, Jim noted that no appreciable increase in thrust was achieved through ducted propulsion.

Alfred & Noble Newberry...

Alfred Newberry of Moody, Missouri, and Noble Newberry, Hocomo, Missouri, shared the first runner-up position with their studies on "What are the effects of Drag caused by Surface Friction?"



The studies made by Alfred and Noble won them Second Grand prize in the Rolls, Missouri Science Fair contest. The boys did a quite complete study on drag and its effect on model rockets. They, with the help of math, calculated drag on painted and non-painted birds. They also computed the theoretical (drag free) altitude and the probable altitude including drag. Then Alfred and Noble compared the theoretical altitude with the actual altitude. In this comparison it was learned that the drag on the unpainted rocket reduced the altitude by approximately 91%, and that the painted rocket produced drag that impaired it by some 82%.

The boys also tested these drag relationships in their home made wind tunnel to verify their airborne data.

Charles Theroux...

The second runner-up is Charles Theroux of Woonsocket, R.I. for his project on "Acceleration and Its Measurement".

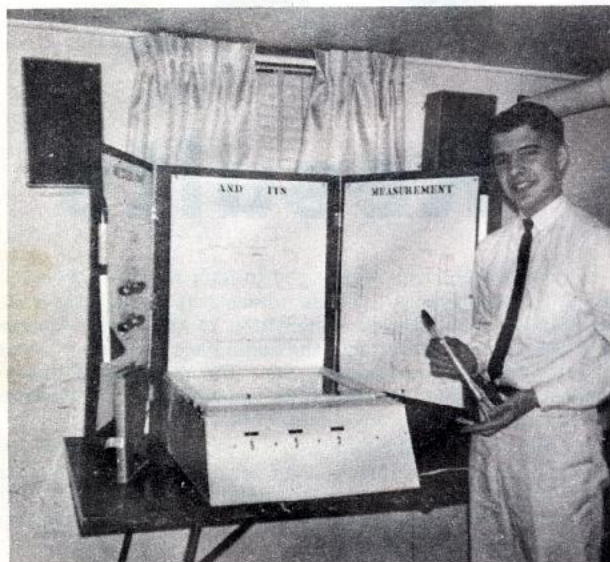

In order to conduct his studies Charles had to develop an accelerometer and a centrifuge. Charles is shown in the photo with his display. The second photo shows the centrifuge, which was made from a bicycle wheel and placed in a viewing box for safety purposes.

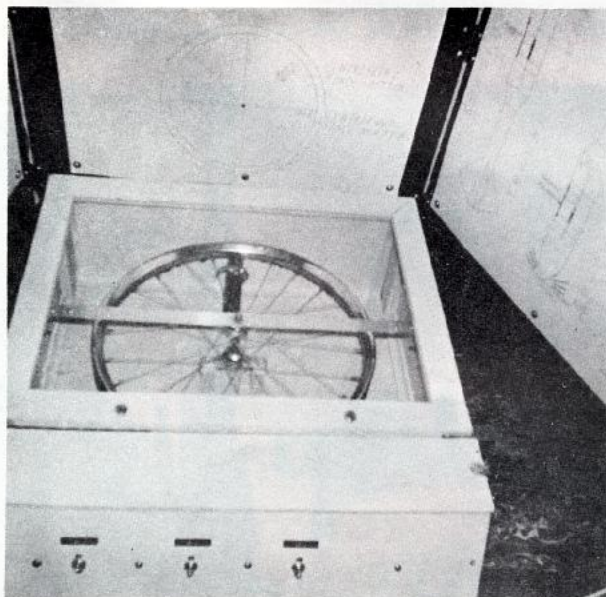

The accelerometer was constructed from a cardboard body tube, a spring and a disc with tissue paper covering. Chuck, in his report stated: "...although simple, this instrument would

show approximately how much acceleration would take place within the rocket."

John W. Ludeman...

Third runner-up in the Estes Science Fair is John W. Ludeman of Lanham, Md., for his study of "Parawing Glider Systems".

For several years the government space agency has researched methods of recovery using the "Rogallo" wing, also the parawing for space boosters and capsules. John took these government studies and adapted them to use in model rocketry.

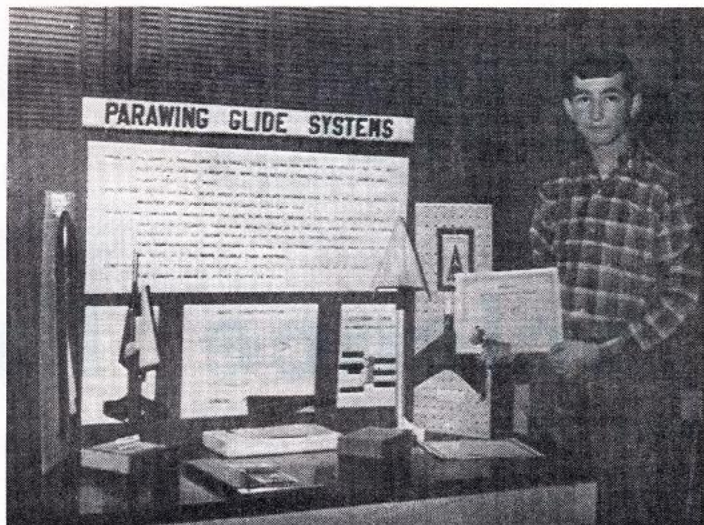

Sophomore John Ludeman surveys his prize-winning science fair project and certificate.

The project took almost a year, thirty-five flights, and many wing designs before John could draw any conclusions from the project.

John was able to achieve a flight duration of 73 seconds with an A.8-3 engine powering his test model. Using the data from the test flights he came to this conclusion: "After having studied the data it is my opinion that para-wings are quite well suited to model rocketry and can out-perform most conventional boost gliders by a wide margin when properly built." John also determined from his study that a para-wing swept back at 45 to 55° gave the best flight with the longest duration.

MODEL ROCKET NEWS

The Model Rocket News is published by Estes Industries, Inc. Penrose, Colorado. It is distributed free of charge to all the company's mail order customers from whom a substantial order has been received within a period of one year. The Model Rocket News is distributed for the purpose of advertising and promoting a safe form of youth rocketry and for informing customers of new products and services available from Estes Industries. Rocketeers can contribute in several ways towards the publication of the Model Rocket News:

- (1) Write to Estes Industries concerning things you and your club are doing in this field which might be of interest to others.
- (2) Continue to support the company's development program by purchasing rocket supplies from Estes Industries, as it is only through this support that free services such as the Model Rocket News, rocket plans, etc., can be made available. This support also enables the company to develop new rocket kits, engines, etc.
- (3) Write to the company about their products and tell what you like, what you don't like, new ideas, suggestions, etc. Every letter will be read carefully, and every effort will be made to give a prompt, personal reply.

Vernon Estes
Publisher

Gene Street
Illustrator

William Simon
Editor

Advanced Drag Calculations

by Douglas J. Malewicki

A new technical report which should be of special interest to all is just now coming off the Estes Industries printing press. It is entitled "Model Rocket Altitude Prediction Charts Including Aerodynamic Drag." A sample of its contents is presented in this issue of the Model Rocket News. Using this report model rocketeers can quickly and accurately estimate peak altitudes for their birds.

Once you see how easy it is to use, we are sure you will want the complete report for your library. In addition to the data presented here to work the sample problem, the complete report contains charts for all the other model rocket engines produced by Estes Industries. It also shows how to use the charts with clustered motors, how to include launch altitude and temperature effects, and how multiple stage rocket altitudes can be computed.

You will see by the sample problem that no higher mathematics is required. However, for those interested in the mathematical basis for the charts we have also included in the report the complete derivation and closed-form general solution obtained by integrating the non-linear differential equation of rocket motion. Back in the June, 1965 issue of the Model Rocket News (Volume 4, Number 2) this same equation was used for determining the true altitude (including drag) of a one ounce rocket using an A.8-4 motor. However, at that time we laboriously solved it by using a step-by-step small time increment method and weren't aware what the powerful mathematical tool of calculus could do for us.

Finally, the report contains suggestions for many drag experiments which are quite interesting and yet very simple. OK --let's get to our sample problem!

The key to these charts is the use of the ratio $\frac{W}{C_D A}$. This is rocket weight (W) divided by the product of the aerodynamic drag coefficient (C_D) and the body tube cross section area (A). This ratio is called the ballistic coefficient β , (the Greek letter BETA) and it is used by aerospace engineers as a trajectory parameter for space vehicles that are re-entering the atmosphere. A space vehicle having a high ballistic coefficient will come through the atmosphere faster than one with a low ballistic coefficient for a given set of initial reentry conditions. With the charts you will find that for our model rockets we too get better performance with higher ballistic coefficient values for our vehicles. This will become clear as we proceed with the sample problems.

Assume we have a rocket that: 1) weighs 1 ounce including engine, 2) is powered by an A.8-4 engine, and 3) uses a BT-20 body tube. The 1966 Estes catalog gives the diameter of the BT-20 body tube as 0.736 inches. This gives us a cross section area (A) of 0.425 square inch (the report contains a chart to eliminate area calculations so we won't go through the details here).

An aerodynamic drag coefficient of $C_D = 0.75$ will be used. G. H. Stine's Handbook of Model Rocketry presents this value on page 94 and also explains why it is considered valid.*

Next we compute the ballistic coefficient to be used during powered flight. During the thrusting phase the average weight of the rocket will equal the initial weight (W_I) minus one half the weight of the propellant ($\frac{1}{2}W_P$). The chart for the A class engines states the value of $\frac{1}{2}W_P$ as 0.0675 ounces. Thus the ballistic coefficient to be used during thrusting is:

$$\beta = \frac{W_I - \frac{1}{2}W_P}{C_D A} = \frac{1.0 - .0675}{(.75)(.425)}$$

$$\beta = \frac{.9325}{(.75)(.425)} = 2.92 \frac{\text{ounces}}{\text{inch}^2}$$

* We are hoping now that drag information can be utilized in such a simple way that knowledge of drag for many other shapes will become important enough to stimulate a lot more research on the subject.

From the "A Engine Chart" we find that for a ballistic coefficient (β) of 2.92 and an initial weight (W_I) of 1.0 ounce that Burnout altitude (S_B) = 150 feet

and

$$\text{Burnout velocity (V_B) = 310 feet per second}$$

During coasting we should use the empty weight of the rocket (initial weight (W_I) minus all the propellant weight (W_P)) to determine the correct ballistic coefficient (β). This will be:

$$\beta = \frac{W_I - W_P}{C_D A} = \frac{1.0 - 0.135}{(.75)(.425)}$$

$$\beta = \frac{.865}{(.75)(.425)} = 2.71 \frac{\text{ounces}}{\text{inch}^2}$$

Using the "Coasting Chart" for a rocket having a coasting ballistic coefficient of $\beta = 2.71$ and a burnout velocity of $V_B = 310$ feet per second we find that the rocket would coast up an additional distance of:

$$S_C = 550 \text{ feet}$$

and will take a time of:

$$t_C = 5.0 \text{ seconds}$$

from burnout to reach its maximum height. The total altitude that this rocket reaches is the sum of the altitude gained while thrusting (S_B) and the altitude gained during coasting (S_C), or

$$S_{\text{Total}} = S_B + S_C = 150 + 550 = 700 \text{ feet}$$

Those of you who have the June, 1964 issue of Model Rocket News will note that the altitude found for this rocket without considering drag was 2600 feet (greater than a 300% error).

You may also wonder why the complicated 1964 calculations showed that an altitude of 750 feet was reached, whereas our new chart method shows it only reached 700 feet. This is all due to neglecting the seemingly small amount of propellant that is burned off as we did in the 1964 calculations. If we go through the sample problem again and don't include any weight loss we will find that the rocket goes up to 750 feet just as the 1964 calculations said it would.

Now let us take a quick look at some of the effects "streamlining" can have for this same rocket. Suppose we have two people build this same rocket. Bill's is unpainted, unsanded, and the fins are square. Carl's, on the other hand, has a beautiful, smooth paint job, is fully waxed and has fins with a nice, streamlined airfoil shape. For comparison purposes, let's assume Bill's aerodynamic drag coefficient has increased 20% over the $C_D = .75$ we previously used (Bill's C_D now equals .9) and Carl's drag coefficient has been reduced by 20% (Carl's C_D now equals .6). Going through the same steps of the sample problem you will find Bill's rocket will reach 640 feet while Carl's will reach 790 feet.

Pretty interesting, don't you think? The more we use these charts here at Estes Industries the more new things we can find to do with them. By computing performance data for various size engines, different rocket weights, and different amounts of drag one soon gains a real understanding of these heretofore hard to grasp principles.

To encourage all rocketeers to order and start using TR-10, we're making it available at the reduced price of \$.20 to all who order before midnight, February 28, 1967. After that date, TR-10 will be available to all at it's regular price of \$.50 per copy.

For:

A Engine Charts See page 4.

Coasting Charts See page 5.

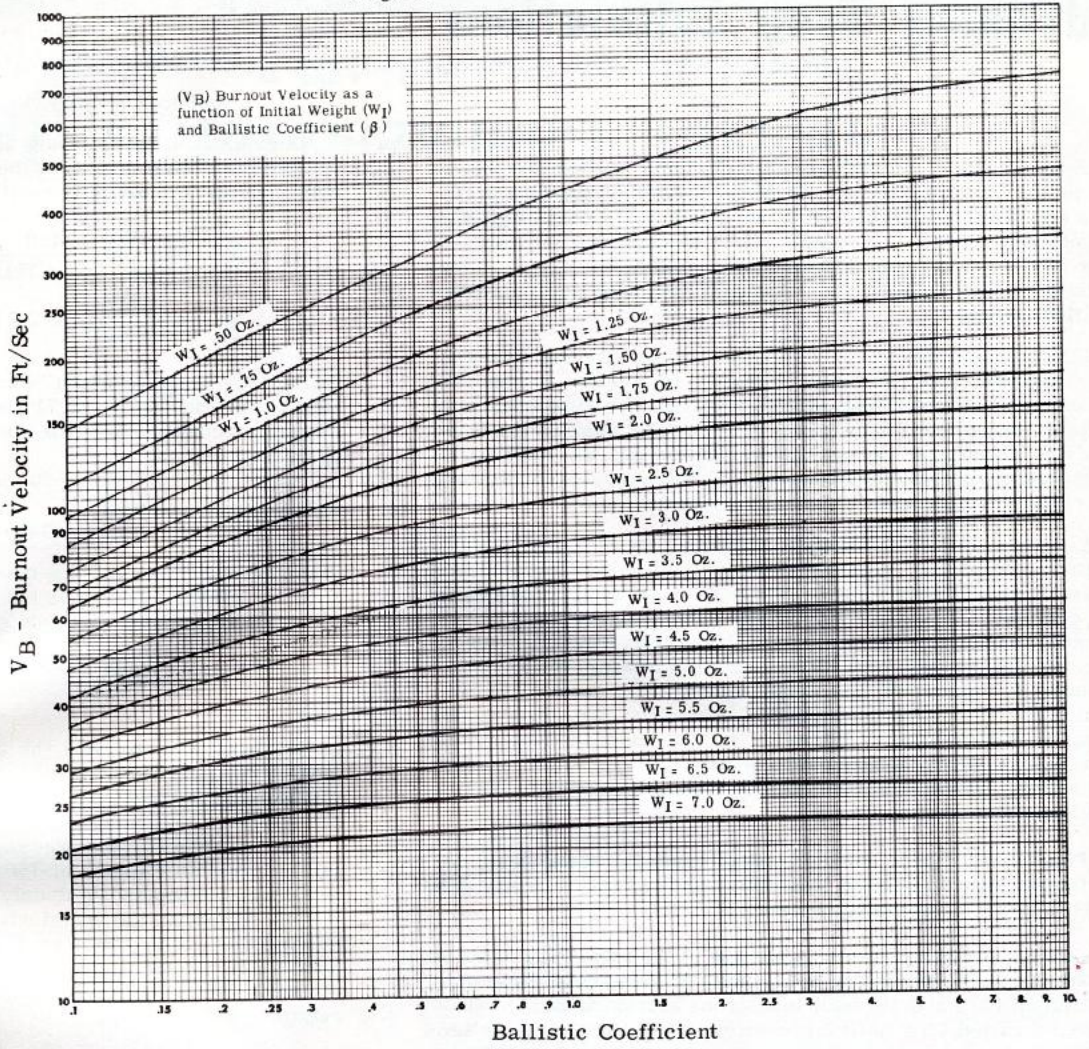

A MOTOR

Burn Time
 T_b = 0.90 Sec.

Propellant
 Weight
 W_P = 0.1350 Oz.

1/2W_P = 0.0675 Oz.

Average Thrust
 T = 0.1245 Oz.

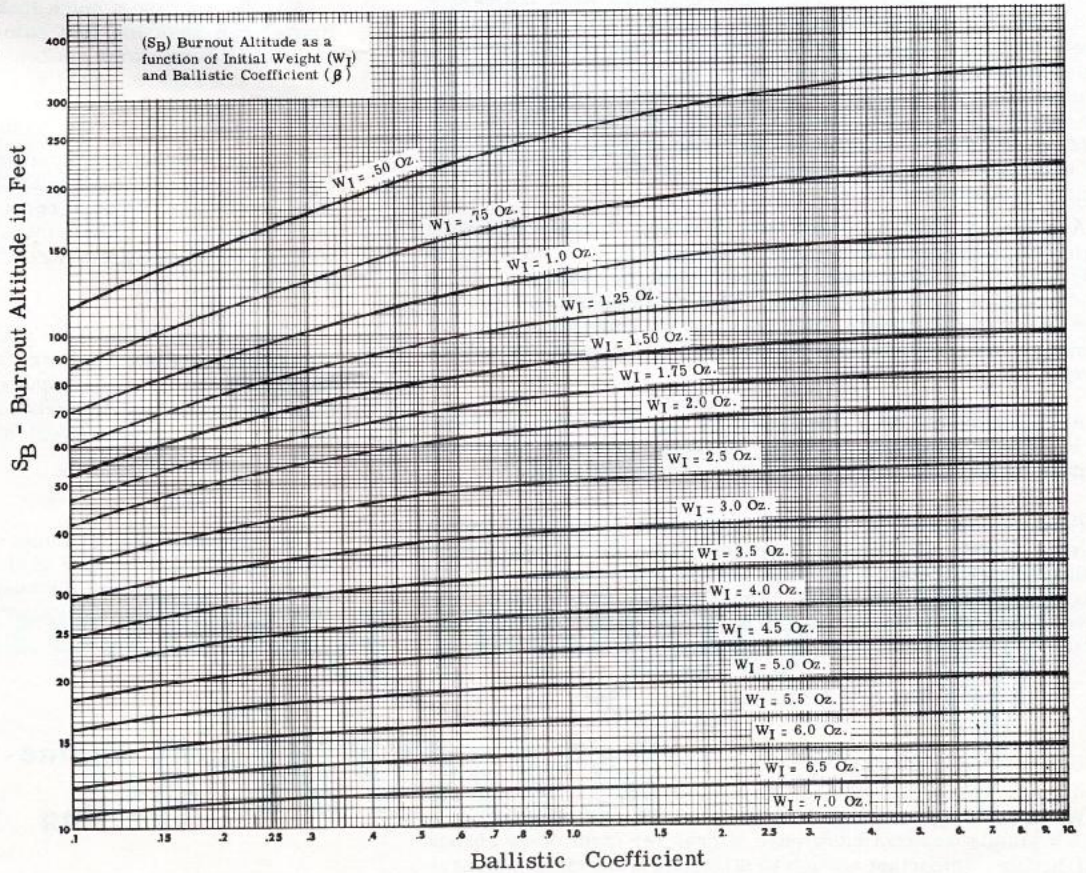

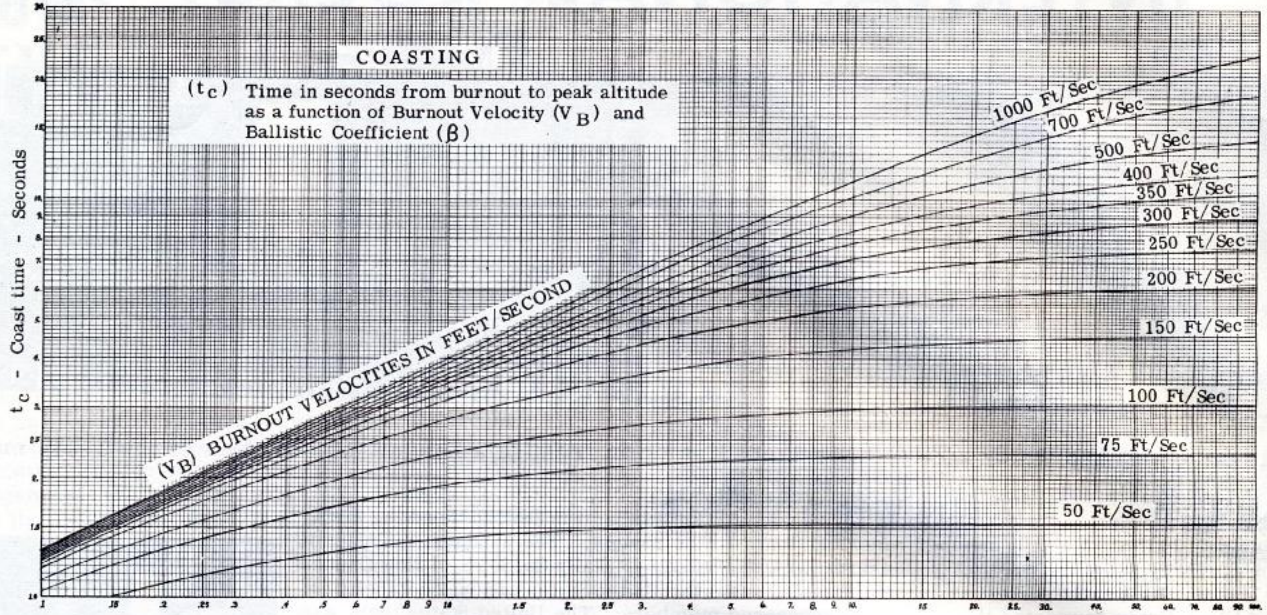

$$\beta = \text{Ballistic Coefficient} = \frac{W}{C_{DA}} = \frac{\text{ounces}}{\text{Inch}^2}$$

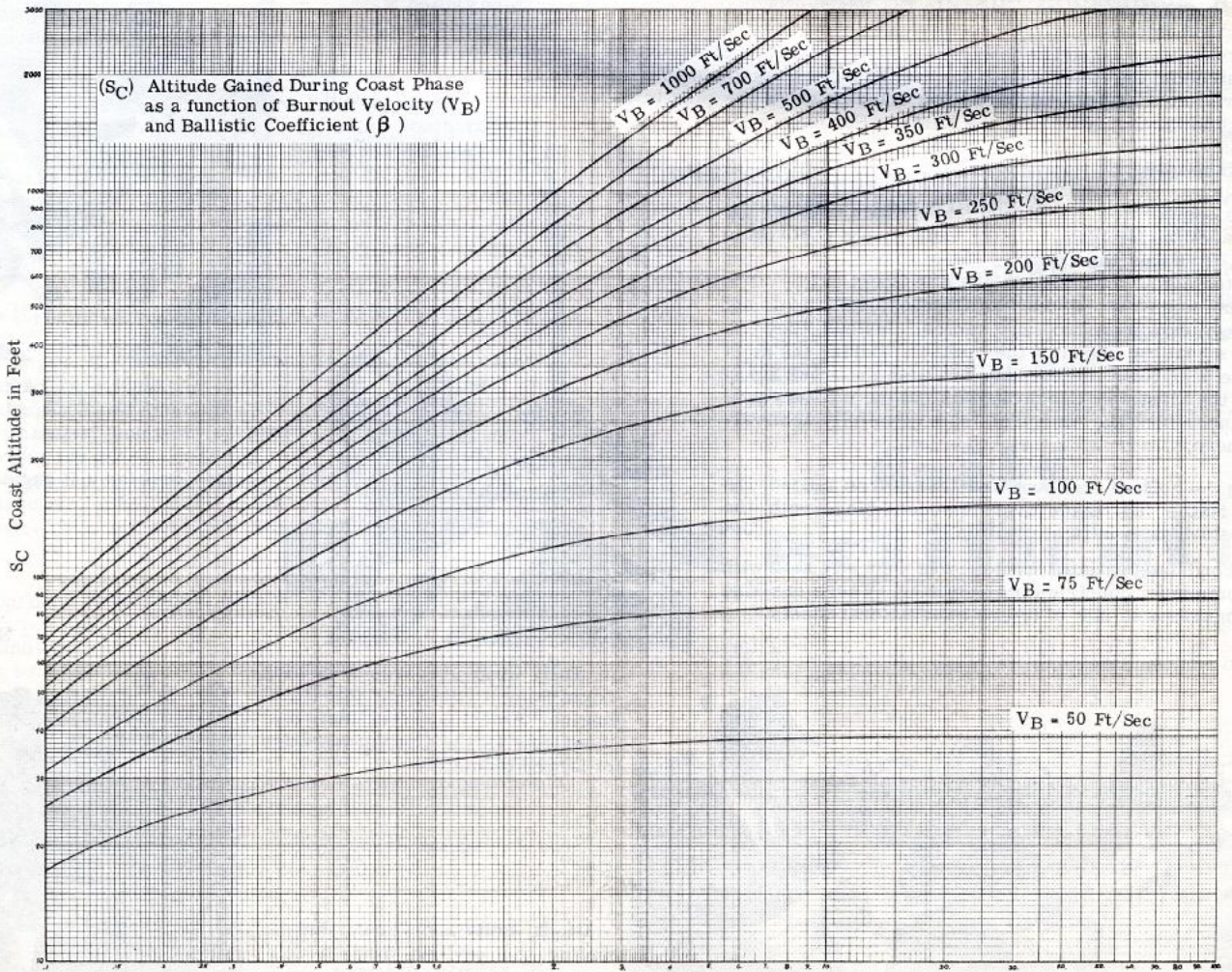

$$\beta = \text{Ballistic Coefficient} = \frac{W}{C_{DA}} = \frac{\text{ounces}}{\text{inch}^2}$$

1st INTERNATIONAL ROCKET MEET

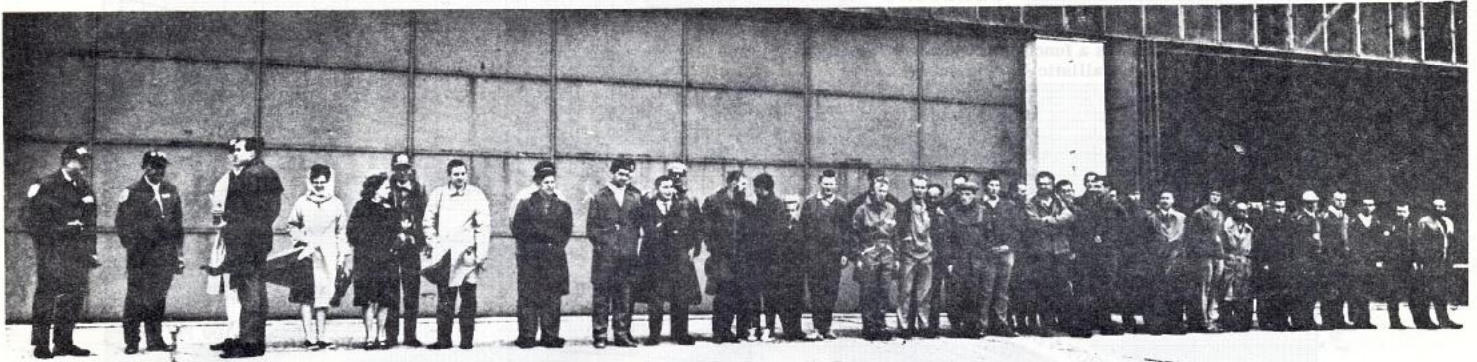

Its cold, wet and windy as the contestants line up in front of a hanger for the start of the 3-day meet.

In May of 1966 the first international model rocket competition was held in Czechoslovakia. Estes Industries sent half of the eight member American team to the contest. The youngest member of the team was Betty Estes, 14, who has grown up with model rocketry. Tally Guill, 16, of New Canaan Connecticut, was sent to the contest as Junior Champion from the United States national competition. Vern and Gleda Estes completed the four Estes sponsored members. The United States team was the only free world entry. Other participating countries were Poland, East Germany, Hungary, Yugoslavia, and Czechoslovakia. There were approximately 50 contestants present at Dubnica.

An airstrip, used for training Czech pilots, was the scene of the contest. Around the runways grew lush green meadows similar to the country in many parts of the Eastern United States. A great deal of interest in model rocketry was shown by the citizens around Dubnica and the American model rocketeers found Czechoslovakia to be a very friendly country. Everyone the team members met, welcomed the Americans. Contestants from all the countries were interested in the Estes model rocket supplies--of particular interest were the plastic parachutes, decals, the Electro-Launch and the Camroc. Only the Eastern European weather was not so friendly; it was cold and rainy during most of the meet.

In the competition, the United States team took the top four places in Payload, with T. Guill first, G.H. Stine second, G. Estes third and V. Estes fourth. The Estes family team also took second place in Boost Glide. The American team reports that the Czechoslovakians do not use range phones or two-way radios. Instead, they use flags to signal the launch of the rockets. During the meet the American team did not have to chase their own birds beyond the airstrip--Czech citizens and the military gave assistance which the American team gratefully acknowledges here.

When the contest was over and the scores tallied, the United States has taken overall second place with the Czechoslovakians in first position.

A second international contest was recently held with only Communist countries participating. There has also been considerable talk of future international meets.



Czechoslovakian ALFA compares in size with the Estes ALPHA kit. Their engines, larger in diameter but shorter than ours, provide the same power as a B engine.



Tally Guill prepares a winning flight using a Tilt-a-Pad and B 3-5 engine. Americans took their own launchers as the Czech rods were of larger diameter.

5 - 4 - 3 - 2 - 1 - START!



Gleda, Betty and Vernon Estes holding the payload birds which earned the family team a 2nd place trophy and Mrs. Estes an individual 3rd. Note the flag in the upper right corner - ready to signal a launch to the tracking station.



NOTES FROM THE BOSS

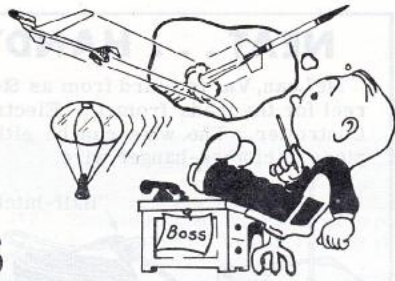

The fact that the Communist countries (DUBNICA, Page 6), were the main participants in the Dubnica meet points out some strange and important facts: Model rocketry got its start in the United States and our country is still first in the field. We do not know, however, how long this leadership position will exist. Apparently many of the communist governments recognize the values of model rocketry and promote it because of these values. We have seen several magazine articles showing participation in Red China and Russia. There is a rumor Russia now has at least 5,000 model rocket clubs. Obviously, this type of activity in a "state controlled" country requires full government support and encouragement. With the positive* safety values of model rocketry and its tremendous educational potential, we sometimes wonder why some elements in our own government wish to suppress our modeling activities.

Could the underlying causes stem from the past? We believe they do. When our law making and enforcement officials were young, most of them had a different opinion of rockets from the youth of today. If they talked of rockets, they thought of the fourth of July, fireworks and explosive devices ignited with a match and a fuse. They didn't think as we do, of rockets as vehicles for travel or a means of exploring the unknown. Then too, they grew up and lived through the years of 1954 to 1962--the bloody years before model rocketry could replace the "Basement Bomber's" activities--the years in which youth rocketry was extremely dangerous because everyone was getting the bug to build a rocket, but there were no safe materials to which to turn. The memories of the headlines of these years or personal investigation of a serious accident undoubtedly made many of them fear all youth rocket activities.

Perhaps then, we as modelers should be sympathetic towards persons who do not understand our model rocket interests and activities. It is a well known fact that we all base our judgement and decisions upon past experiences. These decision-influencing experiences come from all of our activities; from the day we are born until the present time. If, in the past, a person saw something bad in rockets or saw someone seriously injured or even considered them as playthings rather than a safe, constructive hobby, then they will no doubt base their opinions of model rocketry on these past, "somewhat related," experiences.

If we approach these people with the idea that they are "dumb clucks" for not understanding our view points, we will only insult them and deepen their prejudice. If, on the other hand, we are willing to listen to their reasons for not liking rockets first, and then explain how our rockets are different, perhaps we can thus provide them with new experiences which will let them change their view point to favor model rocketry. We hope so, because, otherwise, model rocketry cannot be fully accepted until all of today's model rocketeers have grown up and taken their positions as law making and enforcement officials.

VERN ESTES

* Positive Safety Values. The word "positive" is used here to indicate that our country and its youth who fly rockets are safer because model rockets are a part of our society. Even though there is some danger with model rocketry, there is ample evidence to show there are vastly fewer accidents in youth rocketry when model rockets are readily available.

New Products

HONEST JOHN

Recommended Engines
B. 8-4, A. 8-3
1/2A. 8-2



High performance flying scale model of the U.S. Army surface-to-surface missile. The Honest John features parachute recovery, exact detailing, a complete set of decals and many other items to make this one of the most exciting models you'll ever build. Recommended for experienced modelers, this kit comes complete (but no engines). See this issue's wrapper for specifications. Shipping weight 14 ounces.

Cat. No. 651-K-27

Only \$2.00 each

Christmas 1966

What better gift for the rocketeer than rockets? Not sure which rocket to get him? In that case, an Estes gift certificate is perfect. Not only is it the convenient way of giving, but it comes as a surprise and yet lets the recipient choose his own gift.

To get a gift certificate, just fill out the form below (or a reasonable facsimile) and mail it with your check or money order for the desired amount to Estes Industries. Your completed gift certificate will be returned via Air Mail. (Gift certificates are great for birthdays and other occasions around the year as well as for Christmas giving.)

Gift Certificate

Order Form

Gentlemen:

Please prepare a Gift Certificate as shown below:

Amount: _____ \$

From: _____

To: _____

MAIL CERTIFICATE TO:

Name: _____

Address: _____

City: _____ State: _____ Zip: _____

| | | |
|------|-----------|-----------|
| DATE | CERT. NO. | ISSUED BY |
|------|-----------|-----------|

The Idea Box

Compact Paint Drying Aid

A neat fingerprint-proof way of drying that freshly painted nose cone or adapter is suggested by Zachary Zapack of Fort Lauderdale, Fla. A jar and an extra brush or dowel is all the "extras" you will need.

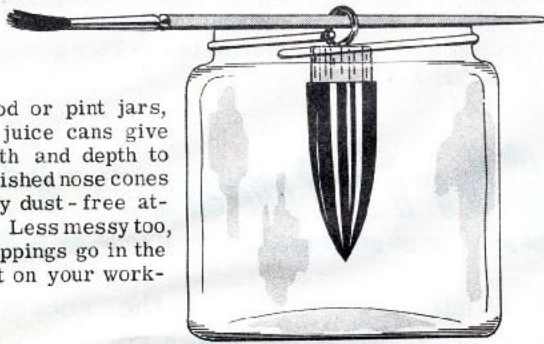

Baby-food or pint jars, or frozen juice cans give ample width and depth to dry dip-finished nose cones in a nearly dust-free atmosphere. Less messy too, for the drippings go in the jar and not on your work-bench.

TIP: Check your shock cords periodically. Even the quality pure rubber used in Estes kits can deteriorate from age and chemical erosion. Watch for frayed edges and small cracks developing in the rubber surfaces.

GROOVY !!

Darrel Quick of Elkview, W. Va. makes preparation of multi-stage engine units easy by placing them in the "pencil groove" of a regular 12" school ruler for applying the tape.

Direction of rotation as tape is applied

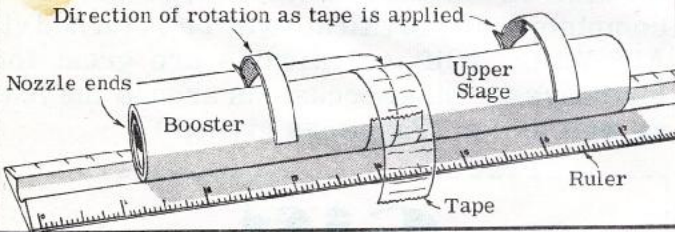

Fins Damaged at Landing?

Set fin far enough from the rear of body tube to allow space for dowel.

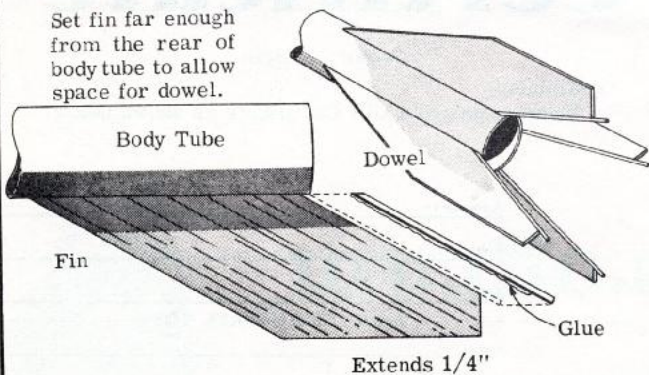

Fin damage may be minimized by gluing a piece of dowel to the inside trailing edge of the fin as shown. This idea is sent in by Lamon Henderson of Gadsden, Ala. who has an unusually rocky launch and landing area to cope with.

NEAT . . . HANDY TOO

McLean, Va. is heard from as Steffen Parcels suggests a reel for the leads from the Electro-Launch to the Launch Controller. The wire can be either 1/8" welding rod or a piece of clothes-hanger wire.

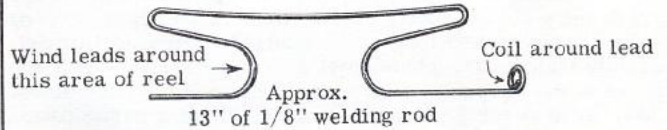

"Little Boxes . . ." find use in Model Rocketry too!

Labels on PRM may be placed on tops or in the front of each bin

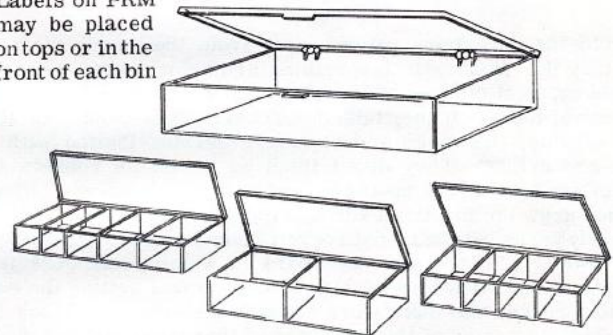

Kenneth Parchinski of Brooklyn, N. Y. suggested an addition to your range kit to keep things sorted out. Partitioned plastic boxes come in a variety of sizes and partition spacing and can be found in most any hardware store.

Launching Lug Alignment

Robert J. Jeary of Greenfield Park, Quebec sends an easy way to be sure of correct launching lug alignment. No tools, drawers or sills are necessary--just one good eyeball!

Apply glue to lug and put into place. While still wet, align.

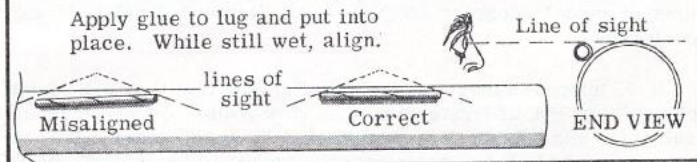

A note of thanks to all you model rocketeers who keep the idea suggestions flowing. Were you on the receiving end, you'd certainly realize what an impossible task it is to answer each suggestion author personally.

It is amazing how much you fellows think alike across the country. This may account to each of you, however, why your suggestion may not have been chosen for the idea box. If we see an idea repeated from coast to coast, it is considered generally known. It's the single ideas (sometimes so simple you wonder why nobody thought of 'em before) that will be a real help to all model rocketeers across the country that are chosen for print.

Don't let this discourage you--your very next idea may be just the one we're searching for!

Odd BALL

Contest Winners

This contest brought in many entries of interest from all parts of the country. Many hours of careful scrutiny resulted in the final choice of the winners. Some of the entries were chosen for one feature which in our opinion may be a lasting contribution to the field of model rocketry.

Presented here are drawings and instructions for the first four place winners, and a list of the other six entries comprising the top ten spots.

1st "Bat"

The BAT is a glider of para-wing design by David Swoboda of Minasha, Wisconsin. His plans included a 3-engine cluster booster using a BT-60 body tube 18" long. However, a Ranger or a Cobra (or a Bertha) will launch this glider. Here are the instructions for building your BAT.

The pattern group must be enlarged from the present half-size. By using dividers, you may wish to lay out the enlargements directly on the wood. If you draw the enlargements, draw them on stiff paper, and include grain direction and all dotted lines, as well as the part number. Lay out the parts on the wood, cut out and sand them smooth before assembly. Place the half-wing pattern's centerline to the folded edge of the PM-2. Cut carefully around the perimeter and notches of the pattern. Unfold the PM-2 and you have a delta-shaped wing with 1/8" x 1/2" notches down it's centerline.

Lay the horizontal center rib on a flat surface (with the dotted lines facing you). Lay the wing material on this piece so the center of all notches line up with the centerline of the horizontal center rib. Hold the plastic in place and apply glue along all exposed parts of the horizontal center rib along the centerline. Apply a thin line of glue to the top edge of the vertical center rib. Place the vertical center rib rear edge even with the rear edge of the plastic material and over the centerline pressing down firmly to make good contact with the parts of the horizontal center rib thru all the notches and at the front end. Hold this part in place until the glue has set.

Glue one outer wing rib to part #WH-1 as shown. Repeat this step with the other outer rib and WH-1. Cut two 3/16" x 6-5/8" strips of PRM-1. Lay one strip along the leading edge of one side of the wing material. Repeat this step with the other strip and the other leading edge of the material.

Apply glue to the centerline of the NP-1 nose piece and put it in place on the bottom front of the vertical center rib. Follow this with part #NP-2, one on either side in the locations shown. The parts #NP-3 are finally placed at the rear outside edge of each piece of NP-2.

Dave specified a piece of TH-1 for hinging the outer rib-wing holder assembly to the vertical center rib. We found a piece of plain cottoncloth cut 1/2" x 1" made a more durable hinge. Glue the cloth hinge in place with white glue by first gluing it to the front of the WH-1, then fitting the WH-1 into place (in extended position) and gluing the remaining hinge material to the vertical center rib.

Apply a line of glue to the inside bottom edge of one outer rib. Carefully align the inside edge of the PRM strip with the inside edge of the outer rib as viewed from the top and press into the

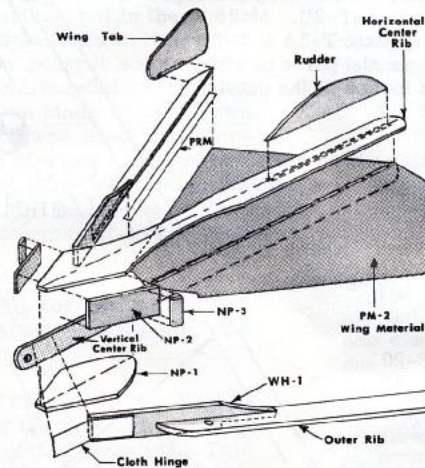

PARTS LIST

- | | |
|---------------------------|--------|
| 1 Sheet balsa stock | BFS-40 |
| 1 Sheet balsa stock | BFS-20 |
| 1 Sq. ft. 'chute material | PM-2 |
| 1 Sheet paper reinforcing | PRM-1 |

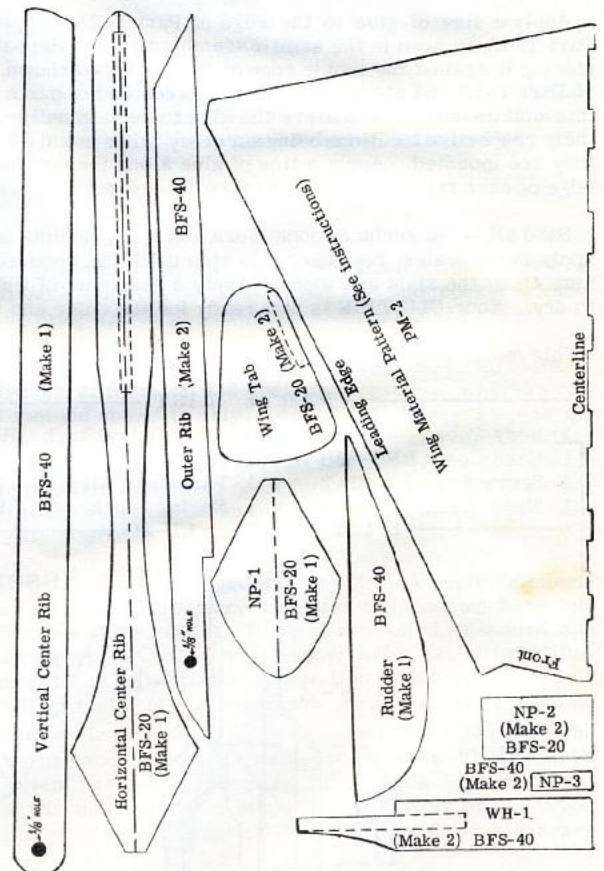

glue spread along the bottom of the outer rib. Repeat this step with the other wing panel and outer rib.

Apply glue to the root edge of the rudder and place it into position on top of the horizontal center rib. Apply glue to the proper section of a wing tab and place it on the tapered end of an outer rib. Repeat this step with the remaining wing tab. Be sure the tabs and rudder dry in a vertical position.

Drill a 1/8" hole thru the vertical center rib as shown and thru each of the outer ribs at the points marked. Tie a knot in one end of a shock cord and thread the cord thru one outer rib, then, thru the vertical center rib and finally thru the other outer rib. Test the tension and pull tight enough to give positive but not violent action to each wing section as it goes into place. Hold the shock cord in place with a finger on the top side of the outer rib while you tie a knot in the cord snug against the underside of that rib. Clip off the excess shock cord and apply a drop of glue on each hole of the outer ribs only. When the glue has dried test the wing action again. Note the shock cord will equalize the tension on both sides by being able to move freely thru the hole in the vertical center rib.

After all parts have dried thoroughly, brush on a coat of sanding sealer on the wood surfaces only. Lightly sand the model and brush on a color coat of your choice.

2nd

STILTFIN

The STILTFIN - designed by Jeffrie Selby of Greenfield Park, Quebec, Canada is the second place winner. Consider the many applications of this fin arrangement, either in its present form or modified to a more esthetic shape. Here is a method to easily convert that short bird (you've been meaning to replace those damaged fins anyway) to one of unusual appearance.

If you "scratch-build" this one, build the body tube portion as shown in standard chute recovered model rocket style. Mark the body tube for two fins and set the launching lug position half way between them on one side of the body tube as shown.

Trace all patterns onto stiff paper. Lay out the parts on the proper size balsa fin stock and cut them out. Lightly sand all parts before starting assembly. Glue the fins (F-1 & F-2) to the body tube. Glue the tail booms to the outer edges of the fins as seen in the side view. Glue a boom gusset on each side of the fin-boom joint as seen in the semi-assembled view. Set the assembly aside to dry while the tail fin unit is being put together.

Apply a line of glue to the edge of Part T-2A and place against the inside edge of Part T-1A as seen in the semi-assembled view. Repeat this step with Part T-2B, placing it against the inside edge of Part T-1A as shown. Apply glue along the edges of Part T-1B and place it against the other end of parts T-2A & T-2B. Make sure this unit is square and allow the glue to set. Finally, glue Part T-3A & T-3B in their respective locations being sure they stick out at 90° from the parts to which they are mounted. Apply a line of glue along the bottom 2 inches of the outside edge of each tail boom and locate the fin unit as shown.

Sand all balsa surfaces once more and apply sanding sealer. Sand again and apply more sealer, repeating this step until the wood surfaces have become smooth to the sight and touch. Apply a base coat of white enamel and allow to dry. Your STILTFIN is now ready for the color and trim of your choice.

This model may be flown with any Series I single or upper-stage engine.

PARTS LIST

| | | | |
|-----------------|---------|---------------------|--------|
| 1 Body Tube | BT-20 | 1 Sheet Balsa Stock | BFS-20 |
| 1 Nose Cone | BNC-20B | 1 Sheet Balsa Stock | BFS-30 |
| 1 Screw Eye | SE-2 | 1 Parachute Kit | PK-12 |
| 1 Shock Cord | SC-1 | 1 Engine Block | EB-20B |
| 1 Launching Lug | | LL-2B | |

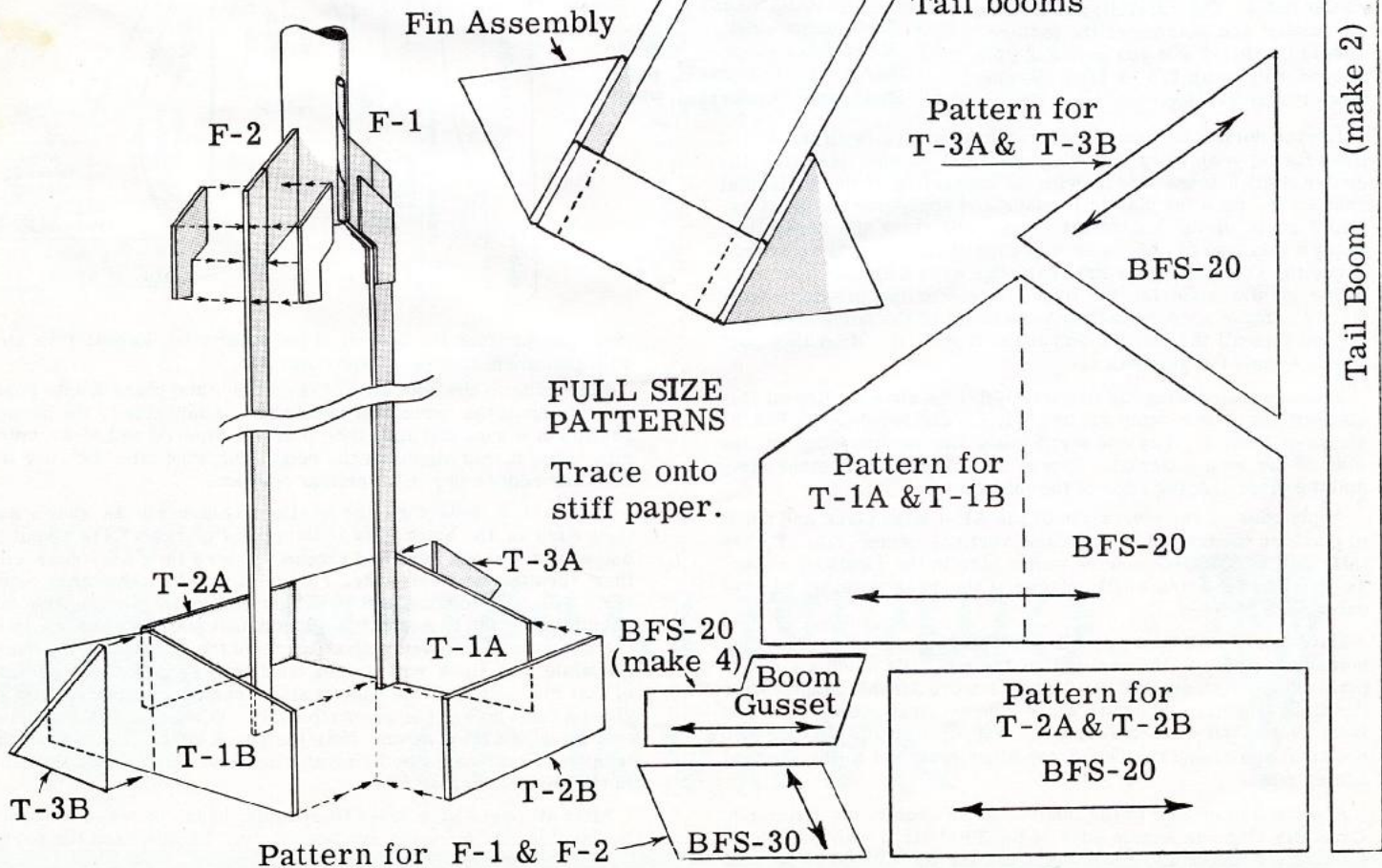
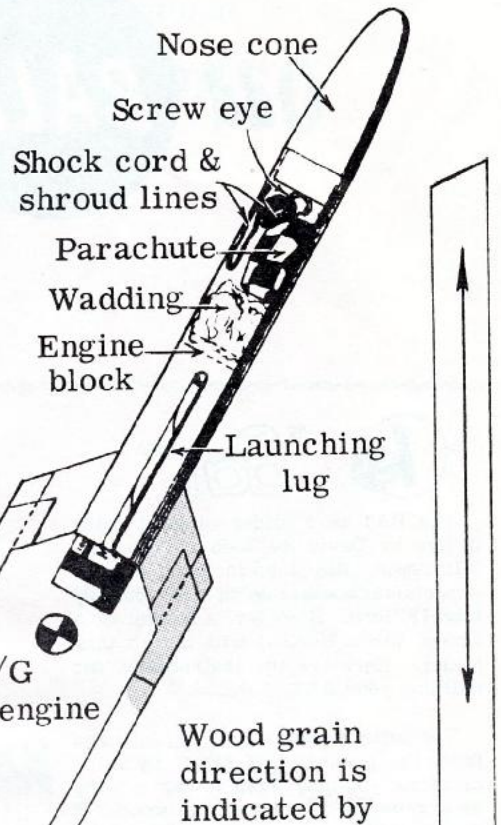

THE FLYING WHY

Modified from the original plans of JOHN P. CHILDS
Rockaway Beach, New York.

PARTS LIST

| | | |
|---|-------------------|---------|
| 1 | Nose cone | BNC-30N |
| 4 | Nose cones | BNC-30D |
| 4 | Body tubes | BT-30 |
| 3 | Sheet Balsa Stock | BFS-20 |
| 1 | Engine holder | EH-2 |
| 1 | Launching lug | LL-2B |
| 1 | Parachute, 12" | PK-12 |
| 1 | Shock cord | SC-1 |
| 1 | Screw eye | SE-1 |

Straightforward model rocket construction applies to assembly of the recovery, payload and main body and fin portions of this bird. Special attention must be paid to tapering ends of the angle support tubes for a neat fit. Be sure to cut the ports or your recovery system will not function. Double glue all of the tapered body tube joints.

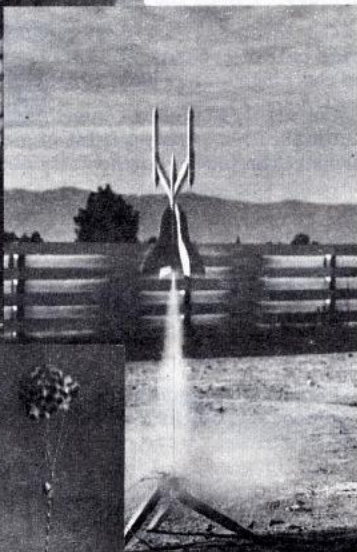
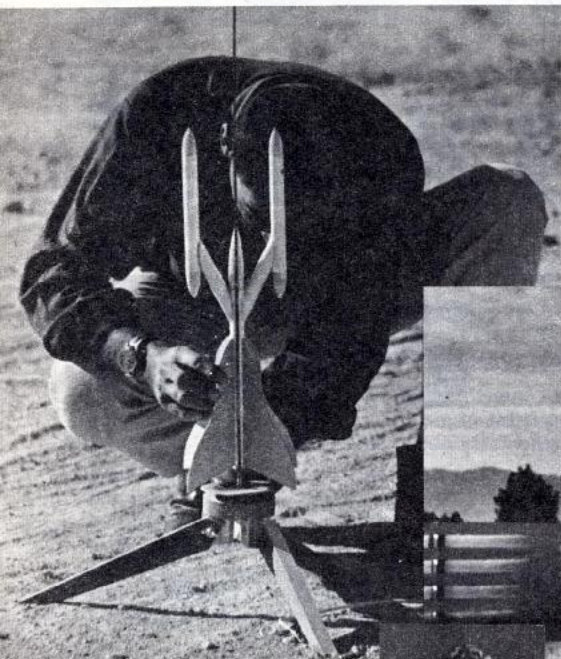

Shaded arrows show the path of ejection gases through ports and into the recovery section base.

Sand all edges except root edge round. Sand both sides of all fins to a smooth surface.

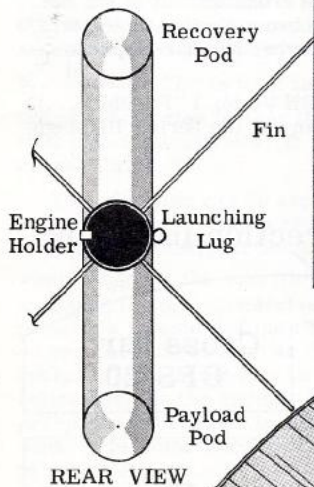

Showing relative alignment of all components.

Engine Holder (EH-2) secures the engine throughout the flight yet allows easy engine changing. Secure in place with glue and gauze leaving the rear 1" free to move.

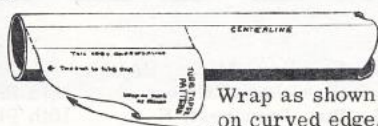

Recovery assembly--parachute, shroud-lines, shock cord and anchor plus screw eye.

Wadding

Recovery section

Nose cones (BNC-30D) top off the recovery and payload sections.

Nose cone (BNC-30N) cement securely in place.

BT-30 4-1/2" (make 2)

Payload section
BT-30 6" long (make 2)

Nose cones (BNC-30D) used here as tail cones. Cement securely.

HALF-SIZE FIN PATTERN

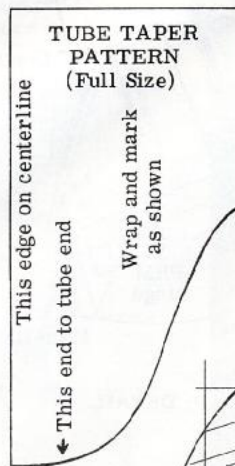

2-piece fins (of BFS-20) Four are required. Cement and fillet securely.

Grid point lines are provided for easily enlarging the pattern

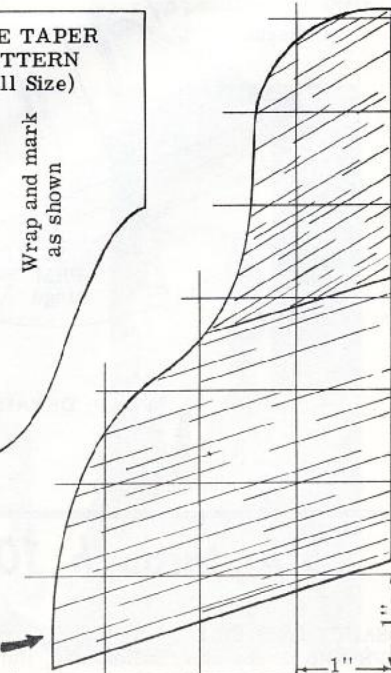

4TH FLIP FLAP

Design by Dennis Kurovsky
Medford, Oregon

Here you see one of the few designs built around a Series III engine, and one having an "airbrake" type of recovery system.

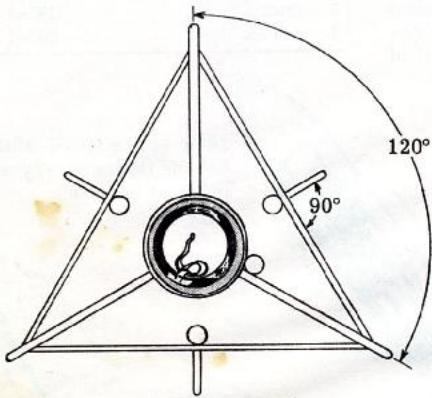

REAR VIEW

Shown with nose cone, control lines and elastic thread omitted. Engine block and shock cord with anchor as seen inside tube from this view.

Shown here with flaps in upward flight mode - flap-control lines thru the protectors and ready to be secured in this position by inserting the nose cone.

Engine block is placed 1-9/16" from the rear of the body tube.

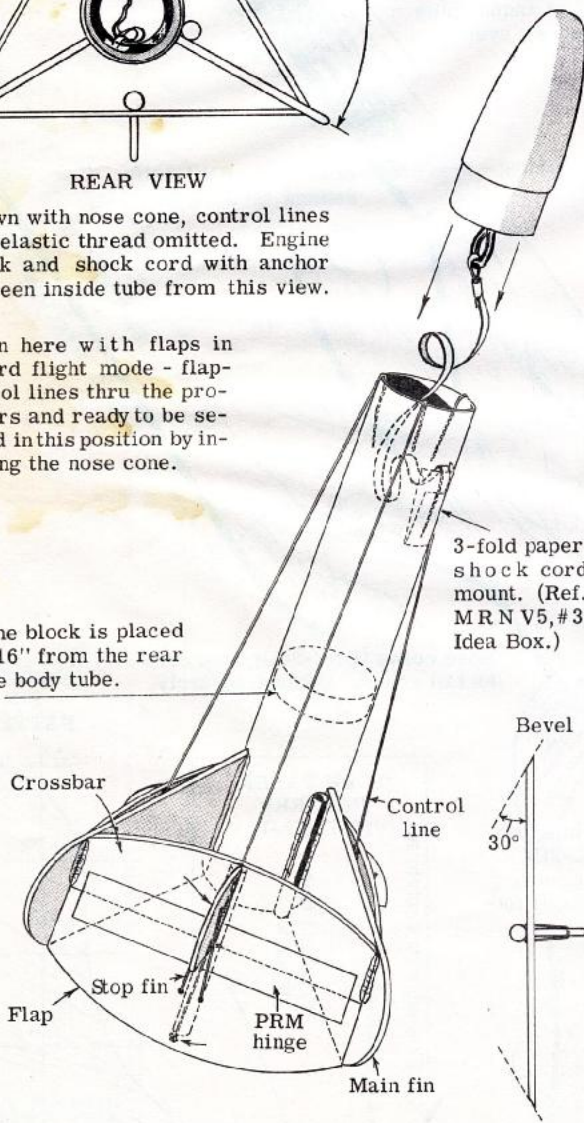

3-fold paper shock cord mount. (Ref. MRN V5, #3 Idea Box.)

Bevel

30°

FLAP DETAIL

Glue the engine block in place. Mark the body tube for 3 fins. Assemble the shock cord mount and install it in the front end of the body tube, leaving enough room at the front for the nose cone to seat properly. Set this assembly aside to dry.

Trace all the patterns onto stiff paper; cut them out, and use as templates to lay out 3 of each part on the proper thickness of balsa fin stock. Cut out all the parts. Round all edges except root edges, hinge edges and the ends of crossbars and flaps. Sand the sides of all parts smooth. Lightly draw in all dots and positioning lines as shown on the patterns.

Glue the main fins to their locations around the rear of the body tube. (See rear view.) Sand the tube on its nose until the main fins are dry. Install the screw eye into the nose cone in the usual way.

Cut three 3/4" x 2-3/4" pieces of PRM-1. Apply one piece to each pair of crossbars and flaps as shown. Glue stop fins in place on the hinge side of each crossbar. Set the assemblies aside to dry.

Cut a 1-1/4" piece of launching lug and glue it beside any one of the main fins. Apply a fillet of glue around each tube-fin joint and support the model horizontally until the glue has dried.

Bevel the ends of the bar-flap assemblies to fit against the main fins as shown in the fin detail. Thread the elastic thread thru the dot on the stop fin and thread each end thru one dot on the flap as shown. Fold the flap against the stop fin, draw both lengths of thread thru the flap until tension of the thread holds the flap against the stop fin. Force a drop of glue into each thread hole and when set, trim off the excess thread. Repeat this step with the other two bar-flap assemblies.

Cut three 1" and three 1/2" pieces of launching lug. Glue the 1" pieces to positions on the flaps, and the 1/2" pieces in line with the first ones, on the crossbars. Cut three pieces of shroud line 6-1/2" long. Thread one line through both sections of "line protector" from the top and thread the end through the flap as shown or glue the last 1/4" of the line to the bottom edge of the flap. Repeat this with the other two lines and bar-flap assemblies.

Apply glue to the beveled edges of the crossbar only of one bar-flap assembly and put in place between two main fins on the location marks. Repeat this step with the other two bar-flap assemblies.

Give the rocket a fine finish (ref. MRN V6, No. 1 "Finishing..."), and FLIP FLAP is ready to fly. Use any of the Series III single stage engines.

Make 3 of each part.

PATTERN GROUP

Grain direction indicator

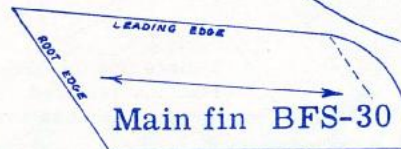
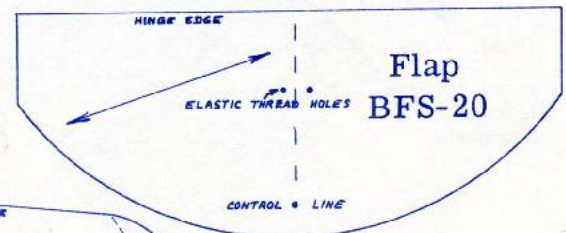
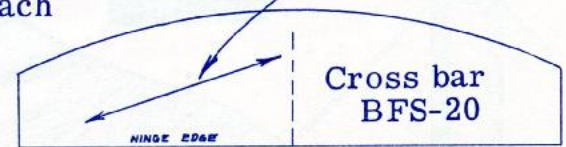

5th through 10th Place Winners

SAUCY SAUCER I by Stan Thorp, Denver, Colo. 5th Place.
PROBE 12 by Morris Edelman, Huntington Woods, Mich. 6th.
BOX KITE by Roger Garrett, Sussex, New Jersey. 7th Place.

GYROSTABLE by Paulo R. Krohling, Minas, Brasil. 8th Place.
THE SPEAR by Lamar Stoller, Latty, Ohio. 9th Place.
EXOS by Gaetano Lo Bue, Demarest, N. J. 10th Place.