



Intruder™ ASSEMBLY INSTRUCTIONS

Things You'll Need To Assemble this Kit:

Hobby Knife, Pencil and Paint Brush

Sandpaper (220 or 320 Grit) & Sanding Sealer

White Glue

Aliphatic Resin glues work best such as TITEBOND or ELMER'S CARPENTER'S WOOD GLUE - ELMER'S WHITE SCHOOL GLUE also works but dries slower.

Plastic Cement

Use TESTORS TUBE Plastic Cement, PACTRA LIQUID CEMENT or other comparable brands.

Tape & Paint

Scotch Magic Tape or Paper Masking Tape and Spray Paint

Scissors, Tweezers and Wax Paper



Product No. 3001

Skill Level Three



BEFORE STARTING ASSEMBLY READ THROUGH THESE INSTRUCTIONS. IT IS BEST TO TEST FIT ALL PARTS BEFORE APPLYING ANY GLUE. READ AND FOLLOW THE NAR MODEL ROCKET SAFETY CODE.

PARTS LIST

- A. 49000 Motor Clip
- B. 14000 Blue Thrust Ring
- C. 10303 Yellow Motor Mount Tube
- D. 14050 Red Centering Ring (2)
- E. 33004 Die-Cut Balsa Fin Set
- F. 11306 White Body Tube
- G. 20100 Plastic Nose Cone
- H. 20101 Nose Cone Base
- I. 10001 Launch Lug
- J. 50011 18 inch White Elastic Shock Cord
- K. 50051 18 inch Yellow Kevlar* Shock Cord
- L. 28102 12 inch Parachute
- M. 50100 Pack of 3-26 inch Shroud Lines
- N. 28001 Strip of 6 Gripper Tabs
- O. 91006 Self-Adhesive Decal
- P. 90056 Instruction Sheet
- Q. 90156 Launch Procedures Sheet

* Kevlar is a registered trademark of Dupont

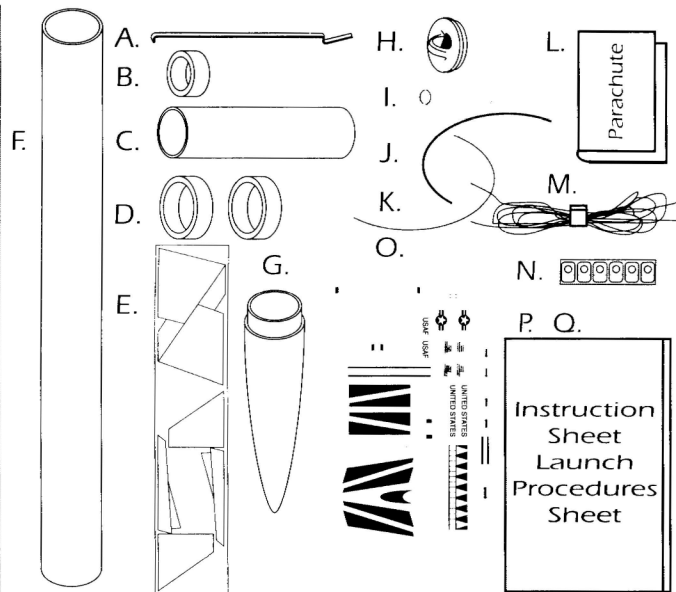

STEP 1

A. Apply plastic model cement (not white glue) around the inside edge of the plastic nose cone. Push the base into the nose cone. Set aside to dry.

Plastic Model Cement

B. Place the Blue Thrust Ring up against the side of the Yellow Motor Mount Tube and use it as a guide to make a small 1/8 inch long slit in the side of the Yellow Motor Mount Tube as shown.

Yellow Motor Mount Tube

Make 1/8" Slit with Knife

C. Make a slight bend in the Motor Clip as shown. Insert the Motor Clip into the slit you made in the Yellow Motor Mount Tube.

Blue Thrust Ring

Bend Slightly

Yellow Tube

1/8" Slit

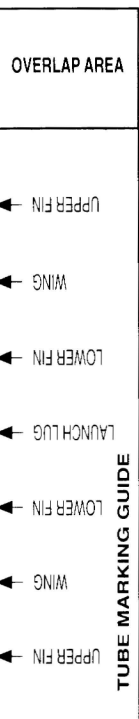
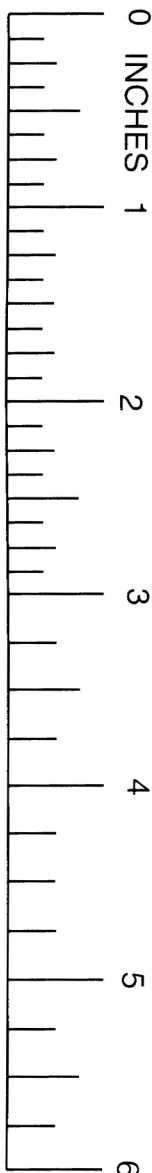

Instruction Sheet
Launch Procedures Sheet

STEP 2

A. Test fit one of the Red Centering Rings onto the Yellow Motor Mount Tube. If it does not slide on easily, stretch the Red Ring by sliding it over the Nose Cone and gently twisting it back and forth a few times. Slide the Red Ring onto the Yellow Tube just far enough to hold the Motor Clip in place.

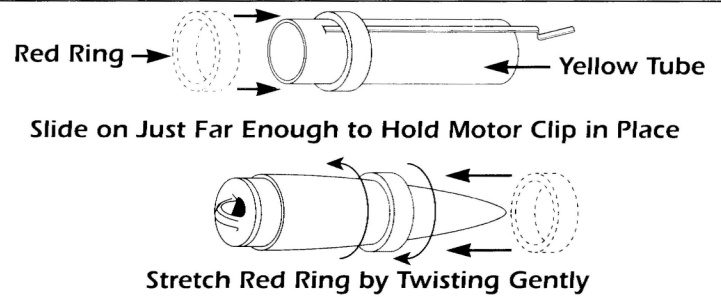

STEP 3

A. Apply a bead of white glue around the Yellow Motor Mount Tube 1/2 inch from the end as shown.

B. Slide the Red Ring into the bead of glue. Wipe away any excess glue.

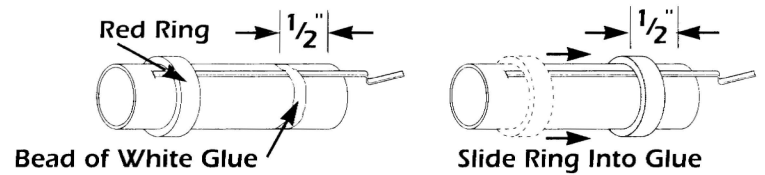

STEP 4

A. Tie two overhand knots 1 inch in from the end of the Kevlar Cord.

B. Pass the end of the Kevlar with the knot through the remaining Red Centering Ring.

C. Slide the Red Centering Ring with the Kevlar under it onto the Yellow Motor Mount Tube.

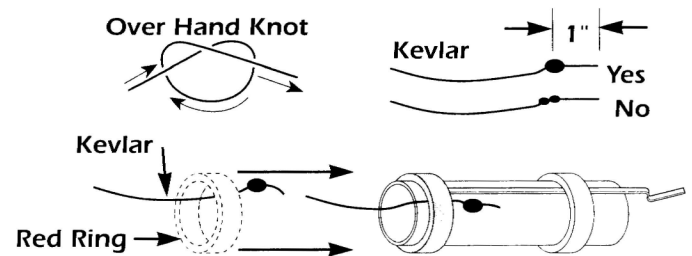

STEP 5

A. Apply a bead of white glue around the Yellow Motor Mount Tube 1/2 inch from the end as shown.

B. Slide the Red Ring into the bead of glue. Wipe away any excess glue.

C. Pull the Yellow Kevlar Shock Cord up tight against the Red Centering Ring.

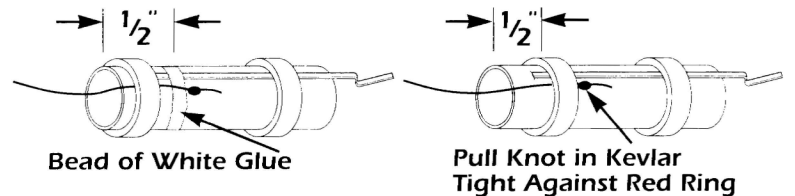

STEP 6

A. Apply white glue around inside edge of Yellow Motor Mount Tube as shown,

B. Insert the Blue Thrust Ring into the Yellow Motor Mount Tube so it is even with the end of the Yellow Motor Mount Tube.

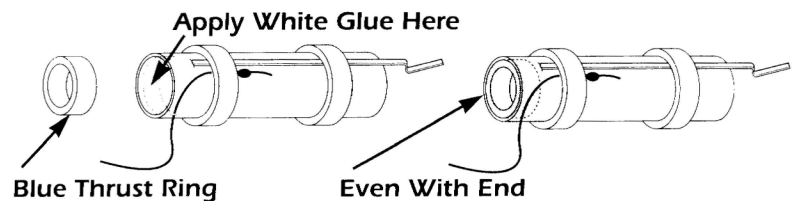

STEP 7

A. Hold the Yellow Kevlar Shock Cord and the White Elastic Shock Cord side by side. Pull one end of each cord so that they are even with each other. While holding the two cords together, tie a single parallel overhand knot approximately one inch in from the even ends as shown.

B. Gently pull on both cords to set the knot and prevent it from slipping.

C. Apply a small amount of white glue on the ends of both cords to prevent them from fraying.

NOTE: THIS IS A VERY IMPORTANT STEP. IF YOU TIE A DIFFERENT TYPE OF KNOT THE SHOCK CORDS MAY SEPARATE DURING FLIGHT.

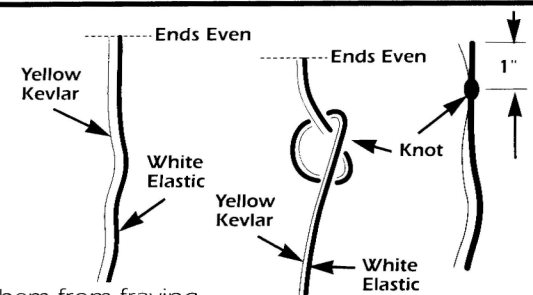

STEP 8

- A. Stretch one end of the Body Tube slightly by inserting the nose cone into the tube and gently twisting it back and forth a few times.
- B. Hold the Body Tube with the stretched end facing up and "feed" the shock cord into the tube until the cord comes out the other end.
- C. Grab the end of the shock cord and pull it all the way through the tube until the Motor Mount assembly that is attached to the other end pulls up against the tube.

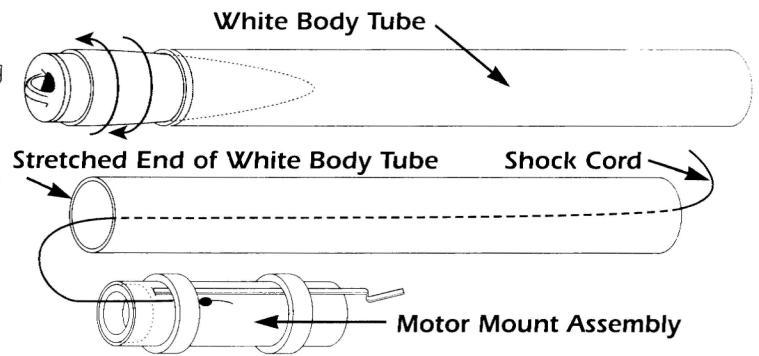

STEP 9

- A. Hold the Motor Mount Assembly and the Body Tube in one hand.
- B. Apply White Glue around the inside of the Body Tube.
- C. Immediately insert the Motor Mount Assembly and PUSH IT INTO THE BODY TUBE WITH ONE FAST & SMOOTH MOTION until the Yellow Motor Mount Tube is even with the end of the Body Tube

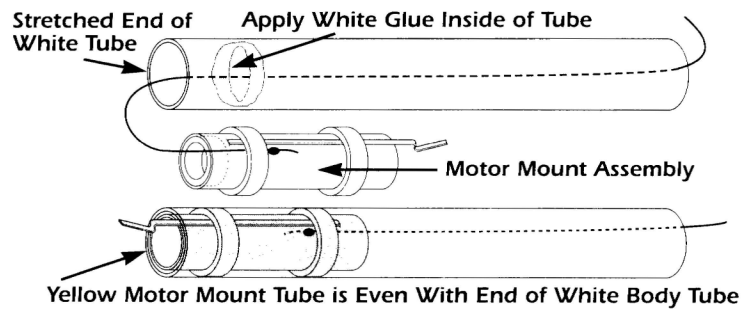

STEP 10

- A. Cut out the tube marking guide from the front page of the instruction sheet
- B. Wrap the tube marking guide around the body tube. Align the arrow that is marked "Launch Lug" with the motor clip. Mark the body tube at each of the arrows with a pencil.
- C. Use a door frame as a guide and extend each of the pencil marks 6 inches up from the rear of the body tube.

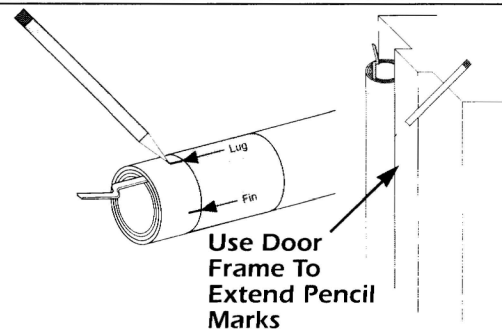

STEP 11

- A. Carefully remove all the die-cut balsa parts from the sheet with a sharp hobby knife.
- B. Stack alike parts together and sand all edges smooth and square.

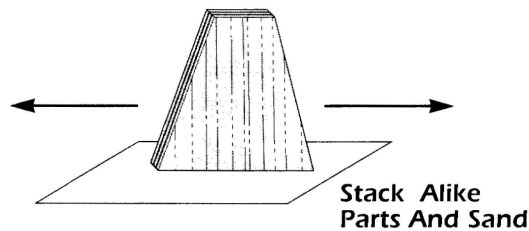

STEP 12

- A. Use white glue to assemble the wings and tail fins over a piece of wax paper on a flat surface.
- B. Apply glue to the connecting edge of the smaller piece and push parts together over a piece of wax paper.
- C. Check the alignment of the root edge of the pieces by lining them up with the edge of a ruler. Allow glue to dry before handling the parts further.

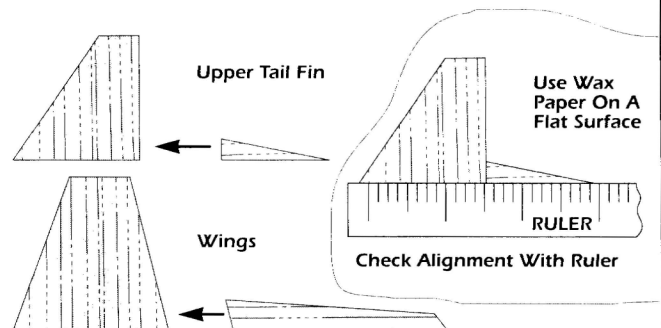

STEP 13

A. Apply white glue to the root edge of an upper tail fin. Position it on the alignment line .75" inch from the end of the body tube. Check to be sure it is projecting out from body tube as shown. Let dry for a few minutes. Repeat procedure for the other upper tail fin.

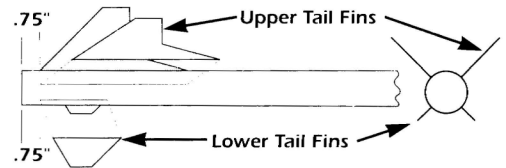

B. Apply white glue to the root edge of one of the lower tail fins and position on the alignment line .75" inch from the end of the body tube. Check to be sure it is projecting out from body tube as shown. Allow to dry for a few minutes. Repeat procedure for the other lower tail fin.

STEP 14

A. Apply white glue to the root edge of a wing. Position it on the alignment line 2.0" inch from the end of the body tube. Check to be sure it is projecting out from body tube as shown. Let dry for a few minutes. Repeat procedure for the other wing.

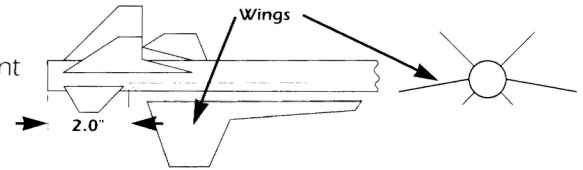

STEP 15

A. After all the glue is completely dry apply a small bead of white glue to all the wing/body tube joints. Smooth the glue out with your finger. Wipe excess glue off your finger into a tissue or paper towel.

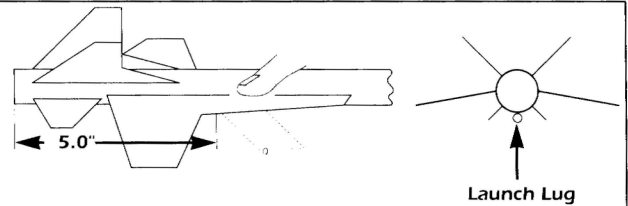

B. Apply white glue to the launch lug and place it straight along the pencil line centered between the two lower tail fins 5.0" inches from the end of the body tube as shown.

STEP 16

A. Assemble the parachute according to the instructions printed on it.

B. Firmly squeeze each gripper tab and parachute between your fingers.

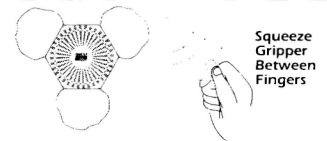

STEP 17

A. Use two overhand knots to tie the loose end of the shock cord onto the base of the nose cone.

B. Pass the shroud line loops through the eyelet on the nose cone. Pass parachute through loop ends and pull lines tightly against the eyelet.

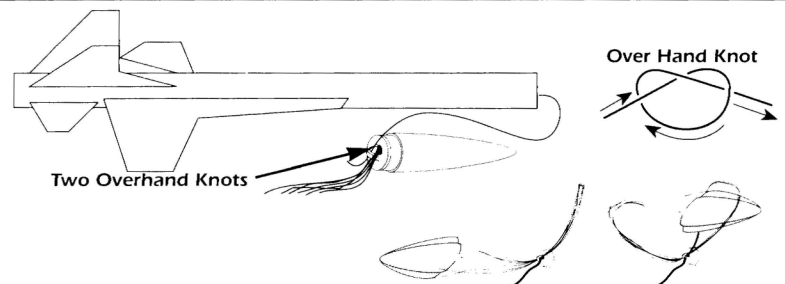

STEP 18

A. After all the glue is completely dry apply a coat of sanding sealer to each fin. When sealer is dry, lightly sand each fin.

B. Repeat the sealing and sanding process until the surface of each balsa part is smooth.

C. Paint the entire rocket with gloss white spray enamel. Follow instructions on spray can for best results.

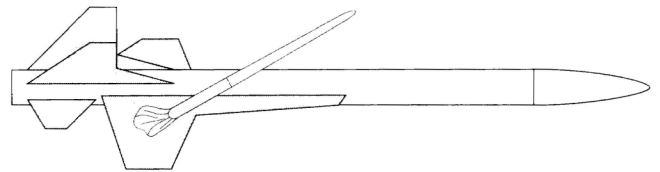

STEP 19 USE THESE PICTURES AS YOUR GUIDE FOR PLACEMENT AND FOLLOW THESE STEPS TO APPLY THE DECALS

A. Use your hobby knife to cut out the decals. Make a smooth continuous cut all the way through the backing sheet. Cut out names and words as a block. Small knicks can cause the decal to tear as you peel it off the backing sheet. Carefully peel off each decal (hold small decals with a pair of tweezers). Dip decals into a bowl of warm water containing a drop of dish wash detergent. Position the decal on the rocket. Use a tissue to gently press air bubbles out from under the decal. After all decals are positioned and have dried, spray the entire rocket with a coat of clear gloss.

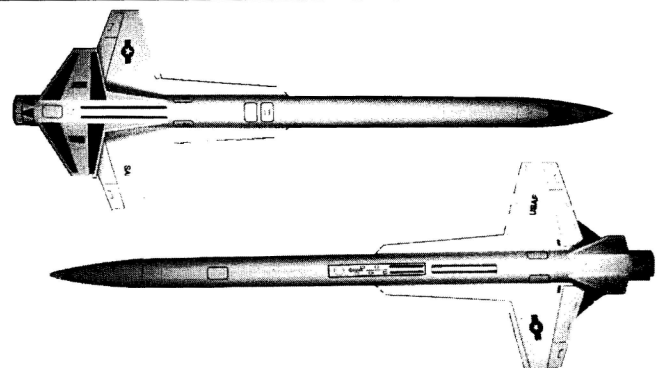

FLYING YOUR INTRUDER ROCKET

WHAT ELSE YOU WILL NEED:

To successfully fly your rocket you will need the following items:

- QUEST Launch Pad (No. 7600)
- QUEST Launch Controller (No. 7500)
- QUEST Parachute Recovery Wadding (No. 7020)
- QUEST Rocket Motors, Type A6-4, B6-4, C6-5, or C6-7
- Use a A6-4 Motor for your first flights.

ESTIMATED ALTITUDES

The following is a guide to assist you in determining which motor to use based on the wind conditions and size of flying field available.

MOTOR	ESTIMATED ALTITUDE
A6-4	200 FEET
B6-4	350 FEET
C6-5	750 FEET
C6-7	800 FEET

PREPPING YOUR ROCKET FOR FLIGHT

STEP 1

Pull the shock cord all the way out of the body tube. Crumple three sheets of recovery wadding and insert one by one into the body tube making sure that the knot between the Kevlar and white elastic shock cord is on the nose cone side of the wadding. Wadding should fit loosely in the tube but tight enough to form a good seal against the wall of the body tube.

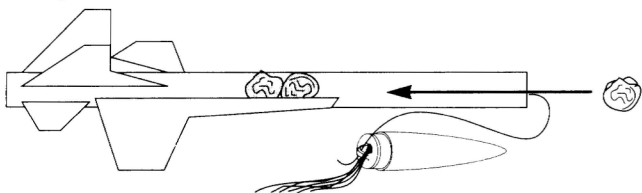

STEP 2

- Grab the parachute at its center and allow the rocket to hang from it. The weight of the rocket will pull the parachute into several triangular shapes.
- Gather the triangles together into one flat triangle.
- Fold the top of the parachute down over itself once.
- Now continue to roll the parachute over itself and roll the shroud lines around it.

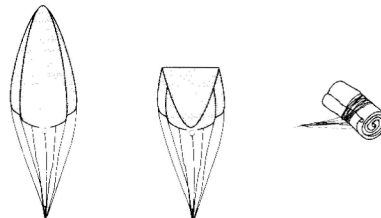

STEP 3

- Pack the parachute into the body tube. **THE PARACHUTE MUST SLIDE EASILY INTO THE TUBE.** If it is a tight fit, remove and re-fold the parachute.
TIP: LIGHTLY DUST YOUR PARACHUTE WITH TALCUM OR BABY POWDER TO KEEP IT FROM DEVELOPING A SET SHAPE. THIS TECHNIQUE IS ESPECIALLY EFFECTIVE IF THE WEATHER IS HOT AND HUMID OR VERY COLD.
- Push the shock cord into the tube and re-fit the nose cone onto the rocket. **BE CAREFUL NOT TO CATCH ANY OF THE SHOCK CORD BETWEEN THE SHOULDER OF THE NOSE CONE AND THE BODY TUBE.**

READ AND FOLLOW THE ENCLOSED LAUNCHING PROCEDURES SHEET

READ AND FOLLOW THE N.A.R. SAFETY CODE DURING ALL YOUR MODEL ROCKETRY ACTIVITIES.



IRONCLAD GUARANTEE

If for any reason, you are not totally satisfied with our product, QUEST will provide whatever you think is fair, from refund to replacement.



Manufactured by:
QUEST AEROSPACE
EDUCATION, INC.

LAUNCHING PROCEDURES

This sheet covers basic Launching Procedures for single stage model rockets with parachute or streamer recovery systems. Review your kit instructions for additional information about your model rocket. Specific details for launching multi-stage models, glider recovery vehicles or other different types of model rockets are featured in the instructions of specific kits.

STEP 1

Remove TigerTail II sticker from backing sheet.

Leave "dots" behind on sheet.

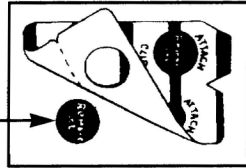

STEP 2

Center the copper igniter wire over the hole.

Be sure igniter wire is centered and visible through both holes.

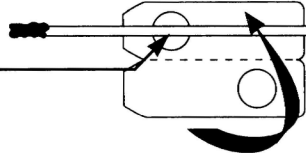

Fold TigerTail II sticker over the igniter wire.



STEP 3

Place black coated end of the igniter wire into motor nozzle as far as it will go.

Black igniter tip **MUST TOUCH** the bottom of the nozzle or motor will not ignite.

("Disregard" any message on the motor label stating "Attach TigerTail Here", as this was for an earlier version of the TigerTail igniter.)

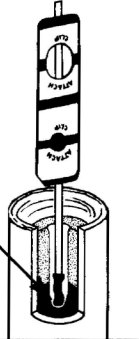

STEP 4

Push the plastic TigerTac into nozzle as far as it will go.

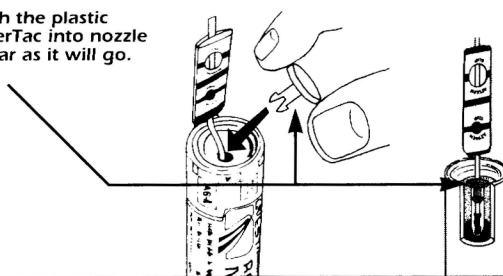

STEP 5

Attach One Micro-Clip Lead to Each Hole Where The Copper Wire is Exposed.

Tie Micro-Clip Leads to Launch Pad Leg.

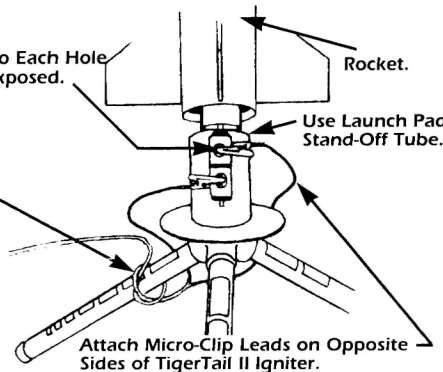

Attach Micro-Clip Leads on Opposite Sides of TigerTail II Igniter.

IMPORTANT: To Avoid a Potential Short Circuit and /or Misfire **DO NOT** Clamp Micro-Clips too Tightly to the TigerTail II Igniter

NOTE: If you are using a different brand rocket motor and the TigerTac does not fit into the nozzle, substitute the TigerTac with a 1" x 1" square of recovery wadding crumpled into a small ball and pushed into the motor nozzle with a pen or pencil tip to hold igniter wire in place.

LAUNCH SITE SELECTION: Select a large area away from tall trees, power lines and low flying aircraft. Parks, playgrounds, soccer and football fields make great launch sites. **DO NOT LAUNCH ROCKETS IN AREAS WITH BROWN GRASS, DRY WEEDS, OBSTRUCTIONS OR ANY HIGHLY FLAMMABLE MATERIALS.** The larger the launch site the easier it will be to recover your rocket. See the N.A.R. Safety Code for additional information.

NOTE: (For circular area, site dimension is the diameter in feet, for a rectangular area, it is the shortest side in feet.)

Motor Type	Installed Total Impulse (Newton-Seconds)	Minimum Site Dimensions (feet)
A	1.26 - 2.50	100
B	2.51 - 5.00	200
C	5.01 - 10.00	400

LAUNCH PREPARATIONS: (1) Parachute Recovery Wadding should be positioned between the rocket motor and the recovery system to prevent scorching of the parachute or streamer. The wadding should loosely fill the body tube for a depth of approximately two body tube diameters. Crumble the wadding loosely to get maximum bulk and a good seal against the wall of the body tube. See Recovery Wadding instructions for more information.

(2) Recheck the recovery system of your model to be sure it has been prepped and packed per its instructions. Your parachute or streamer should fit loosely inside the rocket's body tube so it can deploy easily. Lightly dust your parachute with baby or talcum powder to keep it from developing a set shape inside your rocket body tube. This technique is especially effective if the weather is hot and humid or is very cold.

(3) Check the nose cone fit to be sure it's snug, but not too tight. If it's too loose add a small piece of tape to the shoulder of the nose cone. If it's too tight lightly sand the shoulder of the nose cone and/or stretch the end of the body tube slightly by inserting the pointed end of the nose cone into the body tube and gently twist it back and forth a few times.

(4) To select the correct rocket motor consult the current Quest Catalog, product packaging or instruction sheet for recommended rocket motors to use in your model. Follow all igniter and rocket motor installation procedures.

(5) Install the TigerTail II Igniter into the rocket motor per the TigerTail II Igniter instructions.

(6) When placing the rocket motor into the easy-lock motor mount be sure the motor mount clip is securely positioned over the end of the rocket motor.

(7) Unwind the wire leads from your Launch Controller and place the controller the full length of the wire leads away from the launch pad (at least 15 feet). Be sure the launch controller is disarmed and is in good working condition. Micro-clips must be clean. **ATTACH THE CONTROLLER'S MICRO-CLIP LEADS TO THE LAUNCH PAD BY TYING THEM TO ONE OF THE LAUNCH PAD LEGS WITH A SINGLE OVER HAND KNOT.** Micro-clip lead wire should be pulled apart so each individual micro-clip lead is 6 inches to 8 inches long.

(8) ALWAYS USE CAUTION WHEN BENDING OVER YOUR LAUNCH PAD TO AVOID EYE INJURY. Remove the launch rod safety cap and lower the rocket onto the launch pad positioning it on the Launch Rod Stand-Off several inches above the blast deflector. The launch lug on the rocket's body tube should glide easily over the launch rod. Check to be sure there are no rough surfaces or obstructions on the launch rod which could hinder the lift-off of the model. For eye safety keep the tip of the launch rod covered with the Launch Rod Safety Cap until you are just ready to begin the countdown.

(9) Be sure the Safety Key is with you before hooking up the micro-clips to the TigerTail II Igniter. Attach one micro-clip lead to each hole in the TigerTail II Igniter where the copper wire is exposed. The micro-clips **MUST NOT** touch each other or the blast deflector. Use the Launch Rod Stand-Off, an empty motor casing or piece of tape wrapped around the launch rod to position the rocket several inches above the blast deflector to keep the micro-clips from touching it and shorting out. For best results bring one micro-clip lead around each side of the Launch Rod Stand-Off and hook up to TigerTail II Igniter.

COUNT DOWN PROCEDURE: (1) When your rocket is ready to launch be sure you and all spectators are standing at least 15 feet away from the launch pad. (2) Make sure the sky is clear of low flying aircraft. Wind conditions should be gentle. Be sure you have the attention of all individuals in the launching and recovery areas. (3) Arm your Launch Controller with the Safety Key. The arming light should go on. If arming light does not go on check battery power, electrical connections and igniter installation. Clean micro-clips with sand paper if necessary (4) With rocket armed announce to the spectators in a loud voice, "the rocket is armed, and counting...5...4...3...2...1...Lift-Off!" (5) Push the launch button down momentarily until the rocket motor begins thrusting, then release it. The rocket should lift-off from the launch pad almost instantly. (6) **BE SURE AND REMOVE THE SAFETY KEY FROM THE LAUNCH CONTROLLER AS SOON AS THE ROCKET LIFTS-OFF. KEEP THE SAFETY KEY WITH YOU AT ALL TIMES.** (7) **REPLACE THE LAUNCH ROD SAFETY CAP IN BETWEEN LAUNCHINGS.**

RECOVERY PROCEDURE: (1) Track the flight of your rocket until the recovery system is deployed and the rocket is returning gently back to Earth. (2) If the rocket appears to be drifting away from the launch area keep your eyes on it until it touches down. (3) If the recovery system malfunctions be prepared to alert the spectators that the rocket is returning to Earth faster than normal and to be "heads-up" and aware of the area where the rocket is falling to.

MISFIRE PROCEDURE: (1) Occasionally, at the end of the countdown the rocket will fail to lift-off because the rocket motor did not ignite. This usually occurs because the igniter was not making the proper contact with the surface of the rocket motor's propellant. (2) Disarm the launch controller and wait one minute before approaching the launch pad. (3) If arming light glows, but motor does not ignite, try repositioning the micro-clips on the TigerTail II Igniter and repeat the countdown procedure. (4) If rocket motor still does not ignite, disarm the launch controller, wait one minute before approaching the pad, then remove the model from the launch pad. (5) Remove the TigerTail II Igniter from the motor nozzle, clean the micro-clips and install a new TigerTail II Igniter. (6) Repeat the countdown procedure again.

BATTERY TEST: If batteries are weak replace them. Battery strength can be tested by attaching both micro-clips together and inserting the Safety Key. The arming light should glow brightly. Batteries are weak if light is deem. **Be sure to use alkaline type batteries for best results.**

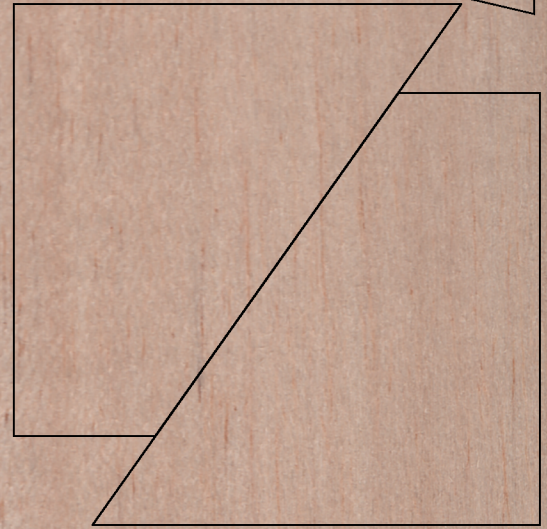
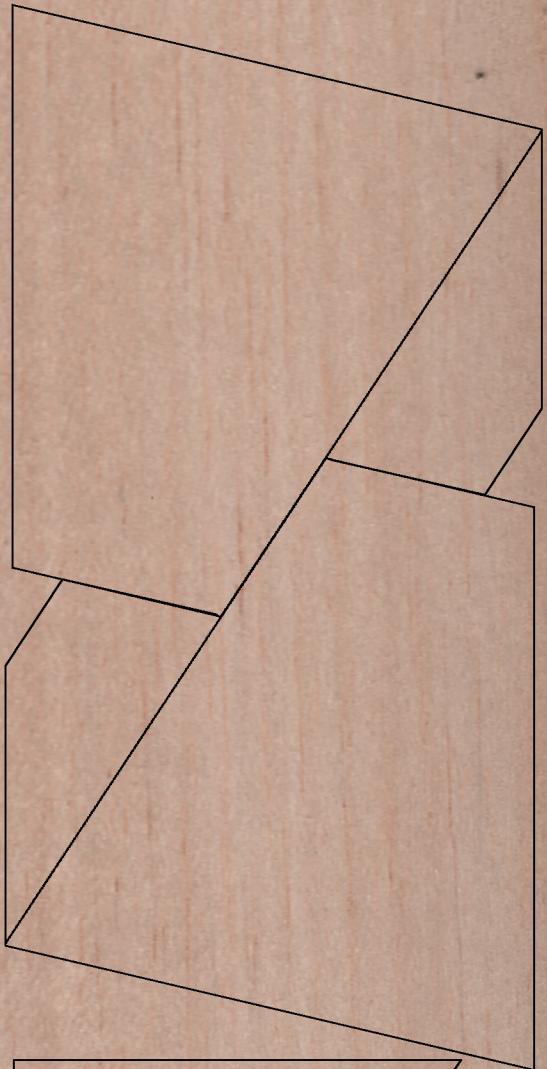

3/32"

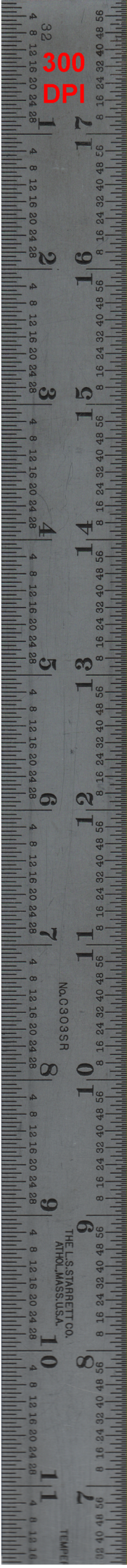

**300
DPI**

No. C303SR

THE L.S. STARETT CO.
ATHOL, MASS., U.S.A.

TEMPER

300
DPI

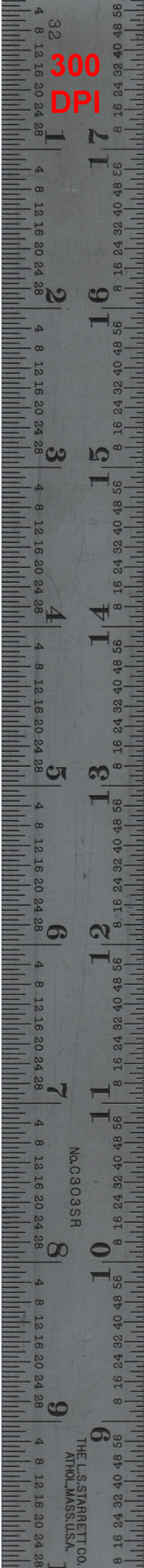

NaC303SR

THE U.S. STARETT CO.
ATHOL, MASS., U.S.A.



UNITED STATES
UNITED STATES

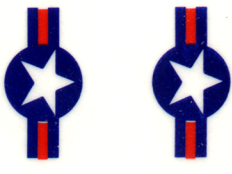
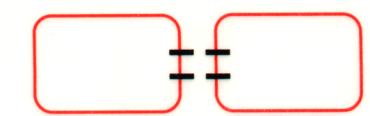
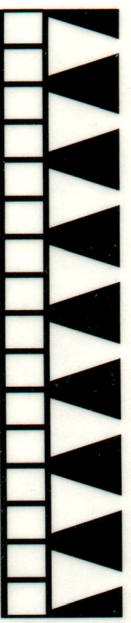

USAF USAF

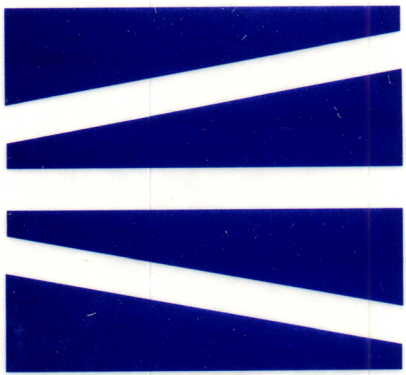
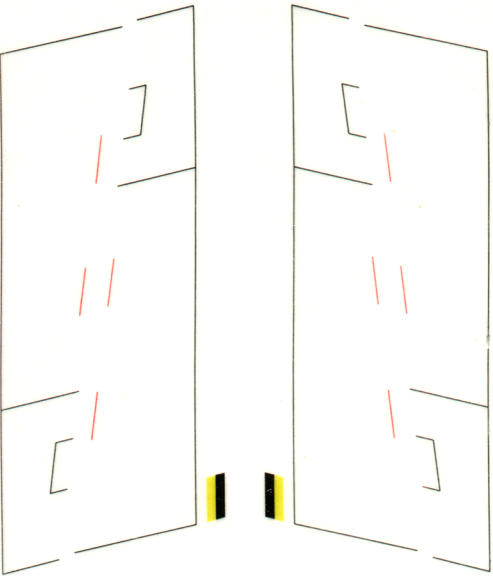
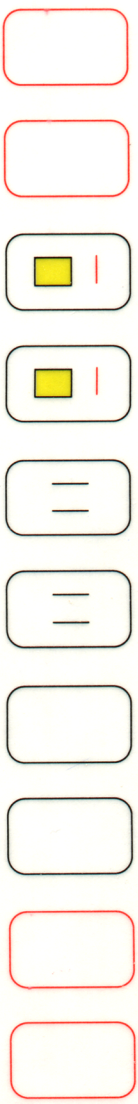

91006

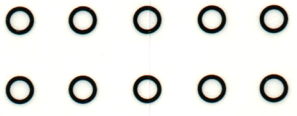

QUEST
Shaping the future of model recovery

Flying Model Rocket Skill Level 3 Kit For Advanced Modelers

Intruder

- Flies up to 800 ft. (244 m)
- 1/4" dia. parachute recovery
- Die-cut balsa fins



This kit requires assembly, sanding, glue, plastic cement, finishing supplies, and a system of rocket motors for launch. Only one rail is included.

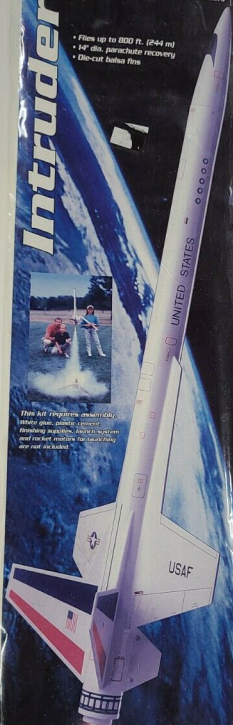

Item No. 3001

Length: 19.25" (48.9 cm)
Dia.: 1.25" (31.8 mm)
Weight: 1.3 oz. (37 g)
Motors: A6-4 (first flight)
B6-4, C6-3, C6-5
Assembled in Mexico



recommended for ages 15 and up. Not suitable for children under 15. Recommended for use only if you have read the instructions and are familiar with the use of model rockets.

Parts lists can be obtained from Quest. For more information, visit our website at www.questmodel.com. See our website for more information. See our website for more information. See our website for more information.

QUEST
Shaping the future of model recovery

Quest America, Inc.
1000 E. Center Street
San Diego, CA 92101 USA
www.questmodel.com

Quest Model, Inc. may vary from the actual product.



INSTRUCTIONS

What You'll Need to Assemble This Kit

by Kevic, Perck and Paire Bush

paper with 100-grit sanding paper

1/4" Glue

and both glue work best with the 1/4" dia. balsa fin. Use the 1/4" dia. balsa fin. Use the 1/4" dia. balsa fin.

1/4" Cement

EPORS™ Tube Paste, Cement, FACTSA™ LIQUID CEMENT™ are compatible brands.

1/4" Paint

1/4" Mask, Tape or Tack, Masking Tape and Sand Paper

1/4" Tweezers and Wax Paper

READ THESE INSTRUCTIONS. IT IS BEST TO TEST FIT ALL PARTS AND FOLLOW THE NAS MODEL ROCKET SAFETY CODE.



INTRUDERTM

Flying Model Rocket

- Full-size, Intruder™ series! Thousands of Intruder™ rockets!
- Comes with a full complement of parts for maximum fun!
- Includes quality engineered high quality motorized launchers, like the Motorized and Igniter™ launchers (sold separately).
- Features wings, motor case, and launchers for easy use!



The Intruder™ rocket is designed for maximum fun!

For more information about Intruder™ rockets, call 1-800-4-A-Rocket today!

Model Rocket
Includes:
- 1 Motor Case
- 1 Igniter
- 1 Launch Pad
- 1 Rocket
- 1 Motor
- 1 Igniter
- 1 Launch Pad



1 Primary Parachute

