



WORLD LEADER IN MODEL ROCKETRY



2015

TABLE OF CONTENTS

How To Start	3
What to Know	4
Model Rocket Safety Code	5
New	6-13
ARF	6
Pro Series II E2X®	6
E2X®	8
Skill Level 2-5	12
Pro Series II	14
Air Powered Rockets	26
Launch Sets	20
Ready To Fly Rockets	28
Almost Ready To Fly Rockets	36
E2X® (Easy To Assemble)	42
Skill Level 1	54

220 Swift™	54	Firestreak™ SST	42	Planet Purple™	28
3 Bandits™	50	Firestreak SST™ Bulk Pack	87	Power Patro™	36
AGM-57X Heatseeker™	46	Firestorm™	38	Prospector™	32
Air Commander™	66	Flash!™ Launch Set	24	Prowler Launch Set™	14
Alien Green™	28	Fletcher™	58	Pulsar Pink™	28
Alpha™	54	Flip Flyer™	10	QCC Explorer™	74
Alpha™ Bulk Pack	88	Flutter-By™	60	Rascal™ & Hijinks™ Launch Set	20
Alpha III®	42	Flying Colors™	38	Red Flare™	44
Alpha III® Bulk Pack	87	Fractured™	40	Red Rider™	38
Alpha III® Launch Set	22	Freefall™	44	Riptide™ Launch Set	20
Altimeter	81	Fuse™	32	Rocket Red™	28
Argent™	16	Galaxy Gold™	28	Rocket-Star™ Air Rocket Launch Set	26
Ascender™	14	Generic E2X®	10	Rogue Voyager™	70
Asteroid Hunter™	74	Generic E2X® Bulk Pack	87	Rookie™	7
Astron Elliptic II™	64	Gnome™ Bulk Pack	87	Satellite Silver™	28
Astron Skydart II™	72	HeliCat™ Launch Set	22	Savage™	50
Astron Sprint XL™	70	Hi-Flier®	58	Scorpion™	12
Athena™	32	Hi-Flier XL™	68	Shattered™	50
Atomic Aqua™	28	Hijinks™	30	Shooting Star™	36
Atomic Sky™ Launch Set	20	Hornet™	60	Show Stopper™	10
AVG™ Bulk Pack	87	Humdinger™	48	Shuttle Xpress™	48
Baby Bertha™	54	Hunter's Choice Launch Set	20	Silver Arrow Launch Set	22
Bandito™	42	Hyper Bat™	70	Silver Streak™	20
Banshee™	46	Hyper Dart™	40	Sizzler™	34
Big Bertha™	56	JBR-013™	68	Sky Cruiser™	10
Big Daddy™	64	Laser Lance™	66	Sky Duster™	34
Black Diamond™	52	Leviathan™	16	Sky Hawk™	30
Black Hole™	28	L.G.M. 0095™	36	Sky Shark™	52
Black Star Voyager™	74	LoadStar II™	68	SkyTrax™	32
Blast Jets™	26	LoadStar II™ Bulk Pack	88	Sky Twister™	44
Blast-off Blue™	28	Longneck Express™	34	Sky Twister™ Launch Set	22
Blenders™	68	Lynx™	12	Solar Scouts™ Launch Set	24
Booster-55	38	Magician™	72	Solar Warrior™	66
Booster-60	38	Majestic™	36	Solaris™	36
Bull Pup 12D	68	Mammoth™	6	Spectra™	40
Centuri™	68	Manta II™ Launch Set	22	Spirit™	40
Chiller™	40	Maxi Alpha™ 3 Launch Set	24	Splendor™	52
Chuter-Two™	60	Mega Der Red Max™	16	Star Trooper™	60
Cobra™	72	Mercury Redstone™	12	STM-012™	70
Code Red™	32	Metalizer™	46	Stratocruiser™	62
Color the Skys™ Bulk Pack	87	Meteorite White™	28	Super Neon XL™	72
Comet Chaser™ Bulk Pack	88	Mini Comanche-3™	64	T-Bolt™ Air Rocket Launch Set	26
Conquest™	74	Mini Fat Boy™	58	Tandem-X™ Launch Set	24
Cosmic Explorer™	58	Mini Honest John	58	Taser™ Launch Set	24
Cosmic Interceptor™	74	Mini Max™	58	Taser Twin™	60
Crossbow SST™	12	MIRV™	72	Trajector™	14
Crossfire ISX™	62	Mix-it UP™	48	Tercel™ Boost Glider	72
Curvilinear™	62	Mix-n-Match-50	8	Top Shot™	44
Dark Silver™	74	Mix-n-Match-55	8	U.S. Army Patriot M-104	56
Dark Zero™	52	Mix-n-Match-60	8	UP Aerospace™ SpaceLoft™ Bulk Pack	87
Dazzler™	40	Mongoose™	56	V2 Semi-scale Model	72
Der Red Max™	54	Mosquito™	56	Vagabond™	66
Designer Special™	90	Nike Smoke™	16	Ventris™	16
Dink™	48	Nitro™	34	Viking™	56
Dragonite™	46	No. 2 Estes Sky Writer®	42	Viking™ Bulk Pack	88
Drifter™	40	Nova™	7	Volt™	26
Eggsaliber™	64	Odyssey™	12	Whirlwind™	26
Emerald Streak™	52	Orange Crush™	48	Wizard™	54
EPM-010™	70	Outer-space Orange™	28	Wizard™ Bulk Pack	88
Estes Jetliner™	62	Outlaw™	34	Xarconian Cruiser™	74
EX-200™	30	Partizon™	16	Yankee™	54
Eliminator XL™ Launch Set	20	Patriarch™	30	Yellow Star™	28
Extreme 12™	72	Phantom Blue™	36	Zolt™	26
Fat Jax™	34	Phoenix Bird™	60	Zinger™	50
Firehawk™	42	Photon Probe™	66		
Firebolt™	46				

Prices and availability are subject to change without notice. Color of product may vary.

© 2014 Estes-Cox Corp., 1295 H Street, PO Box 227, Penrose, CO 81240-0227. A subsidiary of Hobbico, Inc. All rights reserved. Printed in Denver, CO, USA. PN2927-15 (12-14)



HOW DO I START MY OWN ESTES ROCKET FLEET?

The best way to begin model rocketry is with an Estes flying model rocket launch set. Most of our launch sets are from the E2X® (Easy To Assemble) line. The rocket itself requires minor assembly. All launch sets come with an electrical launch controller, launch pad and instructions to get you out and flying in no time. You will need to purchase flight supplies (engines, recovery wadding, starters and starter plugs) and new alkaline batteries (for the controller) – sold separately.

HOW EASY AND HOW MUCH TIME DOES IT TAKE TO BUILD MY ROCKETS?

Estes model rocket kits range from ready to fly in just minutes to those that provide many enjoyable hours of building fun. Estes kits are classified into eight categories. **READY TO FLY (RTF):** No paint, glue or modeling skills required. Rocket comes assembled and is ready to launch in minutes.

ALMOST READY TO FLY (ARF): Very minor assembly required and is ready to launch in just a few minutes.

E2X® (EASY TO ASSEMBLE): No paint or special tools needed. E2X® kits contain parts that are pre-colored, easy to assemble, plastic fins or fin units and plastic nose cones. Glue the parts together as instructed, apply the self-stick decals and attach the recovery system.

Skill Level 1: Requires some painting, gluing and sanding. Features laser cut wood fins, plastic or balsa nose cones, self-stick or waterslide decals, unfinished body tubes and step-by-step instructions. Most kits are single stage rockets.

Skill Level 2: First tier of more advanced kits that require beginner skills in model rocket construction, finishing and painting. Features laser cut wood fins, plastic or balsa nose cones, self-stick or waterslide decals, unfinished body tubes and step-by-step instructions. These are unique designs that include multi-stages, payloads and scale models.

Skill Level 3: Second tier of more advanced kits that require moderate skills in model rocket construction, finishing and painting. Features multiple laser cut wood fins and parts, unfinished body tubes, waterslide decals, balsa or plastic nose cones, vacuum-formed plastic detailing and step-by-step instructions. These complex designs include scale models, payloaders and multi-stagers that can use D and E engines.

Skill Level 4: Requires a high degree of construction and finishing skills. Features multiple laser cut wood fins, unfinished body tubes and waterslide decals. Assembly can take several days depending on the details required.

Skill Level 5: The most advanced and challenging kit level. These kits are designed for very experienced, master modelers. Construction is extremely complex using advanced wood, paper and plastic techniques. Finishing is detail-oriented that may involve elaborate paint schemes. Building and finishing these rockets can take up to a week or more.

WHAT IS AN ESTES MODEL ROCKET?

Estes model rockets are activity kits designed of lightweight materials such as paper tubing, balsa wood and plastic. Fins attached to the body tube help provide guidance and stability. An engine mount assembly holds the engine in place during rocket flight in most models.

HOW DOES IT WORK?

The Estes model rocket is propelled into the air by an electrically ignited model rocket engine. After its acceleration, the rocket continues upward emitting tracking smoke as it coasts. At the rocket's peak altitude (also called apogee), a recovery device, such as a parachute or streamer, is deployed to return the rocket gently to earth. The rocket can then be prepared for another flight.

FLIGHT SEQUENCE

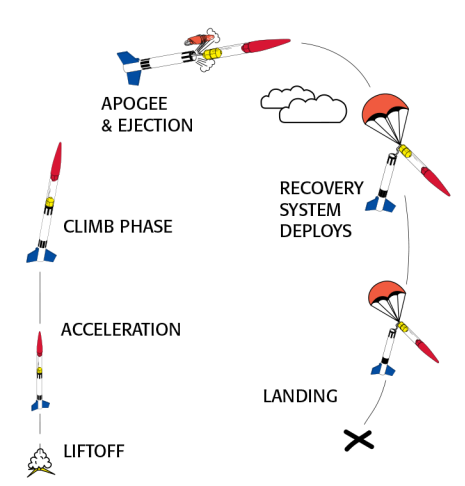

WHERE DO I FLY ESTES MODEL ROCKETS?

The chart on page 5 tells you what size field to use for each size engine. Each engine size is designated by a letter and is up to twice as powerful as the letter before it. See the engine section (pages 76-79) of this catalog for more information.



HOW DID IT ALL GET STARTED?

In the mid-1950s when the space age began, flying rockets became very popular. However, there were no propellants readily available to launch model rockets. In 1958 Vernon Estes developed the first, mass-produced model rocket engine. The Estes rocket engine was destined to make model rocketry one of the most popular outdoor activities enjoyed today. Estes products have changed with the times and you can see all of the exciting rockets in this catalog or on the web at www.estesrockets.com.

WHAT DO I NEED TO KNOW?

In this catalog, each description lists important INFORMATION:

- Specifications – length, diameter and estimated weight.
- What engines we recommend.
- How high, on the largest engine recommended, the rocket flies (feet and meters).
- Projected altitudes are estimates only and your rocket's actual performance may vary.
- The type of recovery system that brings the rocket back – parachute, streamer or other.

PARTS OF A MODEL ROCKET

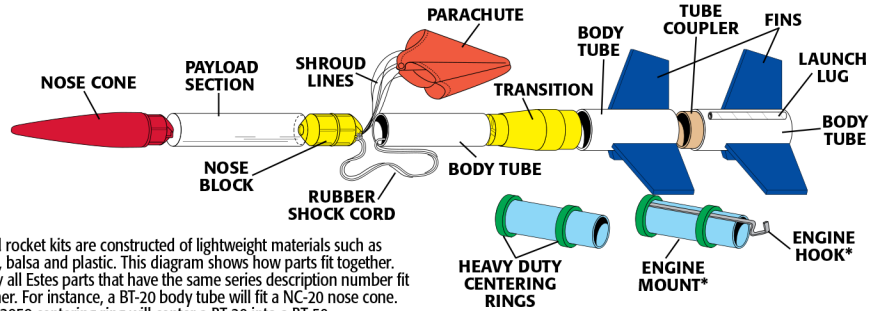

Model rocket kits are constructed of lightweight materials such as paper, balsa and plastic. This diagram shows how parts fit together. Nearly all Estes parts that have the same series description number fit together. For instance, a BT-20 body tube will fit a NC-20 nose cone. An AR2050 centering ring will center a BT-20 into a BT-50.

* Not included in RTF or E2X® kits.

PLEASE READ!

Estes model rocketry is recommended for ages 10 years and up. Adult supervision is recommended for those under 12 years of age. Unless otherwise specified, all models require assembly. Engines, recovery wadding, starters and starter plugs, launch system, glue and finishing supplies are not included with model rocket kits.

USE ONLY WITH ESTES PRODUCTS

Caution: Use of any Estes product with any other brand-name rocket product containing any defect or causing any damage may void the Estes warranty.



FULL ONE-YEAR WARRANTY

Your Estes model rocket product is warranted against defects in materials or workmanship for one year from the date of the original purchase. If this Estes product, because of a manufacturing mistake, malfunctions or proves to be defective within the one-year warranty period, it will be repaired or replaced, at Estes' option and at no charge to you.

This warranty does not cover incidental or consequential damage to persons or property caused by the use, abuse, misuse, failure to comply with operating instructions or improper storage of the warranted products. Some states do not allow the exclusion or limitation of incidental or consequential damages, so the above exclusion may not apply to you. This warranty gives you specific legal rights and you may also have other rights which vary from state to state.

For repair or replacement under this warranty, please contact us at www.estesrockets.com or by mail at Estes-Cox Corp., Customer Service Department, 1295 H Street, PO Box 227, Penrose, Colorado 81240-0227.

1. Materials. I will use only lightweight, non-metal parts for the nose, body, and fins of my rocket.

2. Motors. I will use only certified, commercially-made model rocket motors, and will not tamper with these motors or use them for any purposes except those recommended by the manufacturer.

3. Ignition System. I will launch my rockets with an electrical launch system and electrical motor starters. My launch system will have a safety interlock in series with the launch switch, and will use a launch switch that returns to the "off" position when released.

4. Misfires. If my rocket does not launch when I press the button of my electrical launch system, I will remove the launcher's safety interlock or disconnect its battery, and will wait 60 seconds after the last launch attempt before allowing anyone to approach the rocket.

5. Launch Safety. I will use a count-down before launch, and will ensure that everyone is paying attention and is a safe distance of at least 15 feet away when I launch rockets with D motors or smaller, and 30 feet when I launch larger rockets. If I am uncertain about the safety or stability of an untested rocket, I will check the stability before flight and will fly it only after warning spectators and clearing them away to a safe distance. When conducting a simultaneous launch of more than ten rockets I will observe a safe distance of 1.5 times the maximum expected altitude of any launched rocket.

6. Launcher. I will launch my rocket from a launch rod, tower, or rail that is pointed to within 30 degrees of the vertical to ensure that the rocket flies nearly straight up, and I will use a blast deflector to prevent the motor's exhaust from hitting

the ground. To prevent accidental eye injury, I will place launchers so that the end of the launch rod is above eye level or will cap the end of the rod when it is not in use.

7. Size. My model rocket will not weigh more than 1,500 grams (53 ounces) at liftoff and will not contain more than 125 grams (4.4 ounces) of propellant or 320 N-sec (71.9 pound-seconds) of total impulse.

8. Flight Safety. I will not launch my rocket at targets, into clouds, or near airplanes, and will not put any flammable or explosive payload in my rocket.

9. Launch Site. I will launch my rocket outdoors, in an open area at least as large as shown in the accompanying table, and in safe weather conditions with wind speeds no greater than 20 miles per hour. I will ensure that there is no dry grass close to the launch pad, and that the launch site does not present risk of grass fires.

LAUNCH SITE DIMENSIONS

Installed Total Impulse (N-sec)	Equivalent Motor Type	Minimum Site Dimensions (ft.)
0.00-1.25	1/4A, 1/2A	50
1.26-2.50	A	100
2.51-5.00	B	200
5.01-10.00	C	400
10.01-20.00	D	500
20.01-40.00	E	1,000
40.01-80.00	F	1,000
80.01-160.00	G	1,000
160.01-320.00	Two Gs	1,500

10. Recovery System. I will use a recovery system such as a streamer or parachute in my rocket so that it returns safely and undamaged and can be flown again, and I will use only flame-resistant or fireproof recovery system wadding in my rocket.

11. Recovery Safety. I will not attempt to recover my rocket from power lines, tall trees, or other dangerous places.

www.nar.org

Important Note: G motors must be sold to and used by adults (18 and up) only.

ALMOST READY TO FLY ROCKETS

2497 Nova™

Length: 20.6 in (52.3 cm)
Diameter: 1.33 in (34 mm)
Estimated Weight: 2.5 oz (70.9 g)
Recovery: Parachute
Projected Altitude: 700 ft (213 m)
Recommended Engines: B6-2 (First Flight), C6-3, C6-5

2498 Rookie™

Length: 23.3 in (59.2 cm)
Diameter: 1.64 in (42 mm)
Estimated Weight: 3.6 oz (102 g)
Recovery: Parachute
Projected Altitude: 550 ft (168 m)
Recommended Engines: B6-2, B6-4 (First Flight), C6-3, C6-5

PRO SERIES II™ E2X® (EASY TO ASSEMBLE) ROCKET KIT

9708 Mammoth™

Length: 59.5 in (151.1 cm)
Diameter: 2 in (5.1 cm)
Estimated Weight: 11.9 oz (337.4 g)
Recovery: Parachute
Projected Altitude: 1600 ft (488 m)
Recommended Engines: E16-4, E16-6, E16-8, F15-6 (First Flight), F15-8



NEW! 2497 Nova™



NEW! 2498 Rookie™

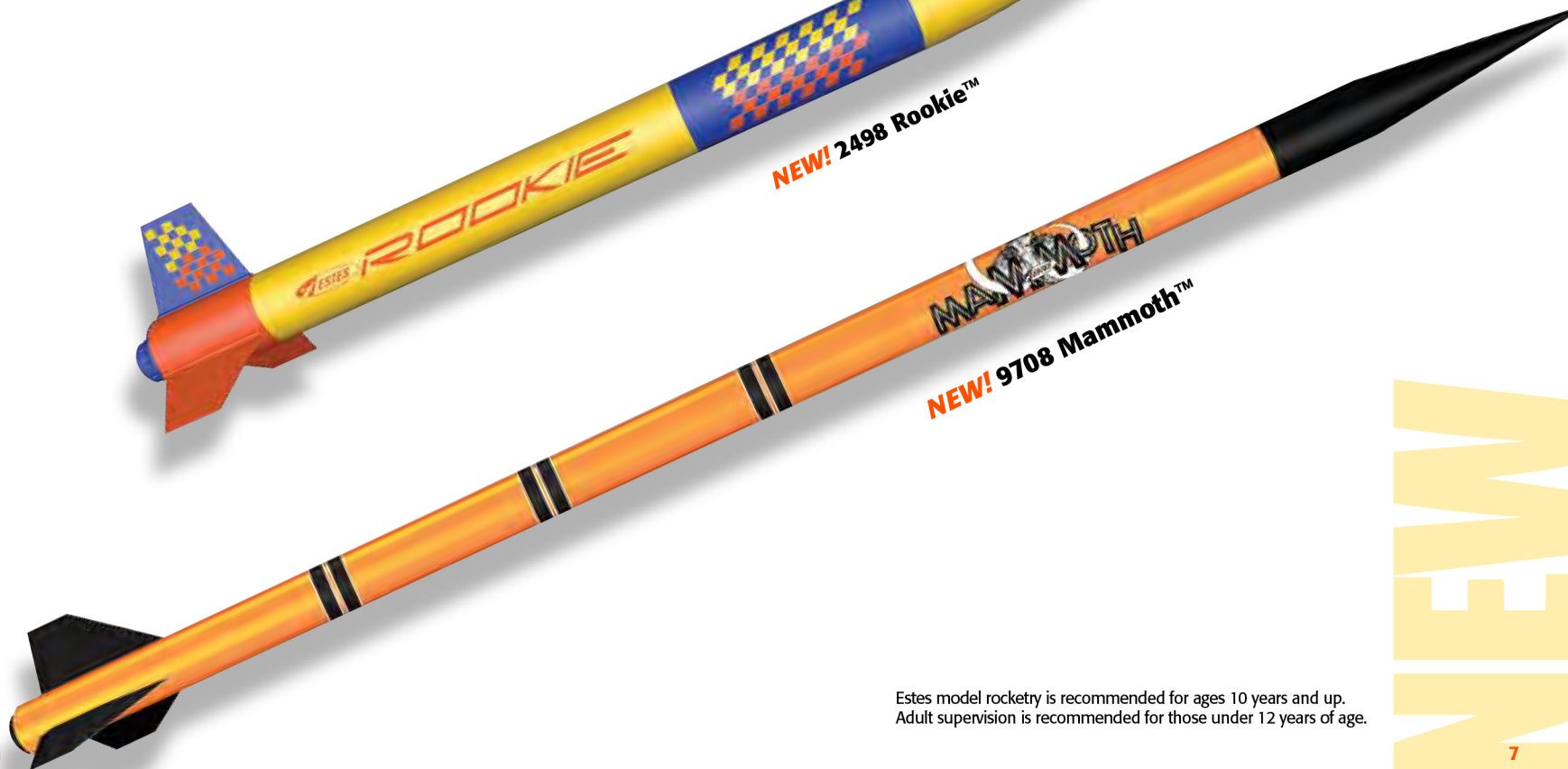

NEW! 9708 Mammoth™

E2X® (EASY TO ASSEMBLE) ROCKET KITS

The Mix-n-Match kits contain enough parts to build up to 3 rockets with 100s of possible color combinations. See page 9 for some ideas.

2005 Mix-n-Match-50™

Length: 19.5 in (49.5 cm)
Diameter: .98 in (25 mm)
Estimated Weight: 3.5 oz (99.2 g)
Recovery: Parachute
Projected Altitude: 550 ft (168 m)
Recommended Engines: B4-2, B6-2 (First Flight), C6-3, C6-5

2006 Mix-n-Match-55™

Length: 20.6 in (52.3 cm)
Diameter: 1.33 in (34 mm)
Estimated Weight: 2.5 oz (70.9 g)
Recovery: Parachute
Projected Altitude: 700 ft (213 m)
Recommended Engines: B6-2 (First Flight), C6-3, C6-5

2007 Mix-n-Match-60™

Length: 23.3 in (59.2 cm)
Diameter: 1.64 in (42 mm)
Estimated Weight: 3.6 oz (102 g)
Recovery: Parachute
Projected Altitude: 550 ft (168 m)
Recommended Engines: B6-2, B6-4 (First Flight), C6-3, C6-5



Estes model rocketry is recommended for ages 10 years and up. Adult supervision is recommended for those under 12 years of age.

E2X® (EASY TO ASSEMBLE) ROCKET KITS

2008 Generic E2X™

Length: 13.6 in (34.5 cm)
Diameter: .98 in (25 mm)
Estimated Weight: 3.2 oz (90.7 g)
Recovery: Helicopter, Parachute
Projected Altitude: 900 ft (274 m)
Recommended Engines: 1/2A6-2, A8-3 (First Flight), A8-5, B4-4, B6-4, B6-6, C6-5, C6-7

2416 Flip Flyer™

Length: 19.2 in (48.8 cm)
Diameter: .98 in (25 mm)
Estimated Weight: 3.2 oz (90.7 g)
Recovery: Helicopter, Parachute
Projected Altitude: 900 ft (274 m)
Recommended Engines: B6-2 (First Flight), B6-4, C6-5

2466 Show Stopper™

Length: 26.2 in (66.5 cm)
Diameter: 1.64 in (42 mm)
Estimated Weight: 4 oz (113.4 g)
Recovery: Parachute
Projected Altitude: 875 ft (267 m)
Recommended Engines: C11-3 (First Flight), C11-5, D12-5, D12-7

2468 Sky Cruiser™

Length: 29 in (73.7 cm)
Diameter: .98 in (25 mm)
Estimated Weight: 1.9 oz (53.9 g)
Recovery: Parachute
Projected Altitude: 1000 ft (305 m)
Recommended Engines: B4-4, B6-4 (First Flight), C6-5

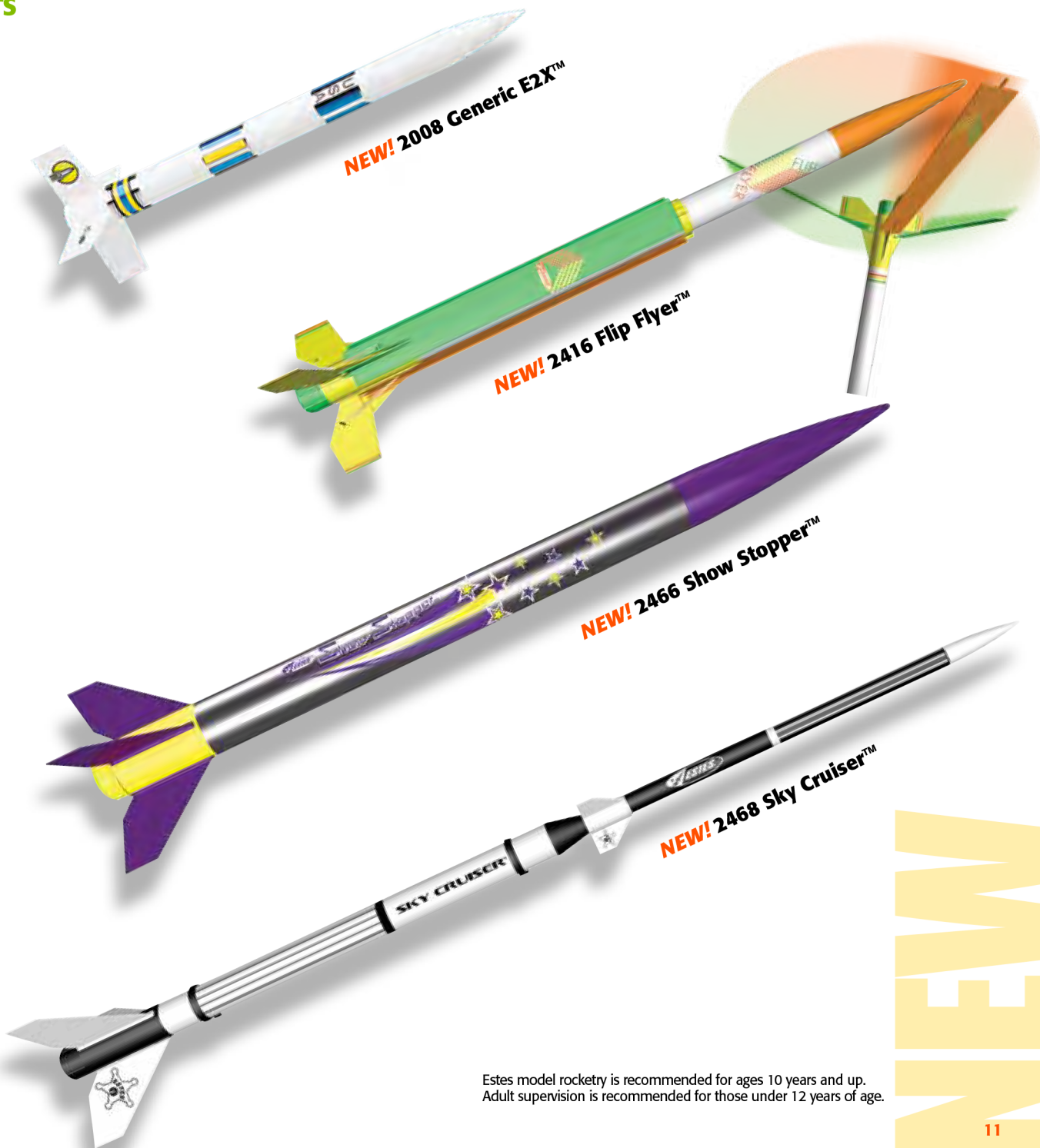

Estes model rocketry is recommended for ages 10 years and up.
Adult supervision is recommended for those under 12 years of age.

SKILL LEVEL 2 ROCKET KITS

7234 Crossbow SST™

Length: 15 in (38.1 cm)
Diameter: .74 in (19 cm)
Estimated Weight: 1.1 oz (31.2 g)
Recovery: Parachute
Projected Altitude: 1600 ft (488 m)
Recommended Engines: A8-3 (First Flight),
B6-4, C6-5

SKILL LEVEL 3 ROCKET KITS

1921 Mercury Redstone™

Length: 28.8 in (73.2 cm)
Diameter: 2.04 in (52 cm)
Estimated Weight: 3.3 oz (93.6 g)
Recovery: Parachute
Projected Altitude: 500 ft (152 m)
Recommended Engines: C6-3

7232 Scorpion™

Length: 13.4 in (34 cm)
Diameter: .74 in (19 cm)
Estimated Weight: 1.1 oz (31.2 g)
Recovery: Parachute
Projected Altitude: 400 ft (122 m)
Recommended Engines: A3-4T (First Flight), A10-3T

7233 Lynx™

Length: 13 in (33 cm)
Diameter: .74 in (19 cm)
Estimated Weight: 1.2 oz (34 g)
Recovery: Parachute
Projected Altitude: 400 ft (122 m)
Recommended Engines: A3-4T (First Flight), A10-3T

SKILL LEVEL 5 ROCKET KITS

7235 Odyssey™

Length: 28.6 in (72.6 cm)
Diameter: 1.33 in (34 mm)
Wingspan: 12.8 in (32.5 cm)
Estimated Weight: 5.5 oz (155.9 g)
Recovery: Parachute
Projected Altitude: 1100 ft (335 m)
Recommended Engines: C11-3 (First Flight),
D12-5
Requires 3/16 in (5 mm) Maxi™ launch rod (2244),
sold separately.

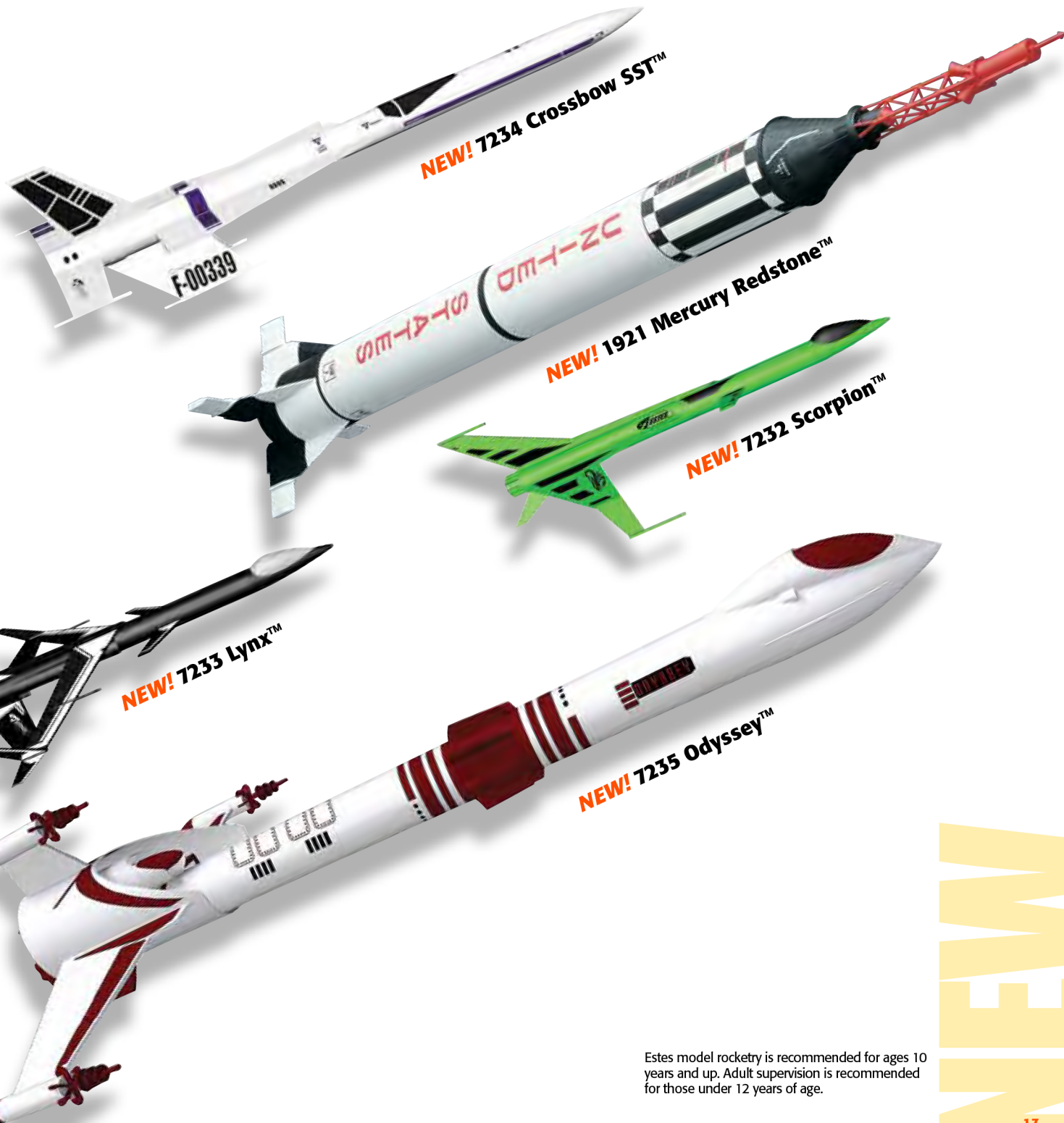

PRO SERIES II™ E2X® (EASY TO ASSEMBLE) ROCKET KITS

9706 Ascender™

Length: 42.1 in (106.9 cm)
Diameter: 2 in (5.1 cm)
Estimated Weight: 11 oz (311.8 g)
Recovery: Parachute
Projected Altitude: 2000 ft (610 m)
Recommended Engines: E16-6, F15-6 (First Flight), F15-8

9707 Majestic™

Length: 35.3 in (89.7 cm)
Diameter: 2 in (5.1 cm)
Estimated Weight: 9.6 oz (272.2 g)
Recovery: Parachute
Projected Altitude: 2000 ft (610 m)
Recommended Engines: E16-6, F15-6 (First Flight), F15-8

9709 Trajector™

Length: 35.3 in (89.7 cm)
Diameter: 2 in (5.1 cm)
Estimated Weight: 10.7 oz (303.3 g)
Recovery: Parachute
Projected Altitude: 1600 ft (488 m)
Recommended Engines: E16-6, F15-6 (First Flight), F15-8

9710 Prowler Launch Set™

Includes Estes Porta Pad E™ Launch Pad and E™ Launch Controller
Length: 33.6 in (85.3 cm)
Diameter: 2 in (5.1 cm)
Estimated Weight: 8.5 oz (241 g)
Recovery: Parachute
Projected Altitude: 2000 ft (610 m)
Recommended Engines: E16-6, E16-8, F15-6 (First Flight), F15-8



Pro Series II rockets, require a launch controller with 30 feet of wire, such as our E™ (2230) or PSII™ (2240) Launch Controller. In addition to the launch controller, you will need a sturdy launch pad with a 1/4" (6 mm) launch rod, or you can purchase our 3552 Estes Pro Series II Launch Pad.

Estes model rocketry is recommended for ages 10 years and up. Adult supervision is recommended for those under 12 years of age.

PRO SERIES II™ ROCKET KITS

9700 Leviathan™

Length: 41.5 in (105.4 cm)
 Diameter: 3 in (7.6 cm)
 Estimated Weight: 17.5 oz (496.1 g)
 Fins: Laser cut plywood
 Recovery: 24 in (60 cm) Nylon Parachute
 Projected Altitude: 1,500 ft (457 m)
 Recommended Motors: F26-6FJ, F50-6T, G40-7W, G80-7T

9701 Ventris™

Length: 46.25 in (117.5 cm)
 Diameter: 2.5 in (6.4 cm)
 Estimated Weight: 15.6 oz (442.3 g)
 Fins: Laser cut plywood
 Recovery: 24 in (60 cm) Nylon Parachute
 Projected Altitude: 2,000 ft (610 m)
 Recommended Motors: F26-6FJ, F50-6T, G40-7W, G80-7T

9702 Partizon™

Length: 56 in (142.2 cm)
 Diameter: 2.5 in (6.4 cm)
 Estimated Weight: 19.1 oz (541.5 g)
 Fins: Laser cut plywood
 Recovery: 24 in (60 cm) Nylon Parachute
 Projected Altitude: 1,800 ft (549 m)
 Recommended Motors: F26-6FJ, F50-6T, G40-7W, G80-7T

9703 Argent™

Length: 56.4 in (143.3 cm)
 Diameter: 2.5 in (6.4 cm)
 Estimated Weight: 16.5 oz (467.6 g)
 Fins: Laser cut plywood
 Recovery: 24 in (60 cm) Nylon Parachute
 Projected Altitude: 1,700 ft (518 m)
 Recommended Motors: F26-6FJ, F50-6T, G40-7W, G80-7T

9704 Nike Smoke 1 to 5.5 scale model

Length: 41.8 in (106.2 cm)
 Diameter: 3 in (7.6 cm)
 Estimated Weight: 17.5 oz (496.1 g)
 Fins: 2 piece plastic
 Recovery: 24 in (60 cm) Nylon Parachute
 Projected Altitude: 1,500 ft (457 m)
 Recommended Motors: F26-6FJ, F50-6T, G40-7W, G80-7T

9705 Mega Der Red Max™

Length: 40 in (101.6 cm)
 Diameter: 4 in (10.2 cm)
 Estimated Weight: 31 oz (878.9 g)
 Fins: Laser cut plywood with wood laminate
 Recovery: 30 in (76 cm) Nylon Parachute
 Projected Altitude: 500 ft (152 m)
 Recommended Motors: F50-6T, G40-7W, G80-7T



Pro Series II rockets require a launch controller with 30 feet of wire, such as our E™ (2230) or PSII™ (2240) Launch Controller. In addition to the launch controller, you will need a sturdy launch pad with a 1/4" (6 mm) launch rod, or you can purchase our 3552 Estes Pro Series II Launch Pad.

G motors require users to be ages 18 years and up.

PRO SERIES II™ ACCESSORIES

PRO SERIES II™ MODEL ROCKET MOTORS

(1 per pack)

9770 E30-4T Motor
9771 E30-7T Motor
9772 F26-6FJ Motor
9773 F50-4T Motor
9774 F50-6T Motor
9775 G40-4W Motor
9776 G40-7W Motor
9777 G80-7T Motor
9778 G80-10T Motor



All motors not shown.

29 mm MODEL ROCKET ENGINES

(2 per pack)

1695 E16-0
1696 E16-4
1697 E16-6
1698 E16-8
1650 F15-0
1651 F15-4
1652 F15-6
1653 F15-8



2240 PS II™ Launch Controller



2305 Sonic Igniter



2261 24 in Nylon Parachute
2273 30 in Nylon Parachute



**3172 PS II™ Shock
Cord Accessory Pack**



**3556 PS II™
Recovery Wadding**



**9750 PS II™ 29 mm
Motor Retainer Set™**



9752 PS II™ Booster

For use with rockets 9706 As-
cender™, 9707 Majestic™,
9709 Trajector™ and 9710 Prowler
Launch Set™
Recommended Engine: F15-0



**NEW 9753 PS II™
24mm to 29 mm
Engine Adapter Set**

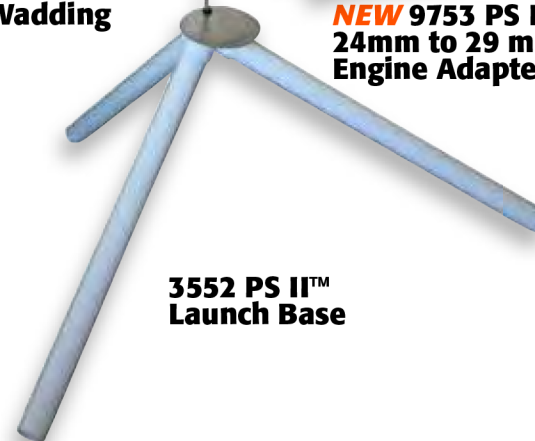

**3552 PS II™
Launch Base**

Pro Series II rockets, require a launch controller with 30 feet of wire, such as our E™ (2230) or PSII™ (2240) Launch Controller. In addition to the launch controller, you will need a sturdy launch pad with a 1/4" (6 mm) launch rod, or you can purchase our 3552 Estes Pro Series II Launch Pad.

G motors require users to be ages 18 years and up.

PRO SERIES II™

READY TO FLY LAUNCH SETS

1403 Riptide™ Launch Set

Length: 18 in (45.7 cm)
 Diameter: 1.35 in (34 mm)
 Estimated Weight: 2.7 oz (76.5 g)
 Recovery: 12 in (30.5 cm) Parachute
 Projected Altitude: 675 ft (206 m)
 Recommended Engines: B4-4 (First Flight), B6-4, C6-5

1460 Eliminator XL™ Launch Set

Length: 44.25 in (112.4 cm)
 Diameter: 1.35 in (34 mm)
 Estimated Weight: 5.6 oz (158.8 g)
 Fins: Plastic
 Recovery: 18 in (46 cm) Parachute
 Projected Altitude: 1,400 ft (427 m)
 Recommended Engines: D12-3 (First Flight), E9-6*, E9-8*
 *Requires 3/16 in (5 mm) Maxi™ Launch Rod (2244), included.

1499 Rascal™ & HiJinks™ Launch Set

Rascal™
 Length: 14 in (35.6 cm)
 Diameter: .98 in (25 mm)
 Estimated Weight: 1.5 oz (43 g)
 Recovery: 12 in (30.5 cm) Parachute
 Projected Altitude: 1,200 ft (366 m)
 Recommended Engines: A8-3 (First Flight), B4-4, B6-4, C6-5, C6-7

HiJinks™
 Length: 14 in (35.6 cm)
 Diameter: .98 in (25 mm)
 Estimated Weight: 1.5 oz (43 g)
 Recovery: 12 in (30.5 cm) Parachute
 Projected Altitude: 1,200 ft (366 m)
 Recommended Engines: A8-3 (First Flight), B4-4, B6-4, C6-5, C6-7

E2X® (EASY TO ASSEMBLE) LAUNCH SETS

1390 Atomic Sky™ Launch Set

Length: 18 in (45.7 cm)
 Diameter: .98 in (25 mm)
 Estimated Weight: 1.4 oz (39.7 g)
 Recovery: Parachute
 Projected Altitude: 1,150 ft (351 m)
 Recommended Engines: A8-3 (First Flight), B4-4, B6-4, B6-6, C6-5, C6-7

1401 Hunter's Choice™ Launch Set

Short Round™
 Length: 11.1 in (28.2 cm)
 Diameter: .74 in (19 mm)
 Estimated Weight: .74 oz (19 g)
 Recovery: Parachute
 Projected Altitude: 575 ft (175 m)
 Recommended Engines: 1/2A3-4T (First Flight), A3-4T, A10-3T

Magnum Load™

Length: 18.5 in (47 cm)
 Diameter: 1.35 in (35 mm)
 Estimated Weight: 2 oz (56.7 g)
 Recovery: 12 in (30.5 cm) Parachute
 Projected Altitude: 775 ft (236 m)
 Recommended Engines: B4-4 (First Flight), B6-4, C6-5



Each Launch Set includes Estes Launch Pad and Controller (Engines and alkaline batteries required – sold separately)

* E engines require the E™ Launch Controller (2230), sold separately.

E2X® (EASY TO ASSEMBLE) LAUNCH SETS

1424 Silver Arrow™ Launch Set

Length: 15 in (38 cm)
Diameter: .98 in (25 mm)
Estimated Weight: 1.3 oz (36.9 g)
Fins: Plastic
Recovery: 12 in (30.5 cm) Parachute
Projected Altitude: 1,125 ft (343 m)
Recommended Engines: A8-3 (First Flight), B4-4, B6-4, B6-6, C6-5, C6-7



1424 Silver Arrow™
Launch Set

1425 Manta™ II Launch Set

Length: 15 in (38 cm)
Diameter: .98 in (25 mm)
Estimated Weight: 1.3 oz (36.9 g)
Fins: Plastic
Recovery: 12 in (30.5 cm) Parachute
Projected Altitude: 600 ft (183 m)
Recommended Engines: A8-3 (First Flight), B4-4, B6-4



1425 Manta™ II Launch Set

1427 Alpha® III Launch Set

Length: 12.3 in (31.2 cm)
Diameter: .98 in (25 mm)
Estimated Weight: 1.2 oz (34 g)
Fins: Plastic
Projected Altitude: 1,150 ft (351 m)
Recovery: 12 in (30.5 cm) Parachute
Recommended Engines: A8-3 (First Flight), A8-5, B4-4, B6-4, B6-6, C6-5, C6-7



1427 Alpha® III Launch Set

1438 Sky Twister™ Launch Set

Length: 21.3 in (54.1 cm)
Diameter: 1.35 in (34 mm)
Estimated Weight: 2.9 oz (82.2 g)
Fins: Plastic
Recovery: 12 in (30.5 cm) Parachute and helicopter nose cone
Projected Altitude: 650 ft (198 m)
Recommended Engines: B4-2, B6-2 (First Flight), B6-4, C6-3, C6-5



1438 Sky Twister™ Launch Set

1465 HeliCat™ Launch Set

Length: 30.25 in (76.8 cm)
Diameter: 1.35 in (34 mm)
Estimated Weight: 3.5 oz (99 g)
Fins: Plastic
Recovery: 18 in (46 cm) Parachute; Nose Cone - Helicopter
Projected Altitude: 550 ft (168 m)
Recommended Engines: B4-2, B6-2 (First Flight), C6-3, C6-5



1465 HeliCat™ Launch Set

Each Launch Set includes Estes Launch Pad and Controller (Engines and alkaline batteries required – sold separately)

Estes model rocketry is recommended for ages 10 years and up. Adult supervision is recommended for those under 12 years of age.

E2X® (EASY TO ASSEMBLE) LAUNCH SETS

1469 Tandem-X™ Launch Set Amazon™

Length: 29.4 in (74.7 cm)
Diameter: 1.33 in (34 mm)
Estimated Weight: 3.2 oz (90.7 g)
Fins: Plastic
Recovery: 18 in (46 cm) Parachute
Projected Altitude: 600 ft (183 m)
Recommended Engines: B4-2 (First Flight), B4-4, B6-2,
B6-4, C6-3, C6-5

Crossfire ISX™ Skill Level 1

Length: 15.6 in (39.6 cm)
Diameter: .98 in (25 mm)
Estimated Weight: 1.3 oz (37 g)
Fins: Laser cut wood
Recovery: 12 in (30.5 cm) Parachute
Projected Altitude: 1150 ft (351 m)
Recommended Engines: A8-3 (First Flight), B4-4,
B6-4, C6-5, C6-7

1475 Solar Scouts™ Launch Set Sky Dart™

Length: 10.3 in (26.2 cm)
Diameter: .54 in (14 mm)
Estimated Weight: .4 oz (11.3 g)
Fins: Plastic
Recovery: Streamer
Projected Altitude: 950 ft (290 m)
Recommended Engines: 1/2A3-2T (First Flight), 1/2A3-4T,
A3-4T, A10-3T

Farside™

Length: 16.5 in (41.9 cm)
Diameter: 1.1 in (28 mm)
Estimated Weight: 1.6 oz (45.4 g)
Fins: Plastic
Recovery: 12 in (30.5 cm) Parachute
Projected Altitude: 1,100 ft (335 m)
Recommended Engines: A8-3 (First Flight), B4-4, B6-4, B6-6,
C6-5, C6-7

1478 Flash! Launch Set

Length: 16.2 in (41.2 cm)
Diameter: 1.1 in (28 mm)
Estimated Weight: 1.8 oz (52 g)
Recovery: 12 in (30.5 cm) Parachute
Projected Altitude: 925 ft (282 m)
Recommended Engines: A8-3 (First Flight), B4-4, B6-4, C6-5, C6-7

1491 Taser™ Launch Set

Length: 16.5 in (41.9 cm)
Diameter: .98 in (25 mm)
Estimated Weight: 1.5 oz (42.5 g)
Recovery: 12 in (30.5 cm) Parachute
Projected Altitude: 1,100 ft (335 m)
Recommended Engines: A8-3 (First Flight), B4-4, B6-4, B6-6,
C6-5, C6-7

SKILL LEVEL 2 LAUNCH SET

1466 Maxi Alpha™ 3 Launch Set

Skill Level: 2
Length: 33.25 in (84.5 cm)
Diameter: 2.6 in (66 mm)
Estimated Weight: 8 oz (226.8 g)
Fins: Plastic
Recovery: 24 in (61 cm) Parachute
Projected Altitude: 700 ft (213 m)
Recommended Engines: D12-3, E9-4*, E9-6*
Requires 3/16 in (5 mm) Maxi™ Launch Rod (2244), included.



Each Launch Set includes Estes Launch Pad and Controller
(Engines and alkaline batteries required – sold separately)

Estes model rocketry is recommended for ages 10 years and up.
Adult supervision is recommended for those under 12 years of age.

AIR-POWERED ROCKETS

1700 T-Bolt™ Air Party Pack Rocket Set
See page 86

1708 Rocket-Star™ Party Pack Rocket Set
See page 86

1900 T-Bolt™ Air Rocket Launch Set
Ready to fly
Length: 11.5 in (29.2 cm)
Estimated Weight: .87 oz (24.7 g)
Fins: Foam
Recovery: Bounce
Projected Altitude: 150 ft (46 m)

1908 Rocket-Star™ Rocket Launch Set
Rocket 1
Length: 8.8 in (22.4 cm)
Rocket 2
Length: 6.1 in (15.5 cm)
Fins: Foam
Recovery: Bounce
Projected Altitude: 50 ft (15.2 m)

1913 Volt™ and Zolt™ Air Rocket
Ready to fly
Length: 11.5 in (29.2 cm)
Estimated Weight: .87 oz (24.7 g)
Fins: Foam
Recovery: Bounce
Projected Altitude: 150 ft (46 m)

1915 Blast Jets™ Air Rocket
Ready to fly
Length: 11.5 in (29.2 cm)
Estimated Weight: .87 oz (24.7 g)
Fins: Foam
Recovery: Bounce / Glide
Projected Altitude: 150 ft (46 m)

1916 Whirlwind™ Air Rocket
Ready to fly
Length: 11.5 in (29.2 cm)
Estimated Weight: .87 oz (24.7 g)
Fins: Foam
Recovery: Helicopter / Bounce
Projected Altitude: 150 ft (46 m)



1900 T-Bolt™ Launch Set



1908 Rocket-Star™ Launch Set



NEW! 1913 Volt™



NEW! 1913 Zolt™

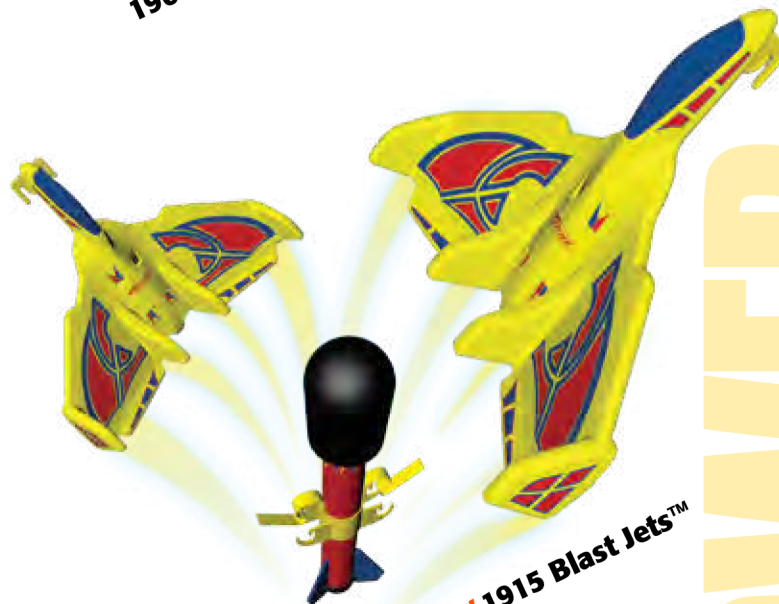

NEW! 1915 Blast Jets™



NEW! 1916 Whirlwind™

Estes model rocketry is recommended for ages 10 years and up. Adult supervision is recommended for those under 12 years of age.

READY TO FLY ROCKETS

1100 Pulsar Pink™

1101 Alien Green™

1102 Rocket Red™

1103 Planet Purple™

1104 Outer-space Orange™

1105 Blast-off Blue™

1106 Yellow Star™

1107 Black Hole™

1108 Galaxy Gold™

1109 Meteorite White™

1110 Atomic Aqua™

1111 Satellite Silver™

Length: 19.8 in (50.3 cm)

Diameter: 1.64 in (42 mm)

Estimated Weight: 2.8 oz (79.4 g)

Recovery: Parachute

Projected Altitude: 550 ft (168 m)

Recommended Engines: B4-2, B6-2 (First Flight), B6-4, C6-5

Note: The Color the Sky Bulk Pack rockets (1715) are E2X® (Easy to Assemble) and do require assembly.



1100 Pulsar Pink™



1101 Alien Green™



1102 Rocket Red™



1103 Planet Purple™



1104 Outer-space Orange™



1105 Blast-off Blue™



1106 Yellow Star™



1107 Black Hole™



1108 Galaxy Gold™



1109 Meteorite White™



1110 Atomic Aqua™



1111 Satellite Silver™

Estes model rocketry is recommended for ages 10 years and up. Adult supervision is recommended for those under 12 years of age.

READY TO FLY ROCKETS

1894 Sky Hawker™

Length: 16.5 in (41.9 cm)
Diameter: .98 in (25 mm)
Estimated Weight: 1.5 oz (42.5 g)
Recovery: 12 in (30.5 cm)
Projected Altitude: 1,125 ft (343 m)
Recommended Engines: A8-3 (First Flight), B4-4, B6-4, C6-5, C6-7

1895 Patriarch™

Length: 18 in (45.7 cm)
Diameter: 1.35 in (34 mm)
Estimated Weight: 2.7 oz (76.5 g)
Recovery: 12 in (30.5 cm) Parachute
Projected Altitude: 675 ft (206 m)
Recommended Engines: B4-4, B6-4 (First Flight), C6-5

1907 HiJinks™

Length: 14 in (35.6 cm)
Diameter: .98 in (25 mm)
Estimated Weight: 1.5 oz (43 g)
Recovery: 12 in (30.5 cm) Parachute
Projected Altitude: 1,200 ft (366 m)
Recommended Engines: A8-3 (First Flight), B4-4, B6-4, C6-5, C6-7

2450 EX-200™

Length: 14.25 in (36.2 cm)
Diameter: .74 in (19 mm)
Estimated Weight: .78 oz (22.1 g)
Recovery: 12 in (30.5 cm) Parachute
Projected Altitude: 550 ft (168 m)
Recommended Engines: 1/2A3-4T (First Flight), A3-4T, A10-3T



1894 Sky Hawker™

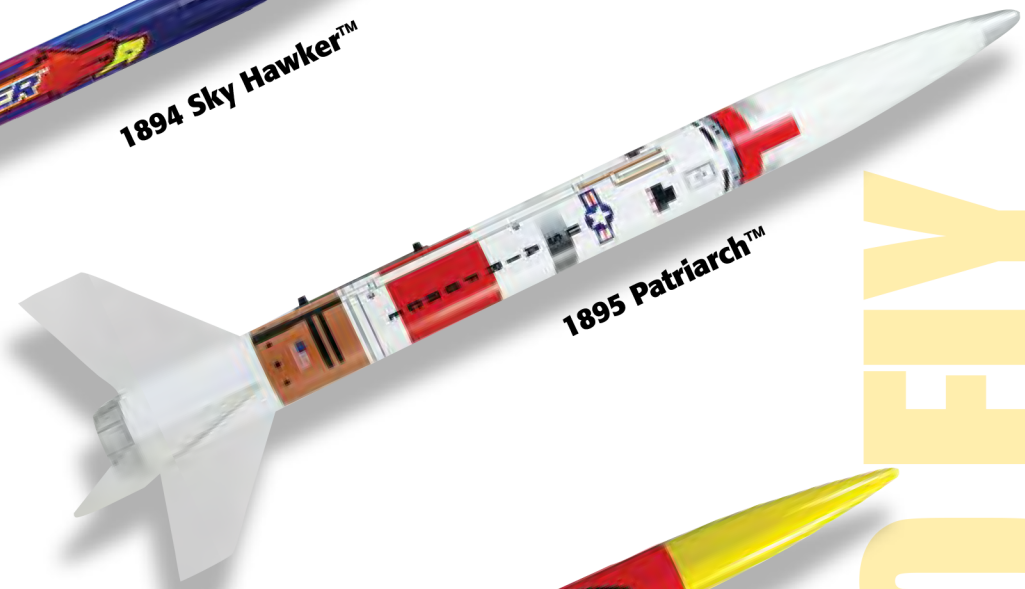

1895 Patriarch™



1907 HiJinks™



2450 EX-200™

READY TO FLY

Estes model rocketry is recommended for ages 10 years and up. Adult supervision is recommended for those under 12 years of age.

READY TO FLY ROCKETS

2451 Fuse™

Length: 13.1 in (33.3 cm)
Diameter: .74 in (19 mm)
Estimated Weight: .78 oz (22.1 g)
Recovery: 12 in (30.5 cm) Parachute
Projected Altitude: 550 ft (168 m)
Recommended Engines: 1/2A3-4T (First Flight),
A3-4T, A10-3T

2452 Athena™

Length: 16.5 in (41.9 cm)
Diameter: .98 in (25 mm)
Estimated Weight: 1.4 oz (39.7 g)
Recovery: 12 in (30.5 cm) Parachute
Projected Altitude: 1,125 ft (343 m)
Recommended Engines: A8-3
(First Flight), B6-4, C6-5

2454 SkyTrax™

Length: 20.75 in (52.7 cm)
Diameter: 1.35 in (34 mm)
Estimated Weight: 2.6 oz (73.7 g)
Recovery: 12 in (30.5 cm) Parachute
Projected Altitude: 675 ft (206 m)
Recommended Engines: B4-4, B6-4 (First Flight), C6-5

2455 Code Red™

Length: 18.75 in (47.6 cm)
Diameter: 1.35 in (34 mm)
Estimated Weight: 2.2 oz (62.4 g)
Recovery: 12 in (30.5 cm) Parachute
Projected Altitude: 725 ft (221 m)
Recommended Engines: B4-4, B6-4 (First Flight), C6-5

2457 Prospector™

Length: 23 in (58.4 cm)
Diameter: 1.35 in (34 mm)
Estimated Weight: 2.4 oz (68 g)
Recovery: 12 in (30.5 cm) Parachute
Projected Altitude: 700 ft (213 m)
Recommended Engines: B4-4,
B6-4 (First Flight), C6-5

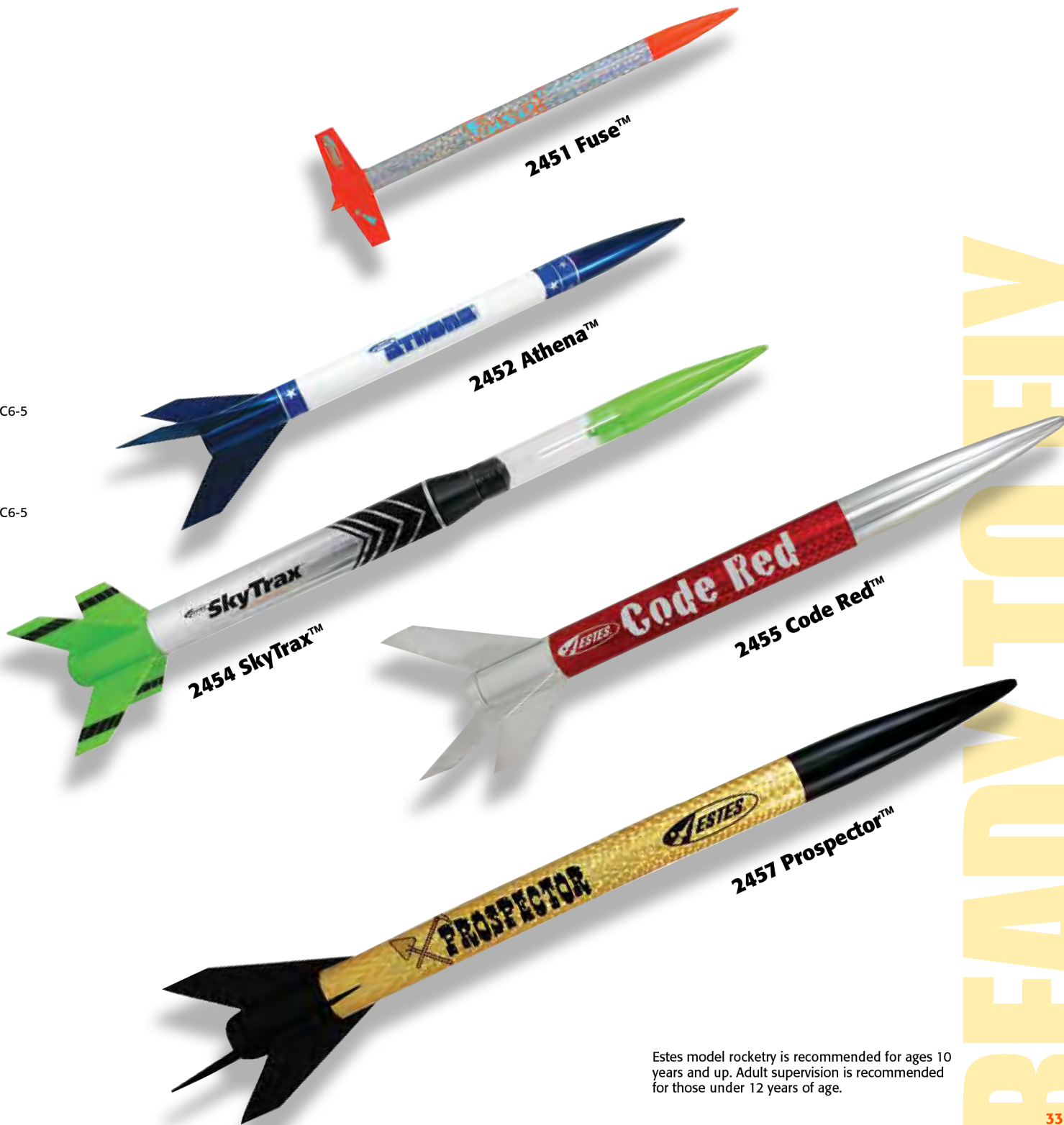

Estes model rocketry is recommended for ages 10 years and up. Adult supervision is recommended for those under 12 years of age.

READY TO FLY ROCKETS

2460 Fat Jax™

Length: 12.6 in (32 cm)
Diameter: .74 in (19 mm)
Estimated Weight: .72 oz (20.4 g)
Fins: Plastic
Recovery: 6 in (15.2 cm) Parachute
Projected Altitude: 425 ft (130 m)
Recommended Engines: 1/2A3-4T (First Flight), A3-4T, A10-3T

2461 Nitro™

Length: 12.6 in (32 cm)
Diameter: .74 in (19 mm)
Estimated Weight: .69 oz (19.6 g)
Fins: Plastic
Recovery: 6 in (15.2 cm) Parachute
Projected Altitude: 425 ft (130 m)
Recommended Engines: 1/2A3-4T (First Flight), A3-4T, A10-3T

2462 Sky Duster™

Length: 12.9 in (32.8 cm)
Diameter: .74 in (19 mm)
Estimated Weight: .74 oz (21 g)
Fins: Plastic
Recovery: 6 in (15.2 cm) Parachute
Projected Altitude: 425 ft (130 m)
Recommended Engines: 1/2A3-4T (First Flight), A3-4T, A10-3T

2472 Sizzler™

Length: 14.5 in (36.8 cm)
Diameter: 1.64 in (42 mm)
Estimated Weight: 2.1 oz (59.5 g)
Recovery: Parachute
Projected Altitude: 550 ft (168 m)
Recommended Engines: B4-4, B6-4 (First Flight), C6-5

2474 Outlaw™

Length: 22 in (55.9 cm)
Diameter: 1.35 in (34 mm)
Estimated Weight: 2 oz (56.7 g)
Recovery: Parachute
Projected Altitude: 750 ft (229 m)
Recommended Engines: B4-4, B6-4 (First Flight), C6-5

2475 Longneck Express™

Length: 23.25 in (59.1 cm)
Diameter: .98 in (25 mm)
Estimated Weight: 1.4 oz (39.7 g)
Recovery: Parachute
Projected Altitude: 1125 ft (343 m)
Recommended Engines: A8-3 (First Flight), B4-4, B6-4, C6-5



Estes model rocketry is recommended for ages 10 years and up. Adult supervision is recommended for those under 12 years of age.

ALMOST READY TO FLY ROCKETS

2473 Shooting Star™

Length: 19.25 in (48.9 cm)
Diameter: 1.35 in (34 mm)
Estimated Weight: 2.3 oz (65.2 g)
Recovery: Parachute
Projected Altitude: 725 ft (221 m)
Recommended Engines: B4-4, B6-4 (First Flight), C6-5



2473 Shooting Star™

2481 Power Patrol™

Length: 20.5 in (52.1 cm)
Diameter: .98 in (25 mm)
Estimated Weight: 1.6 oz (45.4 g)
Recovery: Parachute
Projected Altitude: 1100 ft (335 m)
Recommended Engines: A8-3 (First Flight), B4-4, B6-4, C6-5, C6-7



2481 Power Patrol™

2482 Solaris™

Length: 18.5 in (47 cm)
Diameter: .98 in (25 mm)
Estimated Weight: 1.6 oz (45.4 g)
Recovery: Parachute
Projected Altitude: 1125 ft (343 m)
Recommended Engines: A8-3 (First Flight), B4-4, B6-4, C6-5, C6-7

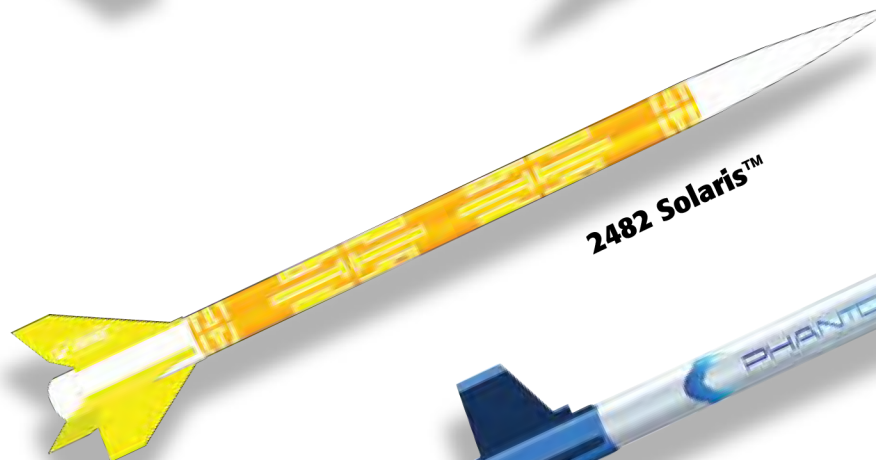

2482 Solaris™

2483 Phantom Blue™

Length: 19.3 in (49 cm)
Diameter: .98 in (25 mm)
Estimated Weight: 1.4 oz (39.7 g)
Recovery: Parachute
Projected Altitude: 1150 ft (351 m)
Recommended Engines: A8-3 (First Flight), B4-4, B6-4, C6-5, C6-7



2483 Phantom Blue™

2485 L.G.M. 0095™

Length: 21 in (53.3 cm)
Diameter: 1.33 in (34 mm)
Estimated Weight: 2.7 oz (79.5 g)
Recovery: Parachute
Projected Altitude: 650 ft (198 m)
Recommended Engines: B4-2 (First Flight), B6-2, B6-4, C6-3, C6-5



2485 L.G.M. 0095™

Estes model rocketry is recommended for ages 10 years and up. Adult supervision is recommended for those under 12 years of age.

ALMOST READY TO FLY

ALMOST READY TO FLY ROCKETS

2486 Flying Colors™

Length: 21 in (53.3 cm)
 Diameter: 1.64 in (42 mm)
 Estimated Weight: 3 oz (85 g)
 Recovery: Parachute
 Projected Altitude: 600 ft (183 m)
 Recommended Engines: B4-2 (First Flight), B6-2, B6-4, C6-3, C6-5



2488 Firestorm™

Length: 20.8 in (52.8 cm)
 Diameter: 1.64 in (42 mm)
 Estimated Weight: 3 oz (85 g)
 Recovery: Parachute
 Projected Altitude: 600 ft (183 m)
 Recommended Engines: B4-2 (First Flight), B6-2, B6-4, C6-3, C6-5



2884 Red Rider™

Length: 18.5 in (47 cm)
 Diameter: 1.33 in (34 mm)
 Estimated Weight: 3 oz (85 g)
 Recovery: Parachute
 Projected Altitude: 700 ft (213 m)
 Recommended Engines: B4-2 (First Flight), B6-2, B6-4, C6-3, C6-5



2887 Helios™

Length: 18.2 in (46.2 cm)
 Diameter: 1.64 in (42 mm)
 Estimated Weight: 3.7 oz (104.9 g)
 Recovery: Parachute
 Projected Altitude: 600 ft (183 m)
 Recommended Engines: B4-2 (First Flight), B6-2, B6-4, C6-3, C6-5



INCREASE YOUR ALTITUDE BY 800 FEET!

2256 Booster-60

For use with rockets 2486 Flying Colors™, 2887 Helios™, 2488 Firestorm™, 2490 Fractured™, 2493 Spectra™.
 Recommended Engine: D12-0



2257 Booster-55

For use with rockets 2884 Red Rider™ and 2485 L.G.M. 0095™, 2491 Drifter™, 2492 Spirit™, 2495 Chiller™.
 Recommended Engine: D12-0



2258 Booster-60 Stager Replacement

For use with 2257 Booster-60

2259 Booster-55 Stager Replacement

For use with 2256 Booster-55



Estes model rocketry is recommended for ages 10 years and up. Adult supervision is recommended for those under 12 years of age.

ALMOST READY TO FLY

ALMOST READY TO FLY ROCKETS

2489 Hyper Dart™

Length: 16.1 in (40.9 cm)
 Diameter: .98 in (25 mm)
 Estimated Weight: 1.4 oz (39.7 g)
 Recovery: Parachute
 Projected Altitude: 1125 ft (343 m)
 Recommended Engines: A8-3 (First Flight), B4-4, B6-4, C6-5, C6-7



2489 Hyper Dart™

2490 Fractured™

Length: 18 in (45.7 cm)
 Diameter: 1.64 in (42 mm)
 Estimated Weight: 3.7 oz (104.9 g)
 Recovery: Parachute
 Projected Altitude: 550 ft (168 m)
 Recommended Engines: B4-2, B6-2 (First Flight), B6-4, C6-3, C6-5



2490 Fractured™

2491 Drifter™

Length: 18.6 in (47.2 cm)
 Diameter: 1.33 in (34 mm)
 Estimated Weight: 2.1 oz (59.5 g)
 Recovery: Parachute
 Projected Altitude: 700 ft (213 m)
 Recommended Engines: B4-2, B6-2, B6-4 (First Flight), C6-3, C6-5



2491 Drifter™

2492 Spirit™

Length: 20 in (50.8 cm)
 Diameter: 1.33 in (34 mm)
 Estimated Weight: 2.6 oz (73.7 g)
 Recovery: Parachute
 Projected Altitude: 700 ft (213 m)
 Recommended Engines: B4-2, B6-2, B6-4 (First Flight), C6-3, C6-5

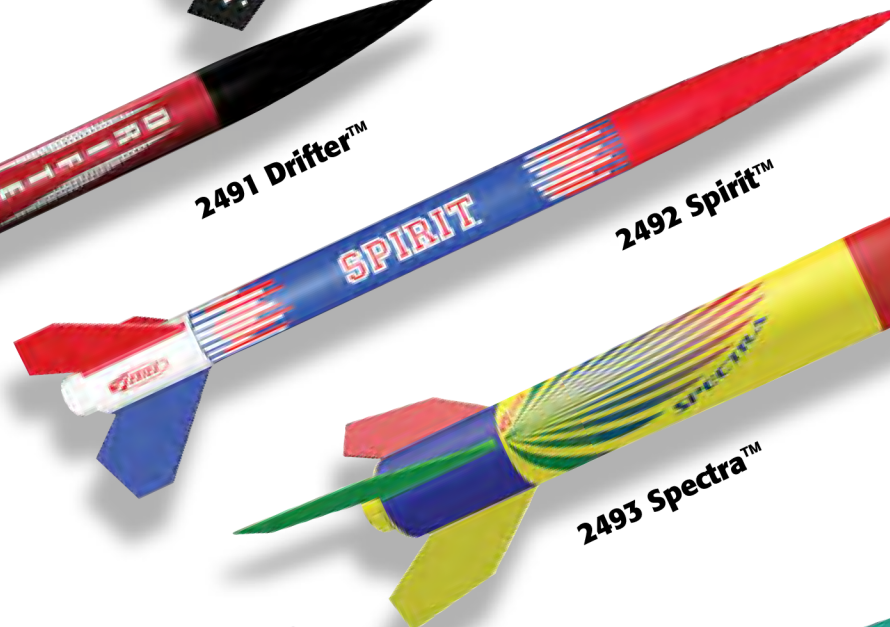

2492 Spirit™

2493 Spectra™

Length: 16.6 in (42.2 cm)
 Diameter: 1.64 in (42 mm)
 Estimated Weight: 3.5 oz (99.2 g)
 Recovery: Parachute
 Projected Altitude: 550 ft (168 m)
 Recommended Engines: B4-2, B6-2, B6-4 (First Flight), C6-3, C6-5

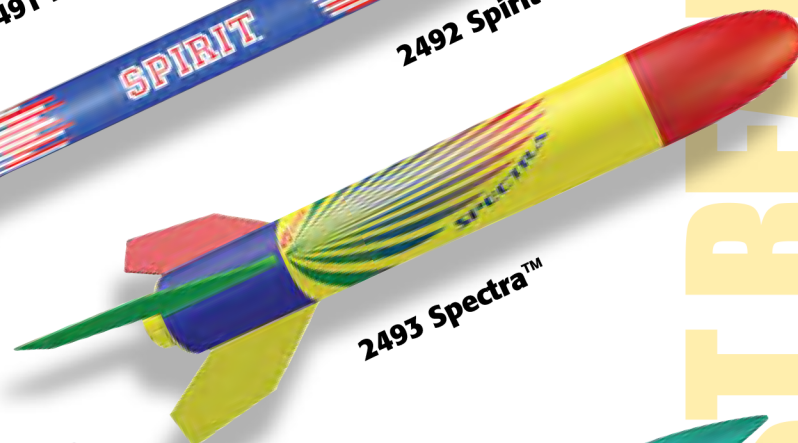

2493 Spectra™

2494 Dazzler™

Length: 17.5 in (44.5 cm)
 Diameter: .98 in (25 mm)
 Estimated Weight: 1.5 oz (30.5 g)
 Recovery: Parachute
 Projected Altitude: 1125 ft (343 m)
 Recommended Engines: A8-3 (First Flight), B4-4, B6-4, C6-5, C6-7



2494 Dazzler™

2495 Chiller™

Length: 17.3 in (43.9 cm)
 Diameter: 1.33 in (34 mm)
 Estimated Weight: 2.2 oz (62.4 g)
 Recovery: Parachute
 Projected Altitude: 600 ft (183 m)
 Recommended Engines: B4-2 (First Flight), B6-2, B6-4, C6-3, C6-5



2495 Chiller™

Estes model rocketry is recommended for ages 10 years and up. Adult supervision is recommended for those under 12 years of age.

E2X® (EASY TO ASSEMBLE) ROCKET KITS

0803 Bandito™

Length: 11.2 in (28.4 cm)
Diameter: .74 in (19 mm)
Estimated Weight: .60 oz (17 g)
Fins: Plastic
Recovery: 12 in (30.5 cm) Parachute
Projected Altitude: 600 ft (183 m)
Recommended Engines: 1/4A3-3T (First Flight),
1/2A3-2T, A3-4T, A10-3T

0804 Firehawk™

Length: 11.2 in (28.4 cm)
Diameter: .74 in (19 mm)
Estimated Weight: .65 oz (18.4 g)
Fins: Plastic
Recovery: 12 in (30.5 cm) Parachute
Projected Altitude: 550 ft (168 m)
Recommended Engines: 1/4A3-3T (First Flight),
1/2A3-2T, A3-4T, A10-3T

0806 Firestreak SST™

Length: 10.2 in (25.9 cm)
Diameter: .86 in (22 mm)
Estimated Weight: 1.1 oz (31.2 g)
Fins: Plastic
Recovery: Streamer
Projected Altitude: 350 ft (107 m)
Recommended Engines: 1/2A3-2T,
A3-4T (First Flight), A10-3T

1256 Alpha III®

Length: 12.3 in (31.2 cm)
Diameter: .98 in (25 mm)
Estimated Weight: 1.2 oz (34 g)
Fins: Plastic
Recovery: 12 in (30.5 cm) Parachute
Projected Altitude: 1,100 ft (335 m)
Recommended Engines: 1/2A6-2, A8-3 (First Flight),
B4-4, B6-4, B6-6, C6-5, C6-7

1260 No. 2 Estes Sky Writer®

Length: 26 in (66 cm)
Diameter: .98 in (25 mm)
Estimated Weight: 1.7 oz (48.2 g)
Fins: Plastic
Recovery: 12 in (30.5 cm) Parachute
Projected Altitude: 1,100 ft (335 m)
Recommended Engines: A8-3 (First Flight), B4-4,
B6-4, C6-5



0803 Bandito™



0804 Firehawk™



0806 Firestreak SST™



1256 Alpha III®

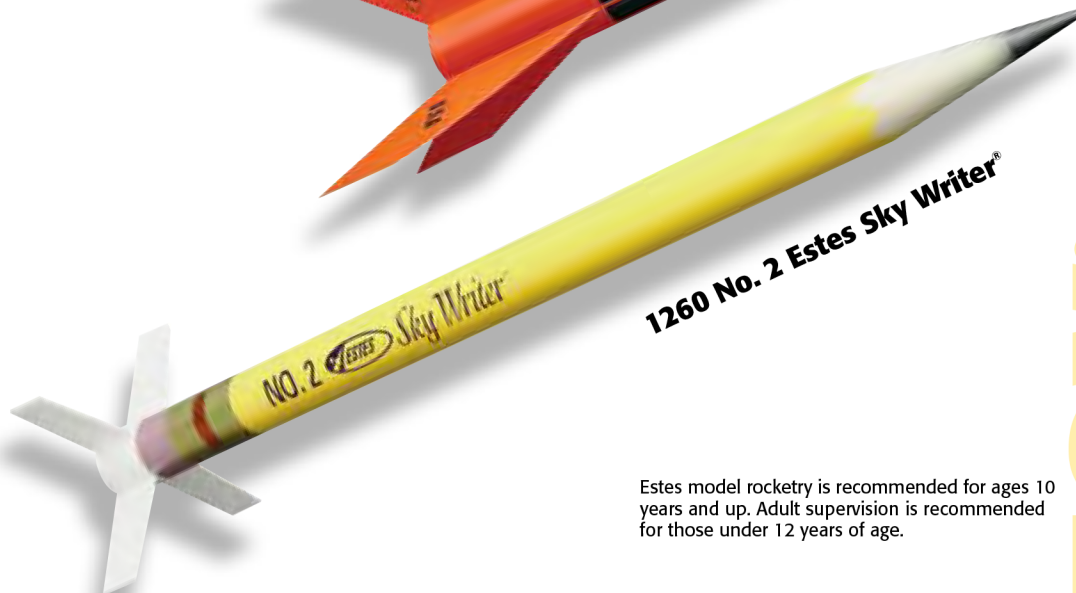

1260 No. 2 Estes Sky Writer®

Estes model rocketry is recommended for ages 10 years and up. Adult supervision is recommended for those under 12 years of age.

E2X® (EASY TO ASSEMBLE) ROCKET KITS

1263 Sky Twister™

Length: 21.3 in (54.1 cm)
 Diameter: 1.35 in (34 mm)
 Estimated Weight: 2.9 oz (82.2 g)
 Fins: Plastic
 Recovery: 12 in (30.5 cm) Parachute and helicopter nose cone
 Projected Altitude: 650 ft (198 m)
 Recommended Engines: B6-2, B6-4 (First Flight), C6-3, C6-5

1330 Freefall™

Length: 20.5 in (52.1 cm)
 Diameter: 1.64 in (42 mm)
 Estimated Weight: 2.5 oz (71 g)
 Fins: Plastic
 Recovery: 12 in (30.5 cm) Parachute
 Projected Altitude: 575 ft (175 m)
 Recommended Engines: B4-2 (First Flight), B6-2, B6-4, C6-3, C6-5

1954 Red Flare™

Length: 24.4 in (62 cm)
 Diameter: 2.6 in (6.6 cm)
 Estimated Weight: 6.5 oz (184.3 g)
 Recovery: Parachute
 Projected Altitude: 1000 ft (305 m)
 Recommended Engines: D12-5 (First Flight), E9-4*, E9-6*
 Requires 3/16 in (5 mm) Maxi™ launch rod (2244), sold separately.

1955 Top Shot™

Length: 37 in (94 cm)
 Diameter: 1.64 in (42 mm)
 Estimated Weight: 5.3 oz (150 g)
 Recovery: Parachute
 Projected Altitude: 1150 ft (351 m)
 Recommended Engines: D12-5 (First Flight), E9-6*, E12-6*
 Requires 3/16 in (5 mm) Maxi™ launch rod (2244), sold separately.



* E engines require the E™ Launch Controller (2230), sold separately.

Estes model rocketry is recommended for ages 10 years and up. Adult supervision is recommended for those under 12 years of age.

E2X® (EASY TO ASSEMBLE) ROCKET KITS

1956 Firebolt™

Length: 36.5 in (92.7 cm)
 Diameter: 1.64 in (42 mm)
 Estimated Weight: 6.8 oz (192.8 g)
 Recovery: Parachute
 Projected Altitude: 1000 ft (305 m)
 Recommended Engines: D12-5 (First Flight), E9-6, D12-6*
 Requires 3/16 in (5 mm) Maxi™ launch rod (2244), sold separately.



1956 Firebolt™

2132 Banshee™

Length: 15.6 in (39.6 cm)
 Diameter: 1.1 in (28 mm)
 Estimated Weight: 1.9 oz (53.9 g)
 Recovery: Parachute
 Projected Altitude: 1100 ft (335 m)
 Recommended Engines: A8-3 (First Flight), B4-4, B6-4, B6-6, C6-5, C6-7



2132 Banshee™

2158 AGM-57X Heatseeker™

Length: 18.6 in (47.2 cm)
 Diameter: 1.1 in (28 mm)
 Estimated Weight: 2.3 oz (65.2 g)
 Recovery: Parachute
 Projected Altitude: 875 ft (267 m)
 Recommended Engines: B4-4 (First Flight), B6-4, C6-5



2158 AGM-57X Heatseeker™

2168 Metalizer™

Length: 22.5 in (57.2 cm)
 Diameter: 1.35 in (34 mm)
 Estimated Weight: 2.4 oz (68 g)
 Fins: Plastic
 Recovery: 12 in (30.5 cm) Parachute
 Projected Altitude: 760 ft (232 m)
 Recommended Engines: B4-4 (First Flight), B6-4, C6-5



2168 Metalizer™

2169 Dragonite™

Length: 16 in (40.6 cm)
 Diameter: 1.1 in (28 mm)
 Estimated Weight: 1.8 oz (51 g)
 Fins: Plastic
 Recovery: 12 in (30.5 cm) Parachute
 Projected Altitude: 1,125 ft (343 m)
 Recommended Engines: A8-3 (First Flight), B4-4, B6-4, C6-5, C6-7



2169 Dragonite™

* E engines require the E™ Launch Controller (2230), sold separately.

Estes model rocketry is recommended for ages 10 years and up. Adult supervision is recommended for those under 12 years of age.

E2X® (EASY TO ASSEMBLE) ROCKET KITS

2183 Shuttle Xpress™

Length: 17.7 in (45 cm)
 Diameter: 1.33 in (34 mm)
 Estimated Weight: 3.2 oz (90.7 g)
 Fins: Plastic
 Recovery: Booster - 12 in (30.5 cm) Parachute;
 Shuttles - Glide
 Projected Altitude: 600 ft (183 m)
 Recommended Engines: B4-2 (First Flight), B4-4, B6-2,
 B6-4, C6-3, C6-5



2183 Shuttle Xpress™

2428 Orange Crush™

Length: 32.7 in (83.1 cm)
 Diameter: 1.35 in (34 mm)
 Estimated Weight: 2.3 oz (65.2 g)
 Recovery: Parachute
 Projected Altitude: 850 ft (259 m)
 Recommended Engines: C11-3 (First Flight), D12-3, D12-5



2428 Orange Crush™

2429 Humdinger™

Length: 22.5 in (57.2 cm)
 Diameter: .54 in (14 mm)
 Estimated Weight: .65 oz (18.4 g)
 Recovery: Parachute
 Projected Altitude: 1000 ft (335 m)
 Recommended Engines: 1/2A3-2T (First Flight), 1/2A3-4T,
 A3-4T, A10-3T



2429 Humdinger™

2431 Dink™

Length: 10 in (25.4 cm)
 Diameter: .74 in (19 mm)
 Estimated Weight: .6 oz (15.2 g)
 Recovery: Parachute
 Projected Altitude: 600 ft (183 m)
 Recommended Engines: 1/2A3-4T (First Flight),
 A3-4T, A10-3T



2431 Dink™

2432 Mix-it Up™

Length: 16.25 in (41.3 cm)
 Diameter: .98 in (25 mm)
 Estimated Weight: 1.4 oz (39.7 g)
 Recovery: Parachute
 Projected Altitude: 1100 ft (335 m)
 Recommended Engines: A8-3 (First Flight),
 B4-4, B6-4, B6-6, C6-5, C6-7



2432 Mix-it Up™

Estes model rocketry is recommended for ages 10 years and up. Adult supervision is recommended for those under 12 years of age.



E2X® (EASY TO ASSEMBLE) ROCKET KITS

2433 Zinger™

Length: 15 in (38.1 cm)
Diameter: .74 in (19 mm)
Estimated Weight: .9 oz (25.5 g)
Fins: Plastic
Recovery: 12 in (30.5 cm) Parachute
Projected Altitude: 500 ft (152 m)
Recommended Engines: 1/2A3-4T (First Flight), A3-4T, A10-3T

2434 Silver Streak™

Length: 10 in (25.4 cm)
Diameter: .74 in (19 mm)
Estimated Weight: .65 oz (18.4 g)
Fins: Plastic
Recovery: 6 in (15.2 cm) Parachute
Projected Altitude: 575 ft (176 m)
Recommended Engines: 1/2A3-4T (First Flight), A3-4T, A10-3T

2437 Savage™

Length: 31.8 in (80.6 cm)
Diameter: 1.33 in 34 mm
Estimated Weight: 4.7 oz (133.2 g)
Recovery: Parachute
Projected Altitude: 1600 ft (488 m)
Recommended Engines:
Single Stage: B4-2, B6-2, B6-4 (First Flight), C6-5
Booster: D12-0
With Booster: A8-5, B6-4 (First Flight) B6-6, C6-5, C6-7

2439 Shattered™

Length: 34 in (86.4 cm)
Diameter: .98 in (25 mm)
Estimated Weight: 2.5 oz (70.9 g)
Recovery: Parachute
Projected Altitude: 925 ft (282 m)
Recommended Engines: B6-4 (First Flight), C6-5

2435 3 Bandits™

3 rocket set
Length: 10.8-11.1 in (27.4-28.3 cm)
Diameter: .74 in (19 mm)
Estimated Weight: .6-.71 oz (19.8-20.1 g)
Recovery: Parachute
Projected Altitude: 550 ft (168 m)
Recommended Engines: 1/2A3-4T (First Flight), A3-4T, A10-3T



Estes model rocketry is recommended for ages 10 years and up. Adult supervision is recommended for those under 12 years of age.

E2X® (EASY TO ASSEMBLE) ROCKET KITS

2436 Emerald Streak™

Length: 22 in (55.9 cm)
Diameter: 1.1 in (28 mm)
Estimated Weight: 2.0 oz (56.7 g)
Recovery: Parachute
Projected Altitude: 950 ft (290 m)
Recommended Engines: B4-4 (First Flight), B6-4, C6-5

2438 Sky Shark™

Length: 15.1 in (38.4 cm)
Diameter: .74 in (19 mm)
Estimated Weight: .76 oz (21.5 g)
Recovery: Parachute
Projected Altitude: 550 ft (168 m)
Recommended Engines: 1/2A3-2T (First Flight),
1/2A3-4T, A3-4T, A10-3T

2443 Splendor™

Length: 24.8 in (63 cm)
Diameter: 1.35 in (34 mm)
Estimated Weight: 2.6 oz (73.7 g)
Recovery: Parachute
Projected Altitude: 700 ft (213 m)
Recommended Engines: B6-4 (First Flight), C6-5

2463 Dark Zero™

Length: 21.3 in (54.1 cm)
Diameter: 1.1 in (28 mm)
Estimated Weight: 2.1 oz (59.5 g)
Recovery: Parachute
Projected Altitude: 975 ft (297 m)
Recommended Engines: B4-4, B6-4 (First Flight), C6-5

2476 Black Diamond™

Length: 26.25 in (66.7 cm)
Diameter: 1.64 in (42 mm)
Estimated Weight: 3.3 oz (93.6 g)
Recovery: Parachute
Projected Altitude: 500 ft (152 m)
Recommended Engines: B4-2 (First Flight), B6-2, C6-3



Estes model rocketry is recommended for ages 10 years and up. Adult supervision is recommended for those under 12 years of age.

SKILL LEVEL 1 ROCKET KITS

0651 Der Red Max™

Length: 16.3 in (41.4 cm)
Diameter: 1.64 in (42 mm)
Estimated Weight: 2.4 oz (68 g)
Fins: Laser cut wood
Recovery: 18 in (46 cm) Parachute
Projected Altitude: 600 ft (183 m)
Recommended Engines: B4-2, B4-4, B6-2 (First Flight), B6-4, C6-5

0810 220 Swift™

Length: 4.5 in (11.4 cm)
Diameter: .54 in (14 mm)
Estimated Weight: .09 oz (2.5 g)
Fins: Laser cut wood
Recovery: Tumble
Projected Altitude: 850 ft (259 m)
Recommended Engines: 1/4A3-3T (First Flight), 1/2A3-2T, 1/2A3-4T, A3-4T, A10-3T

1225 Alpha®

Length: 12.3 in (31.2 cm)
Diameter: .98 in (25 mm)
Estimated Weight: .8 oz (23 g)
Fins: Laser cut wood
Recovery: 12 in (30.5 cm) Parachute
Projected Altitude: 1,000 ft (305 m)
Recommended Engines: 1/2A6-2, A8-3 (First Flight), A8-5, B4-4, B6-4, B6-6, C6-5, C6-7

1261 Baby Bertha™

Length: 12.8 in (32.5 cm)
Diameter: 1.64 in (42 mm)
Estimated Weight: 1.9 oz (53.9 g)
Fins: Laser cut wood
Recovery: 12 in (30.5 cm) Parachute
Projected Altitude: 575 ft (175 m)
Recommended Engines: A8-3 (First Flight), B4-4, B6-4, C6-5

1292 Wizard™

Length: 12 in (30.5 cm)
Diameter: .74 in (19 mm)
Estimated Weight: .5 oz (14.2 g)
Fins: Laser cut wood
Recovery: Streamer
Projected Altitude: 1,600 ft (488 m)
Recommended Engines: 1/2A6-2, A8-3 (First Flight), A8-5, B4-4, B6-4, B6-6, C6-5, C6-7



0651 Der Red Max™



0810 220 Swift™



1225 Alpha®



1261 Baby Bertha™



1292 Wizard™

Estes model rocketry is recommended for ages 10 years and up. Adult supervision is recommended for those under 12 years of age.

SKILL LEVEL 1 ROCKET KITS

1345 Mosquito™

Length: 3.8 in (9.6 cm)
 Diameter: .54 in (14 mm)
 Estimated Weight: .11 oz (3.1 g)
 Fins: Laser cut wood
 Recovery: Tumble
 Projected Altitude: 800 ft (244 m)
 Recommended Engines: 1/4A3-3T (First Flight), 1/2A3-2T, 1/2A3-4T, A3-4T, A10-3T



1381 Yankee™

Length: 11 in (27.9 cm)
 Diameter: .74 in (19 mm)
 Estimated Weight: .4 oz (12 g)
 Fins: Laser cut wood
 Recovery: Streamer
 Projected Altitude: 1,850 ft (564 m)
 Recommended Engines: 1/2A6-2, A8-3 (First Flight), A8-5, B4-4, B6-4, B6-6, C6-5, C6-7



1948 Big Bertha™

Length: 24 in (61 cm)
 Diameter: 1.64 in (42 mm)
 Estimated Weight: 2.5 oz (71 g)
 Fins: Laser cut wood
 Recovery: 18 in (46 cm) parachute
 Projected Altitude: 500 ft (152 m)
 Recommended Engines: B4-2, B4-4, B6-2, B6-4 (First Flight), C6-5



1949 Viking™

Length: 12.1 in (30.7 cm)
 Diameter: .74 in (19 mm)
 Estimated Weight: .6 oz (17 g)
 Fins: Card stock
 Recovery: Streamer
 Projected Altitude: 1,600 ft (488 m)
 Recommended Engines: 1/2A6-2, A8-3 (First Flight), A8-5, B4-4, B6-4, B6-6, C6-5, C6-7



2056 U.S. Army Patriot M-104

Length: 21.3 in (54.1 cm)
 Diameter: 1.64 in (42 mm)
 Estimated Weight: 2 oz (56.7 g)
 Fins: Laser cut wood
 Recovery: 12 in (30.5 cm) Parachute
 Projected Altitude: 600 ft (183 m)
 Recommended Engines: B4-4 (First Flight), B6-4, C6-5



2092 Mongoose™

All pre-colored parts
 Length: 26.5 in (67.3 cm)
 Diameter: .98 in (25 mm)
 Estimated Weight: 2.3 oz (65 g)
 Fins: Plastic
 Recovery: 12 in (30.5 cm) Parachute and Tumble
 Projected Altitude: 1,600 ft (488 m)
 Recommended Engines:
 Single Stage: A8-3 (First Flight), B4-4, B6-4, C6-5;
 Two Stage: Booster – B6-0 (First Flight), C6-0;
 Upper Stage: A8-5 (First Flight), B6-6, C6-7



Estes model rocketry is recommended for ages 10 years and up. Adult supervision is recommended for those under 12 years of age.

SKILL LEVEL 1 ROCKET KITS

2178 Hi-Flier®

Length: 12 in (30.5 cm)
 Diameter: .74 in (19 mm)
 Estimated Weight: .9 oz (25.5 g)
 Fins: Laser cut wood
 Recovery: Streamer
 Projected Altitude: 1,500 ft (457 m)
 Recommended Engines: 1/2A6-2, A8-3 (First Flight),
 A8-5, B4-4, B6-4, B6-6, C6-5, C6-7



2178 Hi-Flier®

2421 Cosmic Explorer™

Length: 24 in (61 cm)
 Diameter: 1.33 in (34 mm)
 Estimated Weight: 2.8 oz (78 g)
 Fins: Laser cut wood
 Recovery: 18 in (46 cm) Parachute
 Projected Altitude: 650 ft (198 m)
 Recommended Engines: B4-4 (First Flight), B6-4, C6-5



2421 Cosmic Explorer™

2442 Mini Fat Boy™

Length: 8.5 in (21.6 cm)
 Diameter: 1.64 in (42 mm)
 Estimated Weight: 1.3 oz (36.8 g)
 Fins: Laser cut wood
 Recovery: Parachute
 Projected Altitude: 250 ft (76 m)
 Recommended Engines: A10-3T



2442 Mini Fat Boy™

2444 Fletcher™

Length: 39.25 in (99.7 cm)
 Diameter: .74 in (19 mm)
 Estimated Weight: 1.4 oz (39.7 g)
 Fins: Laser cut wood
 Recovery: 6 in (15.2 cm) Parachute
 Projected Altitude: 325 ft (99 m)
 Recommended Engines: A3-4T (First Flight), A10-3T



2444 Fletcher™

2445 Mini Max™

Length: 8.8 in (22.4 cm)
 Diameter: .98 in (25 mm)
 Estimated Weight: 1.3 oz (37 g)
 Fins: Laser cut wood
 Recovery: Streamer
 Projected Altitude: 300 ft (91.5 m)
 Recommended Engines: 1/2A3-2T (First Flight),
 1/2A3-4T, A3-4T, A10-3T



2445 Mini Max™

2446 Mini Honest John

Length: 11.75 in (29.8 cm)
 Diameter: .98 in (25 mm)
 Estimated Weight: 1.2 oz (34 g)
 Fins: Laser cut wood
 Recovery: 12 in (30.5 cm) Parachute
 Projected Altitude: 325 ft (99 m)
 Recommended Engines: 1/2A3-2T (First Flight),
 A3-4T, A10-3T



2446 Mini Honest John

Estes model rocketry is recommended for ages 10 years and up. Adult supervision is recommended for those under 12 years of age.

SKILL LEVEL 1 ROCKET KITS

3009 Chuter-Two™

Length: 18.5 in (47 cm)
 Diameter: .98 in (25 mm)
 Estimated Weight: 1.2 oz (34 g)
 Fins: Laser cut wood
 Recovery: 2 1/2 in (30.5 cm) Parachutes
 Projected Altitude: 900 ft (274 m)
 Recommended Engines: A8-3 (First Flight), B6-4, C6-5



3009 Chuter-Two™

3013 Flutter-By™

Length: 8.25 in (21 cm)
 Diameter: .98 in (25 mm)
 Estimated Weight: 1.4 oz (39.7 g)
 Fins: Laser cut wood
 Recovery: Tumble
 Projected Altitude: 575 ft (175 m)
 Recommended Engines: 1/2A6-2, A8-3 (First Flight), B4-2, B4-4, B6-2, B6-4



3013 Flutter-By™

3024 Phoenix Bird™

Length: 24 in (61 cm)
 Diameter: 1.33 in (34 mm)
 Estimated Weight: 2.8 oz (79 g)
 Fins: Laser cut wood
 Recovery: 18 in (46 cm) Parachute
 Projected Altitude: 550 ft (168 m)
 Recommended Engines: B4-4 (First Flight), B6-4, C6-5



3024 Phoenix Bird™

3031 Star Trooper™

Length: 7 in (17.8 cm)
 Diameter: .54 in (14 mm)
 Estimated Weight: .3 oz (8.5 g)
 Fins: Laser cut wood
 Recovery: Streamer
 Projected Altitude: 900 ft (274 m)
 Recommended Engines: 1/4A3-3T, 1/2A3-4T, A3-4T (First Flight), A10-3T



3031 Star Trooper™

3037 Hornet

Length: 19.25 in (48.9 cm)
 Diameter: 1.33 in (34 mm)
 Estimated Weight: 2.3 oz (65 g)
 Fins: Laser cut wood
 Recovery: 12 in (30.5 cm) Parachute
 Projected Altitude: 775 ft (236 m)
 Recommended Engines: B4-4 (First Flight), B6-4, C6-5



3037 Hornet

3201 Taser Twin™

Length: 15.4 in (39 cm)
 Diameter: .74 in (19 mm)
 Estimated Weight: 1.8 oz (51 g)
 Fins: Laser cut wood
 Recovery: Tumble/Streamer
 Projected Altitude: 2,000 ft (610 m)
 Recommended Engines:
 Upper and Single Stage: A8-5 (First Flight), B6-6, C6-5, C6-7
 Booster: A8-0 (First Flight), B6-0, C6-0



3201 Taser Twin™

Estes model rocketry is recommended for ages 10 years and up. Adult supervision is recommended for those under 12 years of age.

SKILL LEVEL 1

SKILL LEVEL 1 ROCKET KITS

3230 Estes Jetliner™

Length: 9.3 in (23.6 cm)
Diameter: 1.64 in (42 mm)
Wingspan: 11 in (27.9 cm)
Estimated Weight: 1.9 oz (53.9 g)
Fins: Laser cut wood
Recovery: Parachute
Projected Altitude: 150 ft (46 m)
Recommended Engines: A10-3T



3231 Curvilinear™

Length: 10.5 in (27.7 cm)
Diameter: 1.64 in (42 mm)
Estimated Weight: 1.5 oz (42.5 g)
Fins: Laser cut wood
Recovery: Parachute
Projected Altitude: 175 ft (53 m)
Recommended Engines: A10-3T



7214 Monarch™

Length: 22.5 in (57.1 cm)
Diameter: 1.33 in (34 mm)
Estimated Weight: 2.4 oz (68 g)
Fins: Laser cut wood
Recovery: 18 in (46 cm) Parachute
Projected Altitude: 700 ft (228 m)
Recommended Engines: B6-4 (First Flight), C6-5



7215 Stratocruiser™

Length: 23.5 in (59.7 cm)
Diameter: 1.33 in (34 mm)
Estimated Weight: 2.2 oz (62.4 g)
Fins: Laser cut wood
Recovery: 12 in (30.5 cm) Parachute
Projected Altitude: 725 ft (221 m)
Recommended Engines: B6-4 (First Flight), C6-5



7220 Crossfire ISX™

Length: 15.6 in (39.6 cm)
Diameter: .98 in (25 mm)
Estimated Weight: 1.3 oz (37 g)
Fins: Laser cut wood
Recovery: 12 in (30.5 cm) Parachute
Projected Altitude: 1150 ft (351 m)
Recommended Engines: A8-3 (First Flight), B4-4, B6-4, C6-5, C6-7



Estes model rocketry is recommended for ages 10 years and up. Adult supervision is recommended for those under 12 years of age.

SKILL LEVEL 2 ROCKET KITS

2123 EggsCaliber™

Length: 20 in (50.8 cm)
 Diameter: 1 in (25 mm)
 Estimated Weight. (without egg): 2.6 oz (74 g)
 Fins: Laser cut wood
 Recovery: 12 in (30.5 cm) Parachute and 18 in (46 cm) Parachute
 Projected Altitude: 1700 ft (518 m) without egg
 Recommended Engines: With egg – B6-2 (First Flight), C6-3, C11-3, D12-3, E9-4*; Without egg – B4-2 (First Flight), B6-2, C6-5, D12-5, E9-6*
 Requires 3/16 in (5 mm) Maxi™ launch rod (2244), sold separately.



2123 EggsCaliber™

2162 Big Daddy™

Length: 19 in (48.3 cm)
 Diameter: 3 in (76 mm)
 Estimated Weight: 5.3 oz (150.3 g)
 Fins: Laser cut wood
 Recovery: 24 in (61 cm) Parachute
 Projected Altitude: 900 ft (274 m)
 Recommended Engines: C11-3 (First Flight), D12-3, D12-5, E9-4*, E9-6*
 Requires 3/16 in (5 mm) Maxi™ Launch Rod (2244), sold separately.



2162 Big Daddy™

2447 Astron Elliptic II™

Length: 23.3 in (59.2 cm)
 Diameter: .74 in (19 mm)
 Estimated Weight: 1 oz (28.3 g)
 Fins: Laser cut wood
 Recovery: Streamer and Tumble
 Projected Altitude: 925 ft (282 m)
 Recommended Engines:
 Single Stage: 1/2A3-2T (First Flight), A3-4T, A10-3T
 Two Stage: Booster – A10-0T
 Upper – 1/2A3-4T (First Flight), 1/4A3-3T, A3-4T, A10-3T



2447 Astron Elliptic II™

2448 Mini Comanche-3™

Length: 31.1 in (79 cm)
 Diameter: .74 in (19 mm)
 Estimated Weight: 1.5 oz (42.5 g)
 Fins: Laser cut wood
 Recovery: Streamer
 Projected Altitude: 900 ft (274 m)
 Recommended Engines:
 Single Stage: 1/2A3-2T (First Flight), A3-4T, A10-3T
 Two or Three Stage:
 Booster and Second Stage: A10-0T
 Upper Stage: 1/4A3-3T (First Flight), 1/2A3-2T, A3-4T, A10-3T

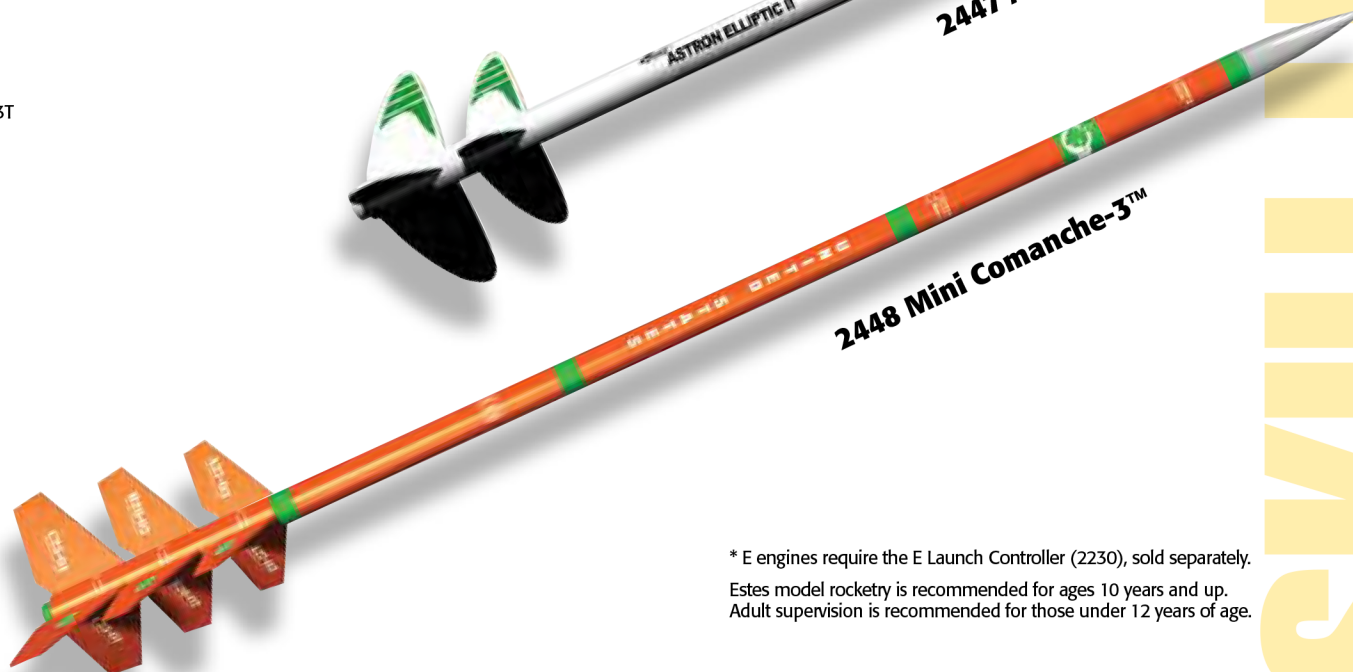

2448 Mini Comanche-3™

* E engines require the E Launch Controller (2230), sold separately.
 Estes model rocketry is recommended for ages 10 years and up.
 Adult supervision is recommended for those under 12 years of age.

SKILL LEVEL 2

SKILL LEVEL 2 ROCKET KITS

3026 Photon Probe™

Length: 23 in (58.4 cm)
Diameter: 1.33 in (34 mm)
Estimated Weight: 3.5 oz (99.2 g)
Fins: Laser cut wood
Recovery: 18 in (46 cm) Parachute
Projected Altitude: 575 ft (175 m)
Recommended Engines: B4-4 (First Flight), B6-4, C6-5

3217 Vagabond™

Length: 35.3 in (89.7 cm)
Diameter: 1.64 in (42 mm)
Estimated Weight: 4.1 oz (116.2 g)
Fins: Laser cut wood
Recovery: 18 in (46 cm) Parachute
Projected Altitude: 1,275 ft (389 m)
Recommended Engines: D12-5 (First Flight), D12-7, E9-6*, E9-8*
Requires 3/16 in (5 mm) Maxi™ launch rod (2244), sold separately.

3218 Laser Lance™

Length: 20.3 in (51.6 cm)
Diameter: 1.64 in (42 mm)
Estimated Weight: 2.8 oz (79.4 g)
Fins: Laser cut wood
Recovery: 12 in (30.5 cm) Parachute
Projected Altitude: 925 ft (282 m)
Recommended Engines: C11-3 (First Flight), C11-5, D12-5, D12-7

3219 Air Commander™

Length: 32.5 in (82.5 cm)
Diameter: 1.33 in (34 mm)
Estimated Weight: 3.8 oz (107.7 g)
Fins: Laser cut wood
Recovery: 18 in (46 cm) Parachute
Projected Altitude: 2250 ft (686 m)
Recommended Engines: Booster: Single Stage: C11-3 (First Flight), D12-5, D12-7; Two Stage: Booster: C11-0 (First Flight), D12-0; Upper Stage: C11-5 (First Flight), C11-7, D12-5, D12-7

3225 Solar Warrior™

Length: 27 in (68.6 cm)
Diameter: 1.64 in (42 mm)
Estimated Weight: 3.1 oz (87.9 g)
Fins: Laser cut wood
Recovery: 18 in (46 cm) Parachute
Projected Altitude: 925 ft (282 m)
Recommended Engines: C11-3 (First Flight), C11-5, D12-5, D12-7
Requires 3/16 in (5 mm) Maxi™ Launch Rod (2244), sold separately.



* E engines require the E Launch Controller (2230), sold separately.

Estes model rocketry is recommended for ages 10 years and up. Adult supervision is recommended for those under 12 years of age.

SKILL LEVEL 2 ROCKET KITS

3226 Hi-Flier® XL

Length: 31 in (78.7 cm)
 Diameter: 1.64 in (42 mm)
 Estimated Weight: 3.5 oz (99.2 g)
 Fins: Laser cut wood
 Recovery: 18 in (46 cm) Parachute
 Projected Altitude: 1,325 ft (404 m)
 Recommended Engines: C11-3 (First Flight), D12-5, D12-7, E9-6*, E9-8*
 Requires 3/16 in (5 mm) Maxi™ Launch Rod (2244), sold separately.



3227 Loadstar™ II

Length: 23.3 in (59.2 cm)
 Diameter: 1.64 in (42 mm)
 Estimated Weight: 2.8 oz (79.4 g)
 Fins: Laser cut wood
 Recovery: 12 in (30.5 cm) Parachute
 Projected Altitude: 1,000 ft (305 m)
 Recommended Engines: Single Stage: B4-4 (First Flight), B6-4 C6-5
 Two Stage:
 Booster Stage: B6-0 (First Flight), C6-0
 Upper Stage: A8-5 (First Flight), B6-4, B6-6, C6-7

3232 Centuri®

Length: 29.3 in (74.4 cm)
 Diameter: 1.33 in (34 mm)
 Estimated Weight: 3.1 oz (87.9 g)
 Fins: Laser cut wood
 Recovery: Parachute
 Projected Altitude: 600 ft (183 m)
 Recommended Engines: B4-4 (First Flight), B6-4, C6-5



3233 Blenders™

Length: 2.6 in (6.6 cm)
 Diameter: 4.8 in (12.2 cm)
 Estimated Weight: .4 oz (11.3 g)
 Fins: Laser cut wood
 Recovery: Spin
 Projected Altitude: 75 ft (23 m)
 Recommended Engine: A10-OT



3234 JBR-013™

Length: 18.4 in (46.7 cm)
 Diameter: 1.33 in (34 mm)
 Estimated Weight: 1.9 oz (53.9 g)
 Fins: Laser cut wood
 Recovery: Parachute
 Projected Altitude: 775 ft (236 m)
 Recommended Engines: B4-4 (First Flight), B6-4, C6-5, C6-7

7000 Bull Pup 12D

Length: 15.6 in (39.6 cm)
 Diameter: 1.33 in (34 mm)
 Estimated Weight: 1.8 oz (51 g)
 Fins: Laser cut wood
 Recovery: 12 in (30.5 cm) Parachute
 Projected Altitude: 675 ft (206 m)
 Recommended Engines: A8-3 (First Flight), B4-4, B6-4, C6-5



* E engines require the E™ Launch Controller (2230), sold separately.

Estes model rocketry is recommended for ages 10 years and up. Adult supervision is recommended for those under 12 years of age.

SKILL LEVEL 2 ROCKET KITS

7216 EPM-010™

Length: 35.25 in (89.5 cm)
 Diameter: .98 in (25 mm)
 Estimated Weight: 2.4 oz (68 g)
 Fins: Laser cut wood
 Recovery: 12 in (30.5 cm) Parachute
 Projected Altitude: 925 ft (282 m)
 Recommended Engines: B4-4, B6-4 (First Flight), C6-3, C6-5



7217 Hyper Bat™

Length: 21.9 in (55.6 cm)
 Diameter: .98 in (25 mm)
 Estimated Weight: 1.8 oz (51 g)
 Fins: Laser cut wood
 Recovery: 12 in (30.5 cm) Parachute and Tumble
 Projected Altitude: 2,125 ft (648 m)
 Recommended Engines:
 Single Stage: B6-4, (First Flight), B6-6, C6-5, C6-7
 Two Stage: Booster: A8-0, B6-0 (First Flight), C6-0
 Upper Stage: A8-5, B6-6 (First Flight), C6-5, C6-7

7221 STM-012™

Length: 44.4 in (112.8 cm)
 Diameter: 1.64 in (42 mm)
 Estimated Weight: 5.7 oz (161.6 g)
 Fins: Laser cut wood
 Recovery: Parachute
 Projected Altitude: 1125 ft (343 m)
 Recommended Engines: C11-3 (First Flight), D12-5, E9-4*, E9-6*, E12-6*
 Requires 3/16 in (5 mm) Maxi™ launch rod (2244), sold separately.



7223 Rogue Voyager™

Length: 22.1 in (56.1 cm)
 Diameter: .98 in (25 mm)
 Estimated Weight: 2.5 oz (70.9 g)
 Fins: Laser cut wood
 Recovery: Parachute
 Projected Altitude: 550 ft (168 m)
 Recommended Engines: B6-4 (First Flight), C6-5

7224 Astron Sprint XL™

Length: 22.8 in (57.9 cm)
 Diameter: 1.64 in (42 mm)
 Estimated Weight: 3.4 oz (96.4 g)
 Fins: Laser cut wood
 Recovery: Parachute
 Projected Altitude: 1300 ft (396 m)
 Recommended Engines: C11-3 (First Flight), D12-5, E9-6*, E9-8*, E12-6*, E12-8*
 Requires 3/16 in (5 mm) Maxi™ launch rod (2244), sold separately.



* E engines require the E Launch Controller (2230), sold separately.

Estes model rocketry is recommended for ages 10 years and up. Adult supervision is recommended for those under 12 years of age.

SKILL LEVEL 3 ROCKET KITS

2134 MIRV™

Length: 24.5 in (62.2 cm)
 Diameter: 1.64 in (42 mm)
 Estimated Weight: 4.7 oz (134 g)
 Fins: Laser cut wood
 Projected Altitude: 600 ft (183 m)
 Recommended Engines:
 Booster Stage: B6-0, (First Flight) C6-0
 Second Stage: A10-3T Only (Requires three A engines
 and one B or C booster engine per launch.)

2425 Super Neon XL™

Length: 37.75 in (95.9 cm)
 Diameter: 1.64 in (42 mm)
 Estimated Weight: 7 oz (198 g)
 Fins: Laser cut wood
 Recovery: 24 in (61 cm) Parachute
 Projected Altitude: 1,000 ft (305 m)
 Recommended Engines: D12-5 (First Flight), E9-4*, E9-6*
 Requires 3/16 in (5 mm) Maxi™ launch rod (2244), sold separately.

2440 Magician™

Length: 33.5 in (85 cm)
 Diameter: 1.33 in (34 mm)
 Estimated Weight: 3.5 oz (100 g)
 Fins: Laser cut wood
 Recovery: 18 in (46 cm) Parachute
 Projected Altitude: 1,600 ft (488 m)
 Recommended Engines: D12-5 (First Flight), E9-6*
 Requires 3/16 in (5 mm) Maxi™ launch rod (2244), sold separately.

3222 Tercel™

Length: 16.5 in (41.9 cm)
 Diameter: .54 in (14 mm)
 Wingspan: 10.9 in (27.7 cm)
 Estimated Weight: .78 oz (22.1 g)
 Fins: Laser cut wood
 Recovery: 6 in (15 cm) Parachute and glider
 Projected Altitude: 700 ft (213 m)
 Recommended Engines: 1/2A3-2T (First Flight), A3-4T, A10-3T

3228 V2 Semi-scale Model

Length: 22.4 in (56.9 cm)
 Diameter: 2.6 in (66 mm)
 Estimated Weight: 6.3 oz (178.6 g)
 Fins: Laser cut wood
 Recovery: 18 in (46 cm) Parachute
 Projected Altitude: 725 ft (221 m)
 Recommended Engines: C11-3 (First Flight),
 D12-3, E9-4*, E9-6*
 Requires 3/16 in (5 mm) Maxi™ Launch Rod (2244), sold separately.

3229 Astron Skydart II™

Length: 15.4 in (39.1 cm)
 Diameter: .98 in (25 mm)
 Wingspan: 12.5 in (31.8 cm)
 Estimated Weight: 3.1 oz (87.9 g)
 Fins: Laser cut wood
 Recovery: 12 in (30.5 cm) Parachute & Glider
 Projected Altitude: 500 ft (152 m)
 Recommended Engines: B6-2 (First Flight), C6-3

7225 Extreme 12™

Length: 46.4 in (117.8 cm)
 Diameter: 1.64 in (42 mm)
 Estimated Weight: 7.1 oz (201.3 g)
 Fins: Laser cut wood
 Recovery: Parachute
 Projected Altitude: 1900 ft (579 m)
 Recommended Engines:
 Single Stage: D12-3, D12-5(First Flight), E9-4*, E9-6*, E12-6*
 With Booster:
 D12-0: D12-5 (First Flight) E9-6*, E12-6*
 E12-0*: D12-5 (First Flight), D12-7, E9-6*, E12-6*, E12-8*
 Requires 3/16 in (5 mm) Maxi™ launch rod (2244), sold separately.

7228 Cobra™

Length: 16.2 in (41.1 cm)
 Diameter: .98 in (42 mm)
 Wingspan: 8 in (20.3 cm)
 Estimated Weight: 2.9 oz (82.2 g)
 Recovery: Parachute
 Projected Altitude: 925 ft (282 m)
 Recommended Engines: B4-2 (First Flight), B6-2, C6-3, C6-5



* E engines require the E™ Launch Controller (2230), sold separately.

Estes model rocketry is recommended for ages 10 years and up.
 Adult supervision is recommended for those under 12 years of age.

SKILL LEVEL 4 ROCKET KITS

1351 Cosmic Interceptor™

Length: 40.5 in (102.9 cm)
 Diameter: 2 in (51 mm)
 Estimated Weight: 10.1 oz (286.3 g)
 Fins: Laser cut wood
 Recovery: Nylon parachute
 Projected Altitude: 625 ft (190 m)
 Recommended Engines: D12-3 (First Flight), E9-4*, E12-4*,
 PSII E30-4T
 Requires 3/16 in (5 mm) Maxi™ launch rod (2244), sold separately.

3221 QCC Explorer™

Length: 35 in (88.9 cm)
 Diameter: 1.64 in (42 mm)
 Estimated Weight: 5 oz (141.2 g)
 Fins: Laser cut wood
 Recovery: 18 in (46 cm) Parachute
 Projected Altitude: 1225 ft (373 m)
 Recommended Engines: C11-3 (First Flight),
 D12-5, E9-4*, E9-6*
 Requires 3/16 in (5 mm) Maxi™ launch rod
 (2244), sold separately.

7229 Dark Silver™

Length: 29.8 in (75.7 cm)
 Diameter: 1.33 in (34 mm)
 Estimated Weight: 4.1 oz (116.2 g)
 Recovery: Parachute
 Projected Altitude: 400 ft (122 m)
 Recommended Engines: C6-3

SKILL LEVEL 5 ROCKET KITS

3223 Xarconian Cruiser™

Length: 22.7 in (57.7 cm)
 Diameter: 1.33 in (34 mm)
 Estimated Weight: 3.7 oz (105 g)
 Wing Span: 8.4 in (21.3 cm)
 Fins: Laser cut wood
 Recovery: 18 in (46 cm) Parachute
 Projected Altitude: 525 ft (160 m)
 Recommended Engines: B6-2 (First Flight), C6-3

3224 Asteroid Hunter™

Length: 16.2 in (41.1 cm)
 Diameter: .98 in (25 mm)
 Wingspan: 8 in (20.3 cm)
 Estimated Weight: 4.4 oz (124.7 g)
 Fins: Laser cut wood
 Recovery: Two 12 in (30.5 cm) Parachutes
 Projected Altitude: 500 ft (152 m)
 Recommended Engine: C6-3

7222 Black Star Voyager™

Length: 39.7 in (100.8 cm)
 Diameter: 1.64 in (42 mm)
 Estimated Weight: 7 oz (198.4 g)
 Fins: Laser cut wood
 Recovery: Parachute
 Projected Altitude: 1100 ft (336 m)
 Recommended Engines: D12-3 (First Flight), E9-4*, E12-4*
 Requires 3/16 in (5 mm) Maxi™ launch rod (2244), sold separately.

7230 Conquest™

Length: 28.6 in (72.6 cm)
 Diameter: 1.64 in (42 mm)
 Wingspan: 12.8 in (32.5 cm)
 Estimated Weight: 5.5 oz (155.9 g)
 Recovery: Parachute
 Projected Altitude: 1100 ft (335 m)
 Recommended Engines: D12-3 (First Flight), E9-4, E12-4*
 Requires 3/16 in (5 mm) Maxi™ launch rod (2244), sold separately.

* E engines require the E™ Launch Controller (2230), sold separately.

Estes model rocketry is recommended for ages 10 years and up.
 Adult supervision is recommended for those under 12 years of age.

ESTES MODEL ROCKET ENGINES

The famous model rocket engines that made model rocketry the great activity it is today. Estes model rocket engines have been proven consistent and reliable in more than 275,000,000 launches.

- The concept of a factory assembled model rocket engine is the foundation of this scientific and educational activity!
- 3% of all Estes engines are static-tested at the factory for reliability and adherence to performance specifications.
- All engines comply with the code requirements of the National Fire Protection Association and are certified by the National Association of Rocketry.



HOW DOES A MODEL ROCKET ENGINE WORK?

1. When engine is ignited, it produces thrust and boosts rocket into sky.

2. After propellant is used up, delay is activated, producing tracking smoke and allowing rocket to coast.

3. After delay, ejection charge is activated, deploying recovery system.

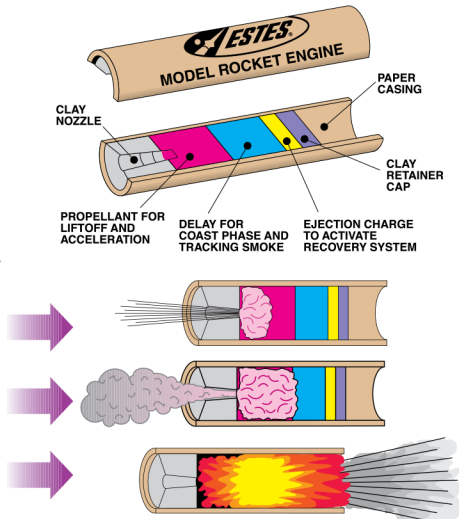

WHAT SIZES ARE AVAILABLE?

Estes engines are available in a wide variety of sizes and power levels:

TYPE	TOTAL IMPULSE	ENGINE TYPES
1/4A	0.313 - 0.625	Mini
1/2A	0.626 - 1.25	Standard, Mini
A	1.26 - 2.50	Standard, Mini
B	2.51 - 5.00	Standard
C6	5.01 - 10.00	Standard
C11	5.01 - 10.00	D Size
D	10.01 - 20.00	D Size
E	20.01 - 30.00	E Size
F	45.01 - 50.00	F Size

Each engine type is color coded.

- Single Stage - Green**
- Upper Stage - Purple** (Upper stage engines can be used as single stage engines in lightweight rockets.)
- Booster - Red** (Booster engines contain no delay or ejection charge.)
- Plugged - Blue** (Plugged engines are used for R/C gliders and contain no delay or ejection charge.)

Each engine has an alpha-numeric code printed on it.

B = TOTAL IMPULSE
This letter is the total power (in Newton-seconds) produced by the engine. Each succeeding letter has up to twice the total power as the previous letter. (Example: "B" engines have up to twice the power of "A" engines, which results in approximately twice the altitude the rocket will reach.)

6 = AVERAGE THRUST
This number shows the engine's average push or how fast the engine powers the rocket to go. The higher the number, the faster the speed. It is measured in Newtons (4.45 Newtons = 1 lb.).

4 = TIME DELAY
This number gives you the time delay in seconds between the end of the thrust phase and ignition of the ejection charge. Engine types ending in "0" have no time delay or ejection and are used for booster stages and special purposes only. Engines ending in "P" have no time delay or ejection charge and the forward end is plugged.

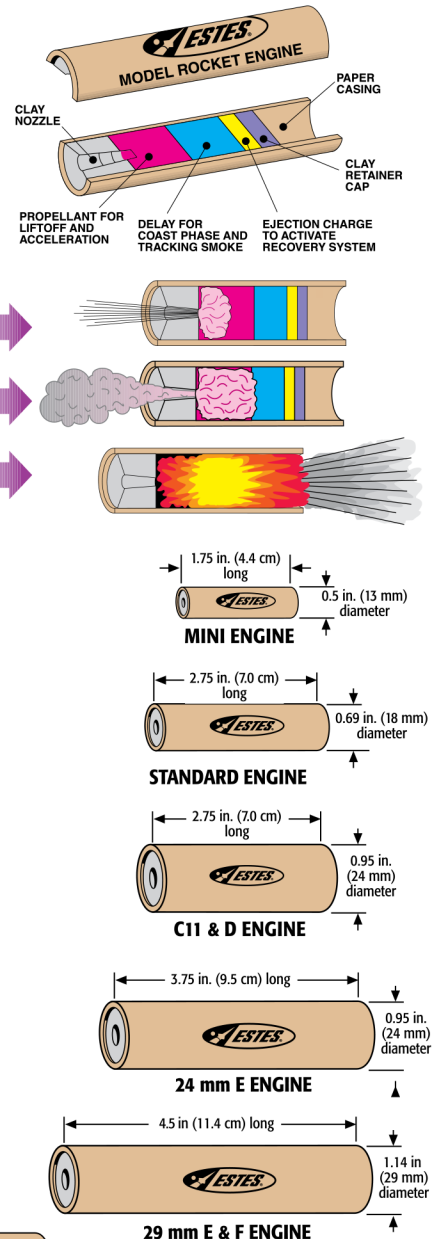

MODEL ROCKET ENGINE CHART

- Delays have a tolerance of plus or minus 10% or one second, whichever is greater.
- All Estes engines come complete with starters (patent pending) and starter plugs. The Estes starter plug makes engine ignition extremely reliable.
- Do not fly a rocket/engine combination whose liftoff weight exceeds the recommended maximum liftoff weight.

Prod. No.	Engine Type	Total Impulse		Time Delay		Max. Thrust		Thrust Duration		Initial Weight		Propellant Weight	
		N-sec	Sec.	Oz.	g	Newtons	lbs.	Sec.	Oz.	g	Oz.	g	
SINGLE STAGE ENGINES													
1502	1/4A3-3T*	0.625	3	1.0	28	4.9	1.1	0.25	0.21	5.9	0.46	1.3	
1503	1/2A3-2T*	1.25	2	2.0	57	8.3	1.9	0.3	0.23	6.4	0.07	1.9	
1507	A3-4T*	2.50	4	2.0	57	6.8	1.5	0.6	0.28	8	0.12	3.3	
1511	A10-3T*	2.50	3	3.0	85	13.0	2.9	0.8	0.29	8.1	0.12	3.5	
1593	1/2A6-2	1.25	2	2.0	57	8.9	2.0	0.3	0.48	13.6	0.10	2.7	
1598	A8-3	2.50	3	3.0	85	10.7	2.4	0.5	0.55	15.5	0.14	4.1	
1601	B4-2	5.00	2	4.0	113	13.2	3.0	1.1	0.66	18.6	0.27	7.6	
1602	B4-4	5.00	4	3.5	99	13.2	3.0	1.1	0.68	19.2	0.27	7.6	
1605	B6-2	5.00	2	4.5	127	12.1	2.7	0.8	0.61	17.3	0.23	6.5	
1606	B6-4	5.00	4	4.0	113	12.1	2.7	0.8	0.63	17.8	0.23	6.5	
1613	C6-3	10.00	3	4.0	113	15.3	3.4	1.6	0.83	23.4	0.43	12.2	
1614	C6-5	10.00	5	4.0	113	15.3	3.4	1.6	0.85	24	0.43	12.2	
1522	C11-3	10.00	3	6.0	170	22.1	4.9	0.8	1.13	32.1	0.44	12.4	
1523	C11-5	10.00	5	5.0	142	22.1	4.9	0.8	1.18	33.4	0.44	12.4	
1566	D12-3	20.00	3	14.0	396	32.9	7.4	1.6	1.57	44.5	0.85	24.2	
1567	D12-5	20.00	5	10.0	283	32.9	7.4	1.6	1.61	45.7	0.85	24.2	
1573	E9-4	30.00	4	15.0	425	25.0	5.6	2.8	2.16	61.2	1.30	36.9	
1574	E9-6	30.00	6	12.0	340	25.0	5.6	2.8	2.23	63.2	1.30	36.9	
1582	E12-4	30.00	4.6	17.0	482	30.6	6.9	2.7	2.16	61.2	1.30	36.9	
1583	E12-6	29.50	7	14.0	397	29.6	6.7	2.7	2.23	63.2	1.30	36.9	
1651	F15-4	49.61	4	21	595	25.26	5.7	3.45	3.59	101.5	2.12	60	
1652	F15-6	49.61	6	17	482	25.26	5.7	3.45	3.66	103.7	2.12	60	
1696	E16-4	33.68	4	20	566	26.44	5.9	2.09	2.86	81.0	1.41	40	
1697	E16-6	33.68	6	16	453	26.44	5.9	2.09	2.92	82.7	1.41	40	
UPPER STAGE ENGINES													
1504	1/2A3-4T*	1.25	4	1.0	28	8.3	1.9	0.3	0.23	6.6	0.07	1.9	
1599	A8-5	2.50	5	2.0	57	13.3	3.0	0.5	0.55	15.7	0.14	4.1	
1607	B6-6	5.00	6	2.5	71	12.1	2.7	0.8	0.64	18.2	0.23	6.5	
1615	C6-7	10.00	7	2.5	71	15.3	3.4	1.6	0.85	24.3	0.43	12.2	
1524	C11-7	10.00	7	4.0	113	22.1	4.9	0.8	1.19	33.8	0.44	12.4	
1568	D12-7	20.00	7	8.0	226	32.9	7.4	1.6	1.62	46.0	0.85	24.2	
1575	E9-8	30.00	8	10.0	283	25.0	5.6	2.8	2.24	63.5	1.30	36.9	
1584	E12-8	29.80	8	12.0	340	31.8	7.1	2.7	2.24	63.5	1.30	36.9	
1653	F15-8	49.61	8	15	425	25.26	5.7	3.45	3.69	104.4	2.12	60	
1698	E16-8	33.68	8	14	396	26.44	5.9	2.09	2.99	84.7	1.41	40	

The data listed above is from randomly chosen production samples.
NOTE: The "T" designates a mini engine.

MODEL ROCKET ENGINE CHART CONTINUED

Prod. No.	Engine Type	Total Impulse	Time Delay	Max. Lift Wt.		Max. Thrust		Thrust Duration	Initial Weight		Propellant Weight	
		N-sec	Sec.	Oz.	g	Newtons	lbs.	Sec.	Oz.	g	Oz.	g
BOOSTER STAGE ENGINES												
1510	A10-0T*	2.50	None	4.0	113	13	2.9	0.8	0.24	6.8	0.12	3.5
1600	A8-0	2.50	None	3.0	85	13.3	3.0	0.3	0.47	13.5	0.14	4.1
1608	B6-0	5.00	None	4.0	113	12.1	2.7	0.8	0.55	15.7	0.23	6.5
1616	C6-0	10.00	None	4.0	113	15.3	3.4	1.6	0.76	21.4	0.43	12.2
1521	C11-0	10.00	None	6.0	170	22.1	4.9	0.8	1.03	29.2	0.44	12.4
1565	D12-0	20.00	None	14.0	396	32.9	7.4	1.6	1.43	40.4	0.84	23.8
1581	E12-0	28.80	None	16.0	454	31.3	7.0	2.6	2.05	58.1	1.30	36.9
1650	F15-0	49.61	None	19	539	25.26	5.7	3.45	3.32	94.0	2.12	60
1695	E16-0	33.68	None	18	509	26.44	5.9	2.09	2.58	73.2	1.41	40
PLUGGED ENGINES - FOR USE WITH ROCKET POWERED RACERS & R/C ROCKET GLIDERS												
1505	A10-PT*	2.50	None	3.0	85	13.0	2.9	0.8	0.26	7.4	0.13	3.78

* There are 4 mini engines per package. All other engines are 2 or 3 per package.

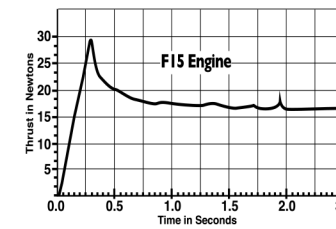
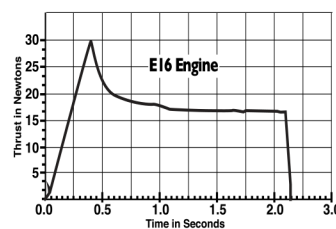
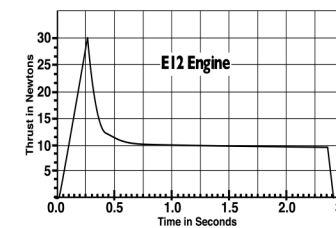
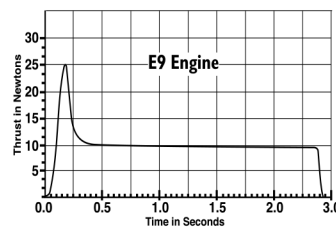
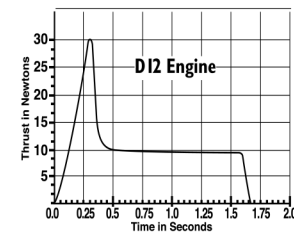
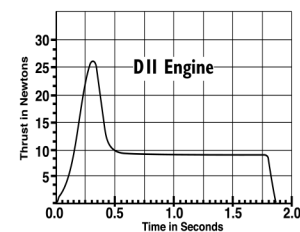
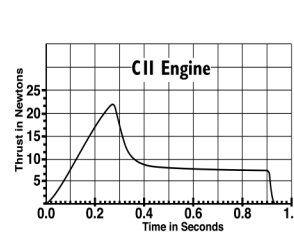
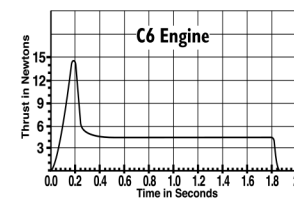
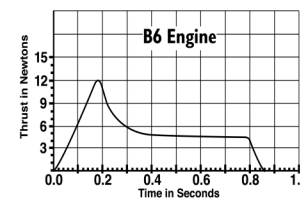
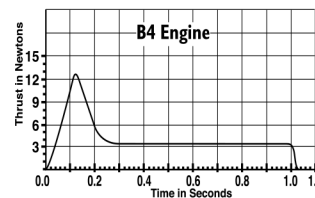
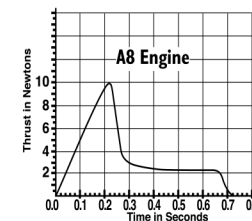
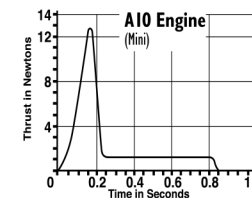
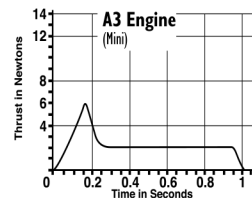

ENGINE TIME/THRUST CURVES

- Time/thrust curves are representative of random production samples
- Graphs are not drawn to the same scale

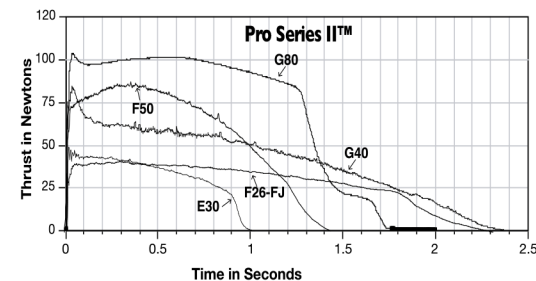
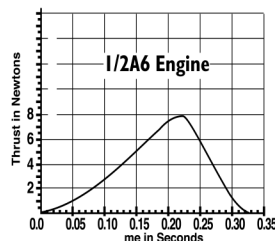
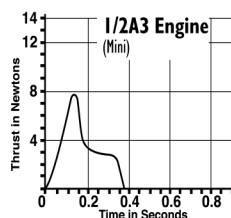
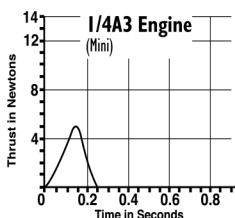
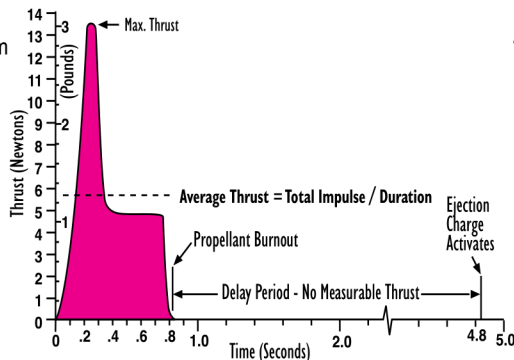

MODEL ROCKET ACCESSORIES



1672 BLAST-OFF® FLIGHT PACK
Includes 6 each of A8-3, B6-4, C6-3, C6-5 engines, 30 starters, 30 starter plugs and 75 sheets of recovery wadding.

2221 Astron II™ LAUNCH CONTROLLER
Comes assembled with safety key and 17 ft (5.2 m) of cable. Requires 1 9V alkaline battery - not included.

2225 Astron II™ LAUNCH PAD AND CONTROLLER
Quick assembly - no glue or tools required! Comes complete with blast deflector, standoff, two-piece 1/8 in (3 mm) launch rod and safety cap. Controller comes with 17 ft (5.2 m) of cable. Requires 1 9V alkaline battery - not included.

2239 Astron II™ LAUNCH PAD
Quick assembly - no glue or tools required! Comes complete with blast deflector, standoff, two-piece 1/8 in (3 mm) launch rod and safety cap.



2230 E™ LAUNCH CONTROLLER
Comes assembled with safety key and 30 ft (9 m) of cable. Requires 4 AA alkaline batteries - not included. Adult supervision is recommended for anyone under 18 when launching E engine powered rockets.

2238 PORTA-PAD® E LAUNCH PAD
Quick assembly - no glue or tools required. Launch rod angle is adjustable. Includes a 1/4 in (6 mm) launch rod, but can accommodate a 3/16 in (5 mm) Maxi™ launch rod - not included. Adult supervision recommended for anyone under 18 when launching E engine powered rockets.



2215 PORTA-PAD® II LAUNCH PAD
Quick assembly - no glue or tools required! Launch rod angle is adjustable. Comes complete with blast deflector, standoff, two-piece 1/8 in (3 mm) launch rod and safety cap. Can accommodate a 3/16 in (5 mm) Maxi™ launch rod - not included.

2220 ELECTRON BEAM® LAUNCH CONTROLLER
Launch controller comes assembled with safety key and 15 ft (4.6 m) of cable. Requires four AA alkaline batteries - not included.

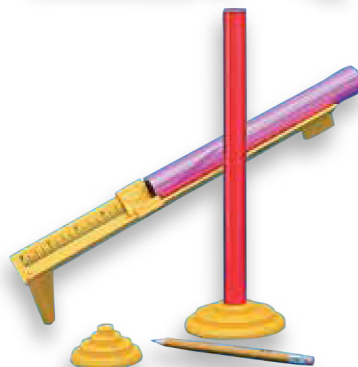

2227 TUBE MARKING GUIDE
Easy way to mark fin and launch lug placement lines. Also includes a fin gluing jig. Body tube not included.

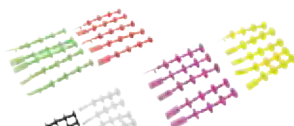

2250 1/4A3, 1/2A3, A3 and A10 Engine Plugs
5 Orange, 5 Green
2251 1/2A6, A8, B4, B6, C6 and E12 Engine Plugs
5 Magenta, 5 Yellow
2252 C11, D12, E9, E16 and F15 Engine Plugs
5 White, 5 Black



2228 ULTIMATE TUBE MARKING GUIDE
Marks body tube for accurate fin placement.



2231 FIN ALIGNMENT GUIDE
Fast and accurate fin alignment for three- or four-finned rockets.

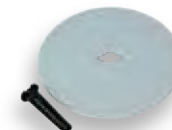

2241 BLAST DEFLECTOR PLATE
Replaces that worn-out deflector. For use with 2215 and 2239



2232 ALITRAK™
Measure altitude with this easy to use device. Follow the rocket in the sights to apogee, release the trigger to lock the reading.



2246 ALTIMETER
Record up to 10 flights. LCD display, battery included.



2243 1/8 in (3 mm) TWO-PIECE LAUNCH ROD
Replacement rod ideal for most rockets.

2244 3/16 in (5 mm) TWO-PIECE MAXI™ LAUNCH ROD
Launch rod with extra strength and length for larger rockets.

2262 6 in (15.2 cm) PARACHUTE (Assembled)

2264 12 in (30.5 cm) PARACHUTE (Assembled)

2265 15 in (38 cm) PARACHUTE (Assembled)

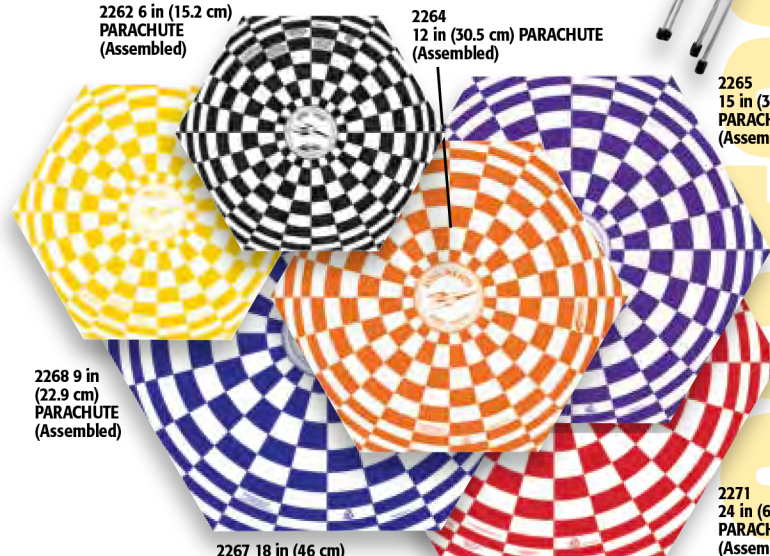

2268 9 in (22.9 cm) PARACHUTE (Assembled)

2267 18 in (46 cm) PARACHUTE (Assembled)

2271 24 in (61 cm) PARACHUTE (Assembled)

MODEL ROCKET ACCESSORIES



2274 RECOVERY WADDING
Flame resistant wadding protects recovery system. Required in most Estes rockets. Contains 75 sheets – enough for about 18-25 flights!



2278 SHOCK CORDS & MOUNT PACK
Includes three 1/8 in x 36 in (3 mm x 914 mm) and one 1/4 in x 36 in (6 mm x 914 mm) rubber shock cords (enough for four shock cords). Includes shock cord mounts and instructions.



2302 MODEL ROCKET STARTERS*
Dependable, easy-to-use Estes starters in a convenient six pack. It's always a good idea to have a few spares.
*Patent pending

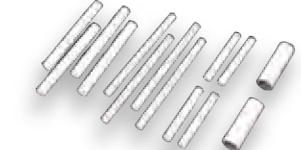

2320 LAUNCH LUG PACK
Contains 4 each: 1/8 x 2 3/8 in (3 x 60 mm), 1/8 x 1 1/4 in (3 x 32 mm), 3/16 x 2 in (5 x 51 mm) and 1/4 x 1 in (6 x 25 mm) launch lugs.



2315 TUBE CUTTING GUIDES
Assorted sizes: BT-5, BT-20, BT-50, BT-55, and BT-60 (hobby knife not included)

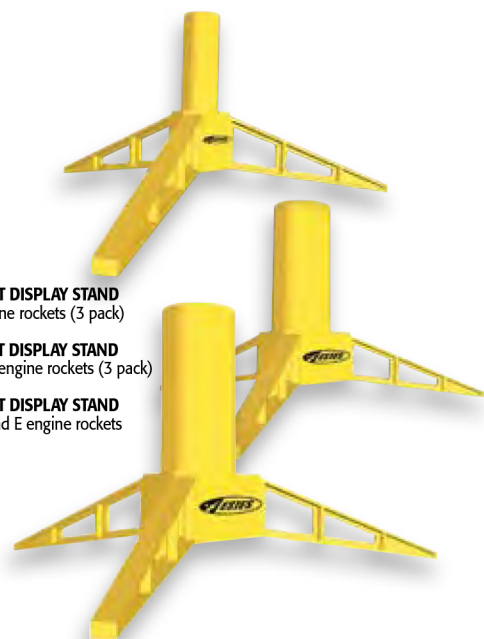

2290 ROCKET DISPLAY STAND
For mini engine rockets (3 pack)

2291 ROCKET DISPLAY STAND
For standard engine rockets (3 pack)

2292 ROCKET DISPLAY STAND
For C11, D and E engine rockets (3 pack)

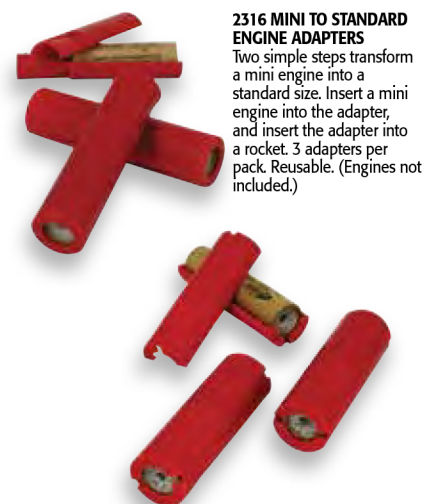

2316 MINI TO STANDARD ENGINE ADAPTERS
Two simple steps transform a mini engine into a standard size. Insert a mini engine into the adapter, and insert the adapter into a rocket. 3 adapters per pack. Reusable. (Engines not included.)



2317 STANDARD TO D ENGINE ADAPTERS
Two simple steps transform a standard engine into a D size. Insert a standard engine into the adapter, and insert the adapter into a rocket. 3 adapters per pack. Reusable. (Engines not included.)

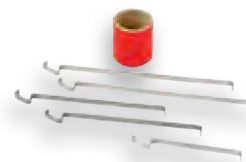

3143 ENGINE HOOK ACCESSORY PACK
Hooks fit mini engines (one), regular and D engines (three) and E engines (two). Includes spacer for E engine hooks.



3159 D AND E ENGINE MOUNT KIT
Heavy duty engine mounts for D and E engines. Fits BT-55, 60 and 80 tubes.



3158 REGULAR ENGINE MOUNT KIT
Fits BT-50, 55 and 60 tubes. Can also be used to make a conversion mount for lightweight D powered rockets.



3196 Large Tube Coupler Pack
Includes two couplers for BT-55, BT-56 and BT-60; One for BT-80.

NOSE CONE ASSORTMENTS

Each package of nose cones may contain a variety of shapes. Some are one piece, others two piece. All have eyelets for shock cord and shroud line attachments.

- 3160 NC-5 NOSE CONE ASSORTMENT (5 pack)
- 3161 NC-20 NOSE CONE ASSORTMENT (4 pack)
- 3162 NC-50 NOSE CONE ASSORTMENT (5 pack)
- 3163 NC-55 NOSE CONE ASSORTMENT (4 pack)
- 3164 NC-56 NOSE CONE ASSORTMENT (4 pack)
- 3165 NC-60A NOSE CONE ASSORTMENT (4 pack)
- 3168 NC-80B NOSE CONE (1 pack)
- 3173 SCI-FI NOSE CONE ASSORTMENT (5 pack)

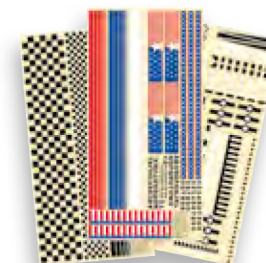

3170 WATERSLIDE DECAL SET



3171 Clear Payload Assortment

BODY TUBES

High quality spiral wound paper tubes. Use tube couplers to connect tubes of the same diameter. Four tubes per package with BT-5 & BT-20, three per package with BT-50, BT-55 and BT-60 and two per package in BT-80.

Product Number	Body Tube Size	Inside Dimension in./mm	Outside Dimension in./mm	Length in/cm
3084	BT-5	.52/13	.54/14	18.0/45.7
3085	BT-20	.71/18	.74/19	18.0/45.7
3086	BT-50	.95/24	.98/25	18.0/45.7
3087	BT-55	1.28/33	1.33/34	18.0/45.7
3089	BT-60	1.60/41	1.64/42	18.0/45.7
3090	BT-80	2.56/65	2.60/66	14.2/36.1



9751 24 mm Motor Retainer Set (2 sets)

Contents and specifications subject to change without notice.



GET YOUNG PEOPLE EXCITED ABOUT LEARNING!

Inspiring students and young people – that’s what Estes Educator is here to do! Just log onto EstesEducator.com to find everything you need for your classroom or youth organization. We’ve made it easy to bring the fun of model rockets to your students.



- Free lesson plans
- Automated list of items needed
- Links to funding and grants
- Extensive resource materials
- Special discount bulk packs

Estes Makes it EASY!

“Estes model rockets are the best hands-on activity I have ever done with my students!”

FREE LESSON PLANS ONLINE

Use the handy pull-down menus to:

- Choose a grade level
- Choose a subject
- Choose the number of classroom sessions

The perfectly matched lesson plan will be displayed!

All matched to National Learning Standards



AUTOMATED LIST OF ITEMS NEEDED

After choosing a lesson plan, just enter the number of students and our website will automatically display a list of recommended rockets and accessories. We’ve removed the guesswork and determined the best, most budget-friendly choices for you.

LINKS TO FUNDING

We’ve located a number of organizations that support teaching with model rockets. From EstesEducator.com, you can link directly to funding opportunities to get the application process started. Many are easy to request and you can expect a response quickly.

EXTENSIVE RESOURCES ONLINE

In addition to free lesson plans, we have many resources available and easily accessed. At EstesEducator.com you can find useful information about:

- How to Choose a Launch Site
- The Basics of Model Rocketry
- Reference Guide for Teachers and Youth Group Leaders
- Worksheets for the Classroom
- Videos, Curricula and much more





SPECIAL BULK PACKS FOR EDUCATORS

Estes offers 12- and 24-piece discount Bulk Packs especially for educators and youth group leaders. Bulk Packs are available for a variety of rockets, including E2X® Easy To Assemble Rockets and Skill Level 1 and 2 Rocket Kits. (Rocket Engines, Recovery Wadding, Starters and Starter Plugs are sold separately.)

AIR POWERED PARTY PACK ROCKETS



1700 T-Bolt™ Party Pack Rocket Set
 6 Ready to fly rockets
 Length: 11.5 in (29.2 cm)
 Estimated Weight: .87 oz (24.7 g)
 Fins: Foam
 Recovery: Bounce
 Projected Altitude: 150 ft (46 m)



1708 Rocket-Star™ Party Pack Rocket Set
 12 Rockets
 Length: 8.8 in (22.4 cm)
 Fins: Foam
 Recovery: Bounce
 Projected Altitude: 50 ft (15.2 m)



E2X® EASY TO ASSEMBLE BULK PACK ROCKETS

E2X Kits can be assembled in about one hour. Simply glue the parts together according to the instructions, apply decals and attach the parachute. They require no special tools or painting.



Note: The individual sale Color the Sky rockets (1100-1111) are Ready to Fly and do not require assembly.

1715 Color the Sky™ (12-pack*)
 Length: 19.8 in (50.3 cm)
 Recommended Engines: B4-2 (First Flight), B6-2, B6-4, C6-5



1750 Gnome™ (24-pack*)
 Length: 10.3 in (26.2 cm)
 Recommended Engines: 1/2A3-2T (First Flight), 1/2A3-4T, A3-4T, A10-3T



1751 Alpha® III (12-pack)
 Length: 12.3 in (31.2 cm)
 Recommended Engines: 1/2A6-2, A8-3 (First Flight), A8-5, B4-4, B6-4, B6-6, C6-5, C6-7



1764 Generic E2X® (12-pack)
 Length: 13.6 in (34.5 cm)
 Recommended Engines: 1/2A6-2, A8-3 (First Flight), A8-5, B4-4, B6-4, B6-6, C6-5, C6-7



1792 Firestreak SST™ (24-pack*)
 Length: 10.2 in (25.9 cm)
 Quick Snap – No Gluing!
 Recommended Engines: 1/2A3-2T (First Flight), 1/2A3-4T, A3-4T, A10-3T



1793 UP Aerospace™ SpaceLoft™ (12-pack)
 Length: 11.1 in (28.2 cm)
 Recommended Engines: 1/2A3-2T (First Flight), 1/2A3-4T, A3-4T, A10-3T

1753 AVG BULK PACK (12-pack) 4 of each rocket

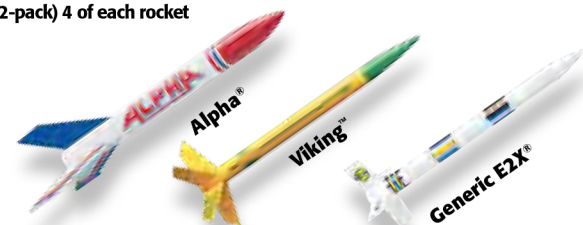

Recommended Engines: 1/2A6-2, A8-3 (First Flight), A8-5, B4-4, B6-4, B6-6, C6-5, C6-7

* Quantity subject to change

SKILL LEVEL 1 & 2 BULK PACK ROCKET KITS

Skill Level 1 & 2 Rocket Kits require more model building and decorating. Most can be built in less than two hours and require fins to be assembled and some painting.



1722 Comet Chaser™ (12-pack)
Skill Level 1
Length: 14.4 in (36.5 cm)
Recommended Engines: A8-3, (First Flight), B6-4, C6-5, C6-7

1754 Wizard™ (12-pack)
Skill Level 1
Length: 12 in (30.5 cm)
Recommended Engines: 1/2A6-2, A8-3 (First Flight), A8-5, B4-4, B6-4, B6-6, C6-5, C6-7

1755 Viking™ (12-pack)
Skill Level 1
Length: 12.1 in (30.7 cm)
Recommended Engines: 1/2A6-2, A8-3 (First Flight), A8-5, B4-4, B6-4, B6-6, C6-5, C6-7



1756 Alpha® (12-pack)
Skill Level 1
Length: 12.3 in (31.2 cm)
Recommended Engines: 1/2A6-2, A8-3 (First Flight), A8-5, B4-4, B6-4, B6-6, C6-5, C6-7

1760 Loadstar™ II (12-pack)
Skill Level 2
Length: 23.3 in (59.2 cm)
Recommended Engines:
Single Stage: B4-4 (First Flight), B6-4 C6-5;
Two Stage: Booster Stage: B6-0 (First Flight), C6-0; Upper Stage: A8-5 (First Flight), B6-4, B6-6, C6-7

ROCKET ENGINE BULK PACKS

Every launch requires Engines, Recovery Wadding, Starters and Plugs. These convenient Engine Bulk Packs include enough of each for 24 launches. Choose from a variety of engine sizes. We advise using the smallest recommended engine for first flights.



- 1781 A8-3 Engines (24)
- 1783 B6-4 Engines (24)
- 1784 B6-0/B6-6 Engines (12 each)
- 1788 ½ A3-4T Engines (24)
- 1789 C6-5 Engines (24)
- 1672 Blast-Off Flight Pack (6 each of A8-3, B6-4, C6-3 & C6-5)

LAUNCH EQUIPMENT

For first time flights you'll need launch equipment, which can be re-used launch after launch. We recommend choosing a Launch Set, as shown on pages 20-25 of this catalog. With each Launch Set you get the Launch Controller, Launch Pad, plus a rocket for the teacher.

USEFUL CLASSROOM TOOLS

- | | | | |
|------|-----------------------------|-----------|-----------------------------|
| 2227 | Tube Marking Guide | 2246 | Altimeter |
| 2228 | Ultimate Tube Marking Guide | 2315 | Tube Cutting Guides |
| 2231 | Fin Alignment Guide | 2290-2292 | Model Rocket Display Stands |
| 2232 | AltiTrak™ Altitude Finder | | |

1980 Designer's Special



Comes with everything you see here. Build and fly your own designs. 100+ parts to build up to 8 rockets. Turn your imagination into reality. Color of product may vary.

8311 ZipDisc™ Sports Set

Disc glides on a cushion of air, indoors and out. Includes: disc, 2 hockey sticks and 2 goals.



BALSA GLIDERS

3430 Tuff Birds Stratosphere™
Rubber Band Power
Length: 11 in (27.9 cm)
Wingspan: 12.8 in (32.5 cm)

3520 Tuff Birds Estes™
Length: 8.8 in (22.4 cm)
Wingspan: 9 in (22.9 cm)

FOAM GLIDERS

4014 Hydra™, Condor™ and Hothead™
Rubber Band Power
Length: 12 in (30.5 cm)
Wingspan: 13.5 in (34.3 cm)

4018 Wind Seeker™ Glider
Rubber band powered airplane
Length: 19.7 in (50 cm)
Wingspan: 16.2 in (41.1 cm)

MISCELLANEOUS

4024 Spin Factor™
Rubber band powered,
handheld helicopter



Color of product may vary.

RADIO CONTROL



4608 Mad Cat™

Fully Assembled!
 Length: 8.6 in (21.9 cm)
 Width: 1.4 in (3.6 cm)
 Height: 3.9 in (9.9 cm)
 For indoor flight only. Includes 3.7V Lithium Polymer Battery, 3.5 Channel Infrared Controller requires 6 - 1.5V AA alkaline batteries, not included. Recommended for ages 14+.

4603 Copperhead™

Length: 14.5 in (36.8 cm)
 Width: 2.5 in (6.4 cm)
 Height: 5.8 in (14.7 cm)
 Main Rotor: 11.8 in (30 cm)
 Includes fully assembled helicopter, Radio Controller, Rechargeable 3.7V Li-Po - 500mAh battery, AC Wall Charger, extra blades and instructions. Recommended for ages 14+.



4604 Diamondback™

Length: 24 in (61 cm)
 Width: 3.8 in (9.6 cm)
 Height: 8.8 in (22.6 cm)
 Main Rotor: 18 in (45.7 cm)
 Includes fully assembled helicopter, Radio Controller, Rechargeable 7.4V, 1000mAh battery, AC Wall Charger, extra blades and instructions. Recommended for ages 14+.



4609 Syncro™ Quadcopter

World's smallest quadcopter!
 2.4 GHz controller allows you to fly with your friends. Bright LED lights for flying in the low light conditions. Designed for great indoor flights. Includes USB charge cord for quick recharging. Requires 2 "AAA" batteries, not includeController. Recommended for ages 14+.

4610 Syncro™ Quadcopter

Easy to Fly!
 2.4 GHz controller allows you to fly with your friends. Bright LED lights for flying in the low light conditions. Designed for great indoor flights. Includes USB charge cord for quick recharging. Requires 2 "AAA" batteries, not includeController. Recommended for ages 14+.



4810 Kodo™ Quadcopter

Shoots crisp photos and videos!
 Length: 3.5 in (9 cm)
 Width: 3.5 in (9 cm)
 Weight: 1.8 oz (52 g)
 Integrated digital micro camera with 2G memory card and card reader. Indoor and outdoor flights. Includes 3.7V Lithium Polymer Battery, 2.4GHz radio Controller. Recommended for ages 14+.



4811 Ominous™ Quadcopter

Easy to fly indoors or outdoors!
 Length: 9.4 in (23.8 cm)
 Width: 9.4 in (23.8 cm)
 Weight: 3.6 oz (101 g)
 2-channel radio with flight mode LED Indicator, flip button, throttle/rudder stick on left and aileron/elevator stick on right. LED lights for easy day or night tracking. Four flight modes, Easy, Normal, Advanced, Expert. Recommended for ages 14+.

Color of product may vary.

RADIO CONTROL



9414

COMING SOON!

BLURZZ

ROCKET POWERED DRAGSTERS



Color of product may vary.



estesrockets.com