



Flying Model  
Rocket Catalog



*Featuring:*

The Historic  
**50<sup>th</sup>**  
Anniversary  
of the  
SATURN V



ALDO SPADONI © 2017



# Welcome to the exciting world of model rocketry...



| TABLE OF CONTENTS                                |    |
|--|----|
| Model Rocket Basics . . . . .                    | 5  |
| Get Started with Launch Sets . . . . .           | 10 |
| Easy to Build Beginner Rockets . . . . .         | 18 |
| Challenge Yourself A Little More! . . . . .      | 25 |
| Egg Launchers & Bertha Series . . . . .          | 32 |
| Multi-Stage Rockets . . . . .                    | 36 |
| Fun Recovery Rockets . . . . .                   | 42 |
| Imagine New Worlds with Space Voyagers . . . . . | 46 |
| Scale Model Rockets . . . . .                    | 50 |
| Saturn V Series Scale Model Rockets . . . . .    | 58 |
| Fly Big with Advanced Rockets . . . . .          | 60 |
| Pro Series II . . . . .                          | 62 |
| Model Rocket Engine Performance Chart . . . . .  | 66 |
| Engine Time/Thrust Curves . . . . .              | 69 |
| Model Rocket Accessories . . . . .               | 70 |
| Altitude Tracking . . . . .                      | 76 |
| Estes Education . . . . .                        | 82 |
| Bulk Packs for Education . . . . .               | 84 |
| Lifetime Launch System . . . . .                 | 90 |
| Phantom Classroom Demonstrator Rocket . . . . .  | 92 |
| Rocket Science Starter Set . . . . .             | 94 |
| Model Rocket Safety Code . . . . .               | 96 |
| Index . . . . .                                  | 98 |



... now this *is* rocket science!

**There is no thrill** quite like launching a model rocket you have built, watching it streak skyward, reaching apogee, then gently returning to earth on its parachute. In a very real sense, model rocketeers experience the same excitement felt by America's space scientists and astronauts as they push humankind's horizons relentlessly forward to the stars. The best way to get started is with an Estes launch set (see pages 10-17). Each launch set has nearly everything you need to build and fly your first rocket.

As you increase your rocketry skills, you can progress to new and exciting projects including multi-stage rockets, payload experiments and scale models. Whether you are a hobby beginner or expert, Estes Industries will help you advance higher, further and faster in your adventures.

Estes Industries encourages membership in the National Association of Rocketry for the active model rocketry enthusiast.







**Hello!**  
From Penrose, Colo.

**Our Vision:**

To be the best model rocket company on the planet...

**Our Mission:**

To work relentlessly to create exceptional customer experiences. Everything we do is designed to ignite passion for creativity, exploration, and innovation.

**Our Values:**

**Our safety record:**

60 years and over 500 million launches.

**Our uniqueness**

In a growing digital world, little compares to the experience of building and launching a model rocket.

**Our desire to teach:**

We recognize the value of model rocketry as an educational tool.

**Our employees:**

Many of our current employees have been on this journey with us for decades!

**Welcome to Estes Industries and the Exciting World of Model Rocketry!**

Since its creation by Vern and Gleda Estes 61 years ago, our company has made possible over 500 million rocket launches – with an amazing safety record.

**What is a Flying Model Rocket?**

Estes flying model rockets are activity kits designed of lightweight materials such as paper tubing, balsa wood and plastic. Fins attached to the body tube help provide guidance and stability. An engine mount assembly holds the engine in place during rocket flight in most models.



**Vern and Gleda Estes, the founders of Estes Rockets.**

**Flight Sequence and Model Rocket Parts**

**How Does a Model Rocket Work?**

The Estes model rocket is propelled into the air by an electrically ignited model rocket engine. After its acceleration, the rocket continues upward emitting tracking smoke as it coasts. At the rocket's peak altitude (also called apogee), a recovery device, such as a parachute or streamer, is deployed to return the rocket gently to earth. The rocket can then be prepared for another flight.

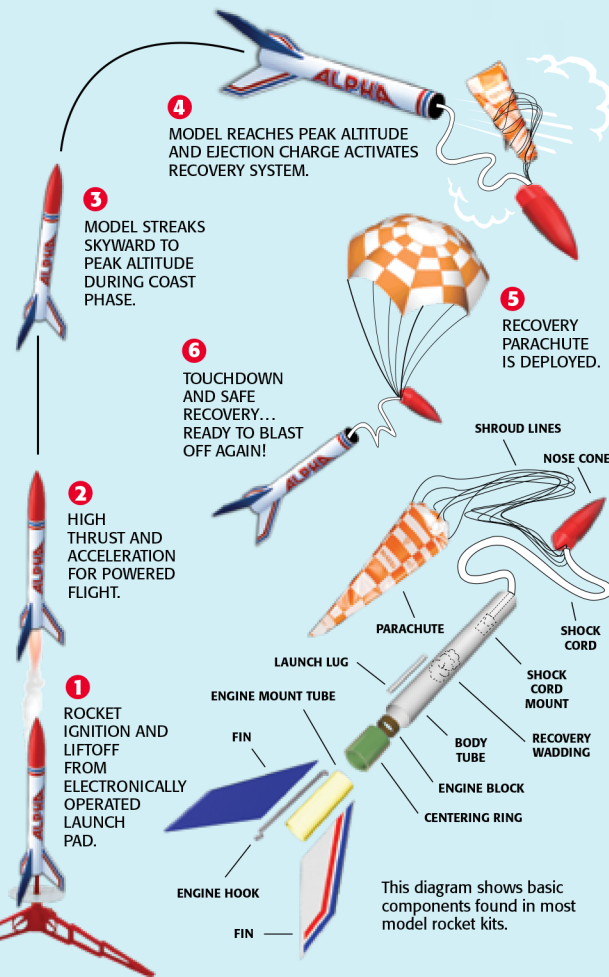

Estes model rocketry is recommended for ages 10 and up with adult supervision for those under 12.

This diagram shows basic components found in most model rocket kits.



## What is a Model Rocket Engine?

Estes model rocket engines are used to thrust a model rocket into the air. They are factory-assembled and comply with the code requirements of the National Association of Rocketry. They are single use and range in power from A to F sizes. The engine is started using an electrical launch system that is powered by alkaline batteries.

### Components of a Model Rocket Engine

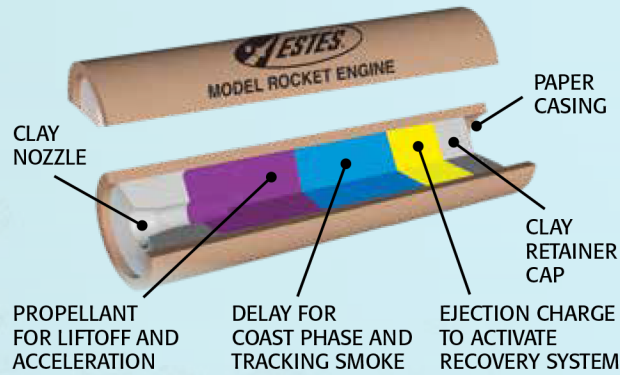

## How to prepare your rocket engine for launch:

- 1 Use the plug to secure the starter into the nozzle of your rocket engine.

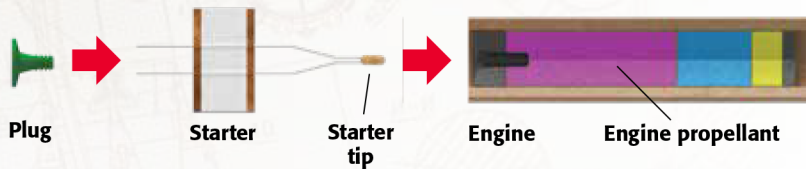

- 2 Make sure the starter is inserted into the engine nozzle and touches the propellant, then insert plug.

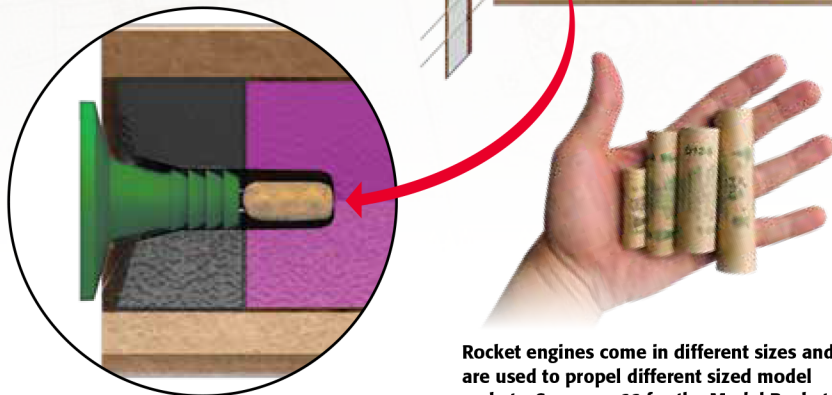

Rocket engines come in different sizes and are used to propel different sized model rockets. See page 66 for the Model Rocket Engine Performance Chart.

## Different Engine Phases

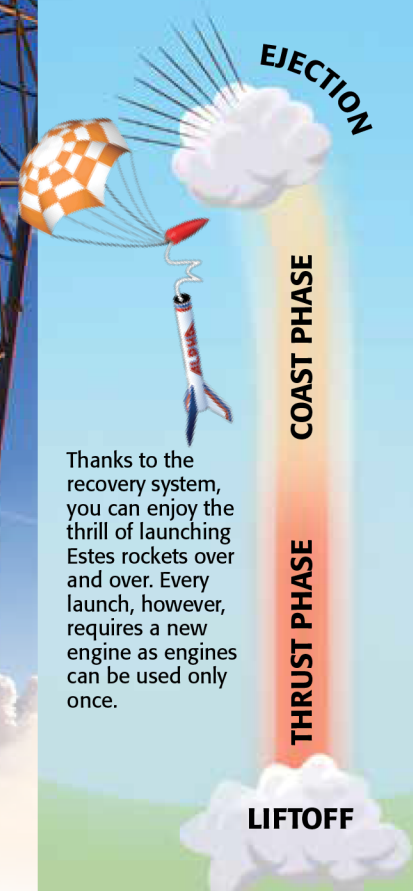

Thanks to the recovery system, you can enjoy the thrill of launching Estes rockets over and over. Every launch, however, requires a new engine as engines can be used only once.



Penrose,  
we have  
**Liftoff!**

## How Does a Model Rocket Engine Work?

- 1 When the engine is started, it produces thrust and boosts the rocket into the sky.
- 2 After the propellant is used up, the delay is activated, producing tracking smoke and allowing the rocket to coast.
- 3 After the delay is used, the ejection charge is activated, which deploys the recovery system, such as a parachute or streamer.

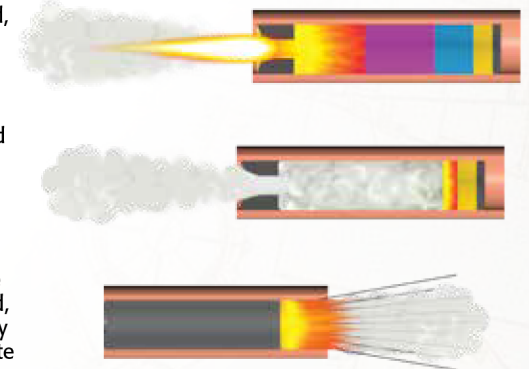



## Where to Launch Model Rockets

The chart below tells you what size field to use for each size engine. For launch information, look at the "NAR Model Rocket Safety Code" (page 96). You should always check with your local city government for any special regulations that may apply to your area. Generally speaking, you can fly most Estes model rockets in a clear area the size of a football field or soccer field. Launch in little or no wind, and make sure there is no dry grass close to the launch pad or in the flying field. Each engine size is designated by a letter and is up to twice as powerful as the letter before it. See the engine section (pages 66-67) of this catalog for more information.



### Launch Site Dimensions

| Installed Total Impulse (N-sec) | Equivalent Motor Type | Minimum Site Dimensions (ft.) |
|---------------------------------|-----------------------|-------------------------------|
| 0.00 - 1.25                     | 1/4A, 1/2A            | 50                            |
| 1.26 - 2.50                     | A                     | 100                           |
| 251 - 5.00                      | B                     | 200                           |
| 5.01 - 10.00                    | C                     | 400                           |
| 10.01 - 20.00                   | D                     | 500                           |
| 20.01 - 40.00                   | E                     | 1000                          |
| 40.01 - 80.00                   | F                     | 1000                          |

## Recommended Launch Area

Minimum launch site dimension for circular area is diameter in feet, and for rectangular area is shortest side in feet.

- Choose a large field away from power lines, buildings, tall trees and low flying aircraft. The larger the launch area, the better your chance of recovering your rocket. Football fields, parks and playgrounds are great. This diagram shows the smallest recommended launch areas.

Size of an American football field.

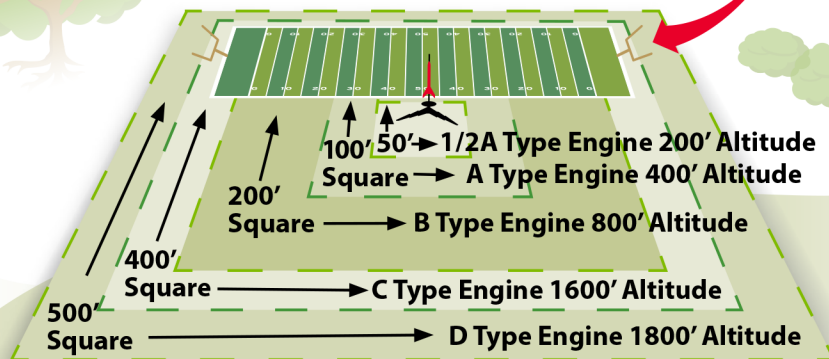

- Make sure the launch area is free of obstructions, dry weeds, brown grass or highly flammable materials.
- Launch only during calm weather with little or no wind and good visibility.

## Where to Find Details about a Rocket Kit in the Catalog

You'll find detailed information about each rocket in it's description:

- Measurements: length, diameter and estimated weight
- Special features
- Recovery system: parachute, streamer, tumble, spin, glide, featherweight, and break-apart
- Projected altitudes: estimates only
- Recommended engines
- Building classification

### Example of a Rocket Kit Description

#### 2160 HiJinks™

- Length: 14.5 in. (36.8 cm)
- Diameter: 0.98 in. (25 mm)
- Estimated Weight: 1.5 oz. (43 g)
- Fins: Plastic
- Recovery: Parachute
- Projected Altitude: 1100 ft. (335 m)
- Recommended Engines: A8-3 for first launch; B4-4, B6-4, C6-5, C6-7



The HiJinks is a Beginner model rocket.

## Building Classifications

All model rocket kits in this catalog require assembly unless otherwise indicated. Building classifications are designated by a letter given to each kit.

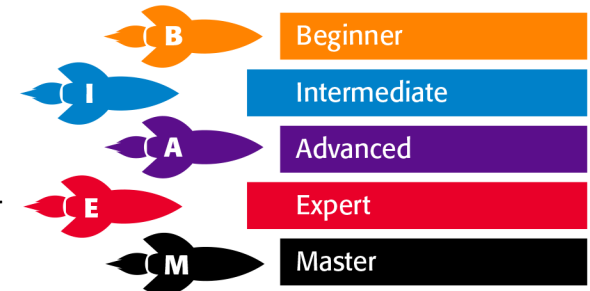

## Get started with an Estes launch set

The easiest entry point into the fun and exciting world of Estes model rocketry is to purchase an Estes launch set. Each launch set contains a rocket (or two) and a complete, high tech Estes launch system. In addition to the fun of building, launching and recovering of your own model rocket, Estes flying model rockets have significant STEM educational value. STEM stands for Science, Technology, Engineering and Math, and model rocketry utilizes all four disciplines. So rocketeers often become scientists and engineers.



### Example of an Estes Launch Set

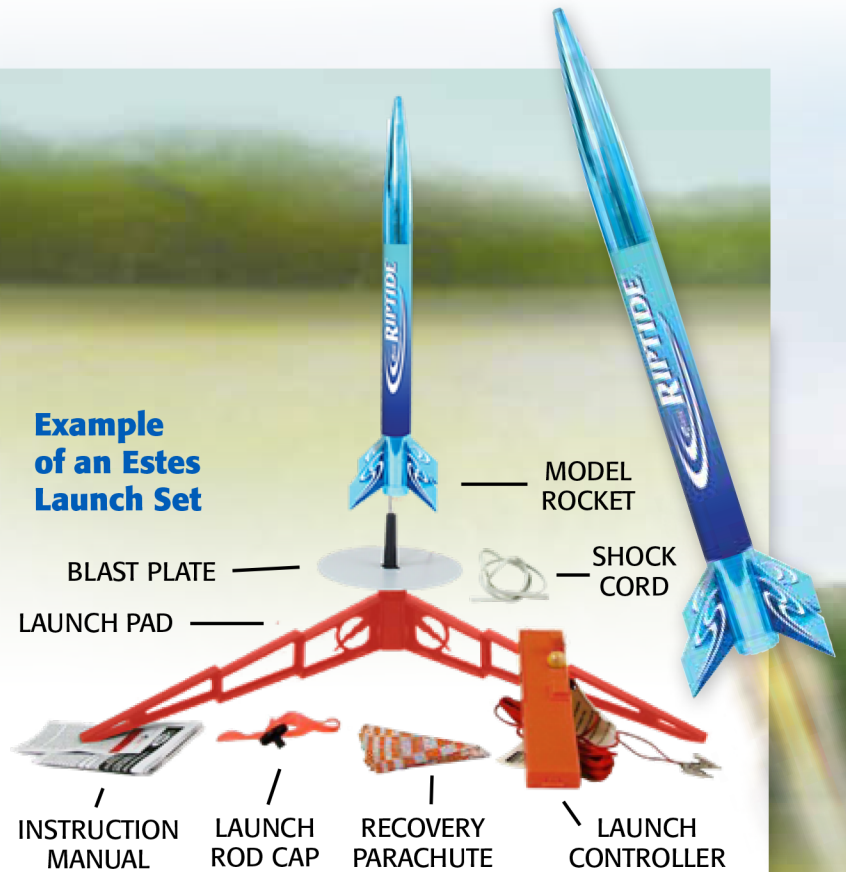

### Here's what's in the box:

One or two Estes model rockets (either in kit form or almost ready to fly), one each Estes Electron Beam® Launch Controller and Estes Porta Pad® II Launch Pad and instructions for assembly and use.

### Here's what's not in the box:

Recommended model rocket engines, starters and recovery wadding, tools, construction and finishing supplies for the rockets, and 4 new AA 1.5V alkaline batteries for the launch controller – sold separately.

Estes model rocketry is recommended for ages 10 and up with adult supervision for those under 12.



**WARNING:** Drilling, sawing, sanding or machining wood products can expose you to wood dust, a substance known to the State of California to cause cancer. Avoid inhaling wood dust or use a dust mask or other safeguards for personal protection. For more information go to [www.P65Warnings.ca.gov/wood](http://www.P65Warnings.ca.gov/wood)

All Estes rockets that contain wood parts/components carry this warning.



*Start your Estes experience here!*

**The best way to start is with one of our launch sets.**

**1427 Alpha III® Launch Set**

Length: 12.1 in. (30.7 cm)  
 Diameter: 0.98 in. (25 mm)  
 Estimated Weight: 1.2 oz. (34 g)  
 Fins: Plastic  
 Projected Altitude: 1150 ft. (351 m)  
 Recovery: 12 in. (30.5 cm)  
 Parachute  
 Recommended Engines:  
 A8-3 for first launch; 1/2A6-2,  
 A8-5, B4-4, B6-4, B6-6, C6-5, C6-7

**\$35.99**



**The Alpha III & Taser launch sets are Estes best sellers!**



**1491 Taser™ Launch Set**

Length: 17 in. (43.2 cm)  
 Diameter: 0.98 in. (25 mm)  
 Estimated Weight: 1.5 oz. (42.5 g)  
 Fins: Plastic  
 Recovery: 12 in. (30.5 cm) Parachute  
 Projected Altitude: 1100 ft. (335 m)  
 Recommended Engines: A8-3 for first launch; B4-4, B6-4, B6-6, C6-5, C6-7

**\$28.99**



**1469 Tandem-X™ Launch Set**  
**\$35.99**

**Crossfire ISX™**  
 Length: 15.6 in. (39.6 cm)  
 Diameter: 0.98 in. (25 mm)  
 Estimated Weight: 1.3 oz. (37 g)  
 Fins: Laser cut wood  
 Recovery: 12 in. (30.5 cm) Parachute  
 Projected Altitude: 1150 ft. (351 m)  
 Recommended Engines:  
 A8-3 for first launch; B4-4, B6-4, C6-5, C6-7



**Some launch sets, like the Tandem-X, come equipped with two rockets!**



**Amazon™**

Length: 29.4 in. (74.7 cm)  
 Diameter: 1.33 in. (34 mm)  
 Estimated Weight: 3 oz. (85 g)  
 Fins: Plastic  
 Recovery:  
 18 in. (45.7 cm) Parachute  
 Projected Altitude: 600 ft. (183 m)  
 Recommended Engines: B4-2 for first launch; B4-4, B6-2, B6-4, C6-3, C6-5



The Whirlybird nose cone returns to earth via helicopter blades upon ejection.



**1446 Whirlybird™ Launch Set**

Length: 21.2 in. (53.8 cm)  
 Diameter: 1.35 in. (34 mm)  
 Estimated Weight: 2.9 oz. (82.2 g)  
 Fins: Plastic  
 Projected Altitude: 650 ft. (198 m)  
 Recovery: 12 in. (30.5 cm) Parachute; Nose Cone - Spin  
 Recommended Engines: C6-5  
**\$29.99**



**1478 Flash!™ Launch Set**

Length: 16.2 in. (41.1 cm)  
 Diameter: 1.1 in. (28 mm)  
 Estimated Weight: 1.8 oz. (52 g)  
 Recovery: 12 in. (30.5 cm) Parachute  
 Fins: Plastic  
 Projected Altitude: 925 ft. (282 m)  
 Recommended Engines: A8-3 for first launch; B4-4, B6-4, C6-5, C6-7  
**\$28.99**



The Zombie body tube comes with cool creepy art!



**1435 Zombie™ Launch Set**

Length: 19 in. (48.3 cm)  
 Diameter: 0.98 in. (25 mm)  
 Estimated Weight: 1.7 oz. (48.2 g)  
 Fins: Plastic  
 Projected Altitude: 1100 ft. (335 m)  
 Recovery: 12 in. (30.5 cm) Parachute  
 Recommended Engines: A8-3 for first launch; B4-4, B6-4, C6-5, C6-7  
**\$24.99**



**1436 Javelin™ Launch Set**

Length: 15 in. (38 cm)  
 Diameter: 0.98 in. (25 mm)  
 Estimated Weight: 1.3 oz. (36.9 g)  
 Fins: Plastic  
 Projected Altitude: 600 ft. (183 m)  
 Recovery: 12 in. (30.5 cm) Parachute, glide  
 Recommended Engines: A8-3 for first launch; B4-4, B6-4  
**\$29.99**



A lightweight glider separates from the Javelin and then glides softly to the ground.



The Flicker nose cone lights up with different colors ranging from yellow to blue to red!

**1437 Flicker™ Launch Set**

LIGHTS, CAMERA, ACTION! Well almost. LIGHTS anyway! The Flicker is unique among Estes rockets in that the nose cone lights up with various colors and patterns! Bright LEDs light up the sky! Comes with a 15 inch parachute for ease of recovery. So come on, what are you waiting for? Get your Flicker today and let's light up the sky!  
 Length: 21 in. (53.3 cm)  
 Diameter: 1.33 in. (34 mm)  
 Estimated Weight: 3.2 oz. (90.7 g)  
 Nose Cone: LED lights  
 Fins: Plastic  
 Projected Altitude: 650 ft. (198 m)  
 Recovery: 15 in. (38.1 cm) Parachute  
 Recommended Engines: B6-4 for first launch; C6-5  
**\$29.99**





**1499 Rascal™ & HiJinks™ Launch Set**  
**\$35.99**

**Rascal™**  
 Length: 14.5 in. (36.8 cm)  
 Diameter: 0.98 in. (25 mm)  
 Estimated Weight: 1.5 oz. (43 g)  
 Fins: Plastic  
 Recovery: 12 in. (30.5 cm) Parachute  
 Projected Altitude: 1100 ft. (335 m)  
 Recommended Engines: A8-3 for first launch;  
 B4-4, B6-4, C6-5, C6-7

**The Rascal  
 & HiJinks  
 Launch Set  
 comes with two  
 preassembled  
 rockets!**



**1411 Journey™  
 Launch Set**  
 Length: 19.3 in. (49 cm)  
 Diameter: 0.98 in. (25 mm)  
 Estimated Weight: 1.8 oz. (51 g)  
 Fins: Plastic  
 Projected Altitude:  
 1100 ft. (335 m)  
 Recovery:  
 12 in. (30.5 cm) Parachute  
 Recommended Engines:  
 A8-3 for first launch; B4-4,  
 B6-4, C6-5, C6-7  
**\$32.99**



**1403 Riptide™ Launch Set**  
 Length: 18 in. (45.7 cm)  
 Diameter: 1.35 in. (34 mm)  
 Estimated Weight: 2.7 oz. (76.5 g)  
 Fins: Plastic  
 Recovery: 12 in. (30.5 cm) Parachute  
 Projected Altitude: 675 ft. (206 m)  
 Recommended Engines:  
 B4-4 for first launch; B6-4, C6-5  
**\$37.99**



**No  
 assembly  
 required!**



**This rocket  
 transforms!  
 The Wacky  
 Wiggler goes  
 up as a rocket  
 and...**

**... comes down  
 as a wiggly  
 segmented  
 recovery  
 device!**



**1413 Wacky Wiggler™  
 Launch Set**  
 Length: 17.6 in. (44.7 cm)  
 Diameter: 1.1 in. (28 mm)  
 Estimated Weight:  
 2.3 oz. (45.4 g)  
 Fins: Plastic  
 Recovery: Break-apart  
 Projected Altitude:  
 800 ft. (244 m)  
 Recommended Engines:  
 B6-4 for first launch; C6-5  
**\$29.99**



**HiJinks™**  
 Length: 14.5 in. (36.8 cm)  
 Diameter:  
 0.98 in. (25 mm)  
 Estimated Weight:  
 1.5 oz. (43 g)  
 Fins: Plastic  
 Recovery: 12 in. Parachute  
 Projected Altitude:  
 1100 ft. (335 m)  
 Recommended Engines:  
 A8-3 for first launch;  
 B4-4, B6-4, C6-5, C6-7



**1418 Flip Flyer™ Launch Set**  
 How could we make the amazing,  
 dual-recovery Estes Flip Flyer™ even  
 better? By packaging it with its own  
 launch pad and launch controller,  
 that's how!  
 Length: 19.2 in. (48.8 cm)  
 Diameter: 0.98 in. (25 mm)  
 Estimated Weight: 3.2 oz. (90.7 g)  
 Fins: Plastic  
 Recovery:  
 Rocket: Spin  
 Nose cone:  
 9 in. (23 cm) Parachute  
 Projected Altitude: 750 ft. (229 m)  
 Recommended Engines:  
 B6-4 for first launch; C6-5  
**\$29.99**



# Add to your fleet!

Our easiest to build and fly rockets.

## 1256 Alpha III®

The high-flying Alpha III® is another model rocketry classic! The iconic orange and black space model is easy to build and fun to fly!

Length: 12.1 in. (30.7 cm)

Diameter: 0.98 in. (25 mm)

Estimated Weight: 1.2 oz. (34 g)

Fins: Plastic

Recovery: 12 in. (30.5 cm) Parachute

Projected Altitude: 1150 ft. (351 m)

Recommended Engines:

A8-3 for first launch; 1/2A6-2, A8-5, B4-4, B6-4, B6-6, C6-5, C6-7

**\$21.99**



## 2008 Generic E2X®

Length: 13.5 in. (34.3 cm)

Diameter: 0.98 in. (25 mm)

Estimated Weight: 1.3 oz. (36.8 g)

Fins: Plastic

Recovery: 12 in. (30.5 cm)

Parachute

Projected Altitude:

1100 ft. (335 m)

Recommended Engines:

A8-3 for first launch; 1/2A6-2,

A8-5, B4-4, B6-4, B6-6, C6-5,

C6-7

**\$12.99**



## 2603 Sundancer™

Length: 16.5 in. (41.9 cm)

Diameter: 0.98 in. (25 mm)

Estimated Weight: 1.4 oz. (39.7 g)

Fins: Plastic

Recovery: 12 in. (30.5 cm) Parachute

Projected Altitude: 1100 ft. (335 m)

Recommended Engines:

A8-3 for first launch; B6-4, C6-5

**\$13.99**

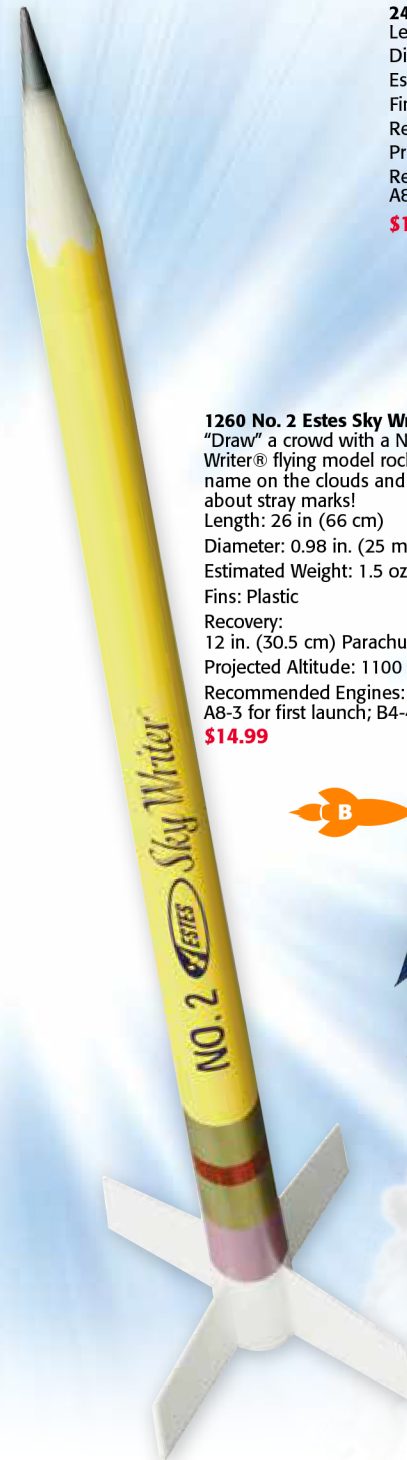

## 1260 No. 2 Estes Sky Writer®

"Draw" a crowd with a No. 2 Estes Sky Writer® flying model rocket. Sign your name on the clouds and never worry about stray marks!

Length: 26 in. (66 cm)

Diameter: 0.98 in. (25 mm)

Estimated Weight: 1.5 oz. (42.5 g)

Fins: Plastic

Recovery:

12 in. (30.5 cm) Parachute

Projected Altitude: 1100 ft. (335 m)

Recommended Engines:

A8-3 for first launch; B4-4, B6-4, C6-5

**\$14.99**



## 2452 Athena™

Length: 17 in. (43.2 cm)

Diameter: 0.98 in. (25 mm)

Estimated Weight: 1.4 oz. (39.7 g)

Fins: Plastic

Recovery: 12 in. (30.5 cm) Parachute

Projected Altitude: 1125 ft. (343 m)

Recommended Engines:

A8-3 for first launch; B6-4, C6-5

**\$13.99**



No assembly required!



## 2433 Zinger™

Length: 15 in. (38.1 cm)

Diameter: 0.74 in. (19 mm)

Estimated Weight: 0.9 oz. (25.5 g)

Fins: Plastic

Recovery: 6 in. (15.2 cm) Parachute

Projected Altitude: 500 ft. (152 m)

Recommended Engines: 1/2A3-4T for first launch;

A3-4T, A10-3T

**\$10.99**





**3**  
Rocket  
set!

**2435 3 Bandits™**  
3 rocket set  
Length: 10.8-11.1 in. (27.4-28.2 cm)  
Diameter: 0.74 in. (19 mm)  
Estimated Weight: .6-.71 oz. (17-20.1 g)  
Fins: Plastic  
Recovery: 6 in. (15.2 cm) Parachute  
Projected Altitude: 550 ft. (168 m)  
Recommended Engines: 1/2A3-4T for first launch; A3-4T, A10-3T  
**\$23.99**



**0804 Firehawk™**  
Length: 11.2 in. (28.4 cm)  
Diameter: 0.74 in. (19 mm)  
Estimated Weight: 0.65 oz. (18.4 g)  
Fins: Plastic  
Recovery:  
6 in. (15.2 cm) Parachute  
Projected Altitude: 550 ft. (168 m)  
Recommended Engines:  
1/4A3-3T for first launch;  
1/2A3-2T, A3-4T, A10-3T  
**\$10.99**



**2492 Spirit™**  
Length: 21 in. (53.3 cm)  
Diameter: 1.33 in. (34 mm)  
Estimated Weight: 3.1 oz. (87.9 g)  
Fins: Plastic  
Recovery:  
15 in. (38.1 cm) Parachute  
Projected Altitude: 600 ft. (183 m)  
Recommended Engines: B6-4 for first launch; B6-2, C6-3, C6-5  
**\$17.99**



**0806 Firestreak SST™**  
Length: 10.2 in. (25.9 cm)  
Diameter: 0.86 in. (22 mm)  
Estimated Weight: 1.1 oz. (31.2 g)  
Fins: Plastic  
Recovery: 12 in. (30.5 cm) Streamer  
Projected Altitude: 350 ft. (107 m)  
Recommended Engines: A3-4T for first launch;  
1/2A3-2T, 1/2A3-4T, A10-3T  
**\$10.99**



**2497 Nova™**  
Length: 20.6 in. (52.3 cm)  
Diameter: 1.33 in. (34 mm)  
Estimated Weight: 2.5 oz. (70.9 g)  
Fins: Plastic  
Recovery:  
15 in. (38.1 cm) Parachute  
Projected Altitude: 700 ft. (213 m)  
Recommended Engines:  
B6-4 for first launch; B6-2, C6-3, C6-5  
**\$21.99**



**2483 Phantom Blue™**  
Length: 19.4 in. (49.3 cm)  
Diameter: 0.98 in. (25 mm)  
Estimated Weight: 1.4 oz. (39.7 g)  
Fins: Plastic  
Recovery:  
12 in. (30.5 cm) Parachute  
Projected Altitude:  
1150 ft. (351 m)  
Recommended Engines:  
A8-3 for first launch; B4-4, B6-4,  
C6-5, C6-7  
**\$18.99**

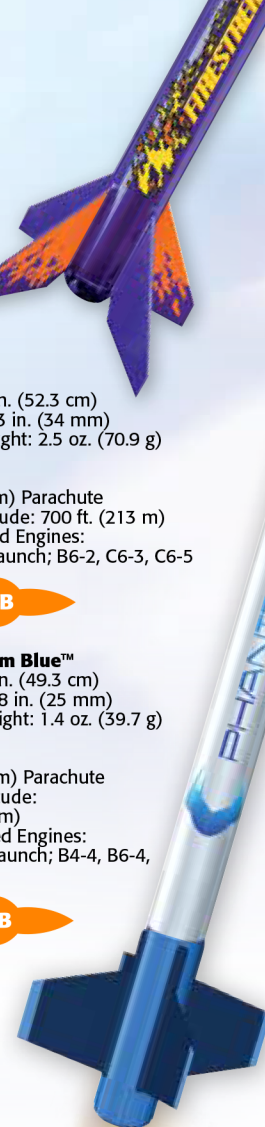

**2169 Dragonite™**  
Length: 16 in. (40.6 cm)  
Diameter: 1.1 in. (28 mm)  
Estimated Weight: 1.8 oz. (51 g)  
Fins: Plastic  
Recovery:  
12 in. (30.5 cm) Parachute  
Projected Altitude: 1125 ft. (343 m)  
Recommended Engines: A8-3 for first launch; B4-4, B6-4, C6-5, C6-7  
**\$16.99**





**Our highest-powered  
beginner rocket!**

**2466 Show Stopper™**

Length: 26.2 in. (66.5 cm)  
Diameter: 1.64 in. (42 mm)  
Estimated Weight: 4 oz. (113.4 g)  
Fins: Plastic  
Recovery: 15 in. (38.1 cm) Parachute  
Projected Altitude:  
875 ft. (267 m)  
Recommended Engines:  
C11-3 for first launch;  
C11-5, D12-5, D12-7  
**\$25.99**



**2490 Fractured™**

Length: 18 in. (45.7 cm)  
Diameter: 1.64 in. (42 mm)  
Estimated Weight: 3.7 oz. (104.9 g)  
Fins: Plastic  
Recovery:  
15 in. (38.1 cm) Parachute  
Projected Altitude:  
550 ft. (168 m)  
Recommended Engines:  
B6-2 for first launch; B4-2,  
C6-3, C6-5  
**\$16.99**



**0803 Bandito™**

Length: 11.2 in. (28.4 cm)  
Diameter: 0.74 in. (19 mm)  
Estimated Weight: 0.60 oz. (17 g)  
Fins: Plastic  
Recovery:  
12 in. (30.5 cm) Parachute  
Projected Altitude: 600 ft. (183 m)  
Recommended Engines:  
1/4A3-3T for first launch;  
1/2A3-2T, A3-4T, A10-3T  
**\$10.99**



**2494 Dazzler™**

Length: 17.5 in. (44.5 cm)  
Diameter: 0.98 in. (25 mm)  
Estimated Weight:  
1.5 oz. (30.5 g)  
Fins: Plastic  
Recovery:  
12 in. (30.5 cm) Parachute  
Projected Altitude:  
1125 ft. (343 m)  
Recommended Engines:  
A8-3 for first launch; B4-4,  
B6-4, C6-5, C6-7  
**\$16.99**



**2486 Flying Colors™**

Length: 21 in. (53.3 cm)  
Diameter:  
1.64 in. (42 mm)  
Estimated Weight:  
3 oz. (85 g)  
Fins: Plastic  
Recovery: 15 in. (38.1 cm) Parachute  
Projected Altitude: 550 ft. (186 m)  
Recommended Engines: B4-2 for first  
launch; B6-2, B6-4, C6-3, C6-5  
**\$16.99**



**7277 Galaxy Glow™**

Length: 19.6 in. (49.8 cm)  
Diameter: 0.98 in. (25 mm)  
Estimated Weight:  
1.6 oz. (45.4 g)  
Fins: Plastic  
Recovery:  
12 in. (30.5 cm) Parachute  
Projected Altitude:  
1100 ft. (335 m)  
Recommended Engines: A8-3  
for first launch; B4-4, B6-4,  
B6-6, C6-5, C6-7  
**\$14.99**



**2482 Solaris™**

Length: 18.5 in. (47 cm)  
Diameter: 0.98 in. (25 mm)  
Estimated Weight: 1.6 oz. (45.4 g)  
Fins: Plastic  
Recovery:  
12 in. (30.5 cm) Parachute  
Projected Altitude:  
1125 ft. (343 m)  
Recommended Engines: A8-3 for  
first launch; B4-4, B6-4, C6-5, C6-7  
**\$18.99**



**Shiny  
Chrome  
Finish**

**2495 Chiller™**

Length: 19.4 in. (49.3 cm)  
Diameter: 1.33 in. (34 mm)  
Estimated Weight: 2.7 oz. (76.5 g)  
Fins: Plastic  
Recovery:  
15 in. (38.1 cm) Parachute  
Projected Altitude:  
600 ft. (183 m)  
Recommended Engines:  
B6-4 for first launch; B4-2, B6-2,  
C6-3, C6-5  
**\$18.99**



**2481 Power Patrol™**

Length: 20.5 in. (52.1 cm)  
Diameter: 0.98 in. (25 mm)  
Estimated Weight: 1.6 oz. (45.4 g)  
Fins: Plastic  
Recovery:  
12 in. (30.5 cm) Parachute  
Projected Altitude: 1100 ft. (335 m)  
Recommended Engines: A8-3 for  
first launch; B4-4, B6-4, C6-5, C6-7

**\$18.99**

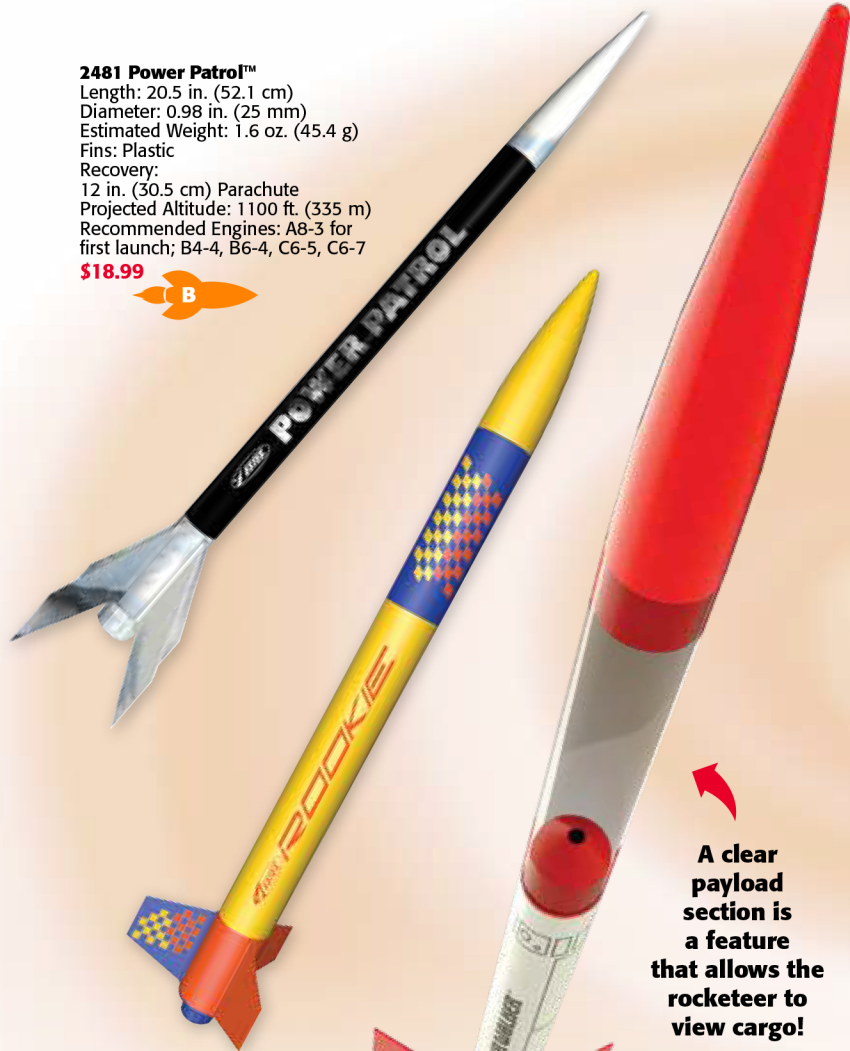

**A clear  
payload  
section is  
a feature  
that allows the  
rocketeer to  
view cargo!**

**2498 Rookie™**

Length: 23.3 in. (59.2 cm)  
Diameter: 1.64 in. (42 mm)  
Estimated Weight: 3.6 oz. (102 g)  
Fins: Plastic  
Recovery:  
15 in. (38.1 cm) Parachute  
Projected Altitude: 550 ft. (168 m)  
Recommended Engines:  
B6-2 for first launch; C6-3, C6-5

**\$16.99**



**7261 Air Walker™**

Length: 21.7 in. (55.1 cm)  
Diameter: 1.1 in. (28 mm)  
Estimated Weight: 2 oz. (56.7 g)  
Fins: Plastic  
Recovery:  
12 in. (30.5 cm) Parachute  
Projected Altitude: 950 ft. (290 m)  
Recommended Engines:  
B6-4 for first launch; B4-4, C6-5

**\$18.99**



*Challenge yourself  
a little more!*

**These rockets take  
more time to build.**

**1345 Mosquito™**

Length: 3.8 in. (9.6 cm)  
Diameter: 0.54 in. (14 mm)  
Estimated Weight:  
0.11 oz. (3.1 g)  
Fins: Laser cut wood  
Recovery: Featherweight  
Projected Altitude:  
800 ft. (244 m)  
Recommended Engines:  
1/4A3-3T for first launch;  
1/2A3-2T, 1/2A3-4T, A3-4T,  
A10-3T

**\$6.99**



**2178 Hi-Flier®**

Length: 12 in. (30.5 cm)  
Diameter: 0.74 in. (19 mm)  
Estimated Weight: .9 oz. (25.5 g)  
Fins: Laser cut wood  
Recovery: 12 in. (30.5) Streamer  
Projected Altitude:  
1500 ft. (457 m)  
Recommended Engines:  
A8-3 for first launch; 1/2A6-2,  
A8-5, B4-4, B6-4, B6-6, C6-5,  
C6-7

**\$11.99**



**1225 Alpha®**

Length: 12.3 in. (31.2 cm)  
Diameter: 0.98 in. (25 mm)  
Estimated Weight: 0.8 oz. (22.7 g)  
Fins: Laser cut wood  
Recovery:  
12 in. (30.5 cm) Parachute  
Projected Altitude: 1000 ft. (305 m)  
Recommended Engines: A8-3 for  
first launch; 1/2A6-2, A8-5, B4-4,  
B6-4, B6-6, C6-5, C6-7

**\$18.99**



**3031 Star Trooper™**

Length: 7 in. (17.8 cm)  
Diameter: 0.54 in. (14 mm)  
Estimated Weight: 0.3 oz. (8.5 g)  
Fins: Laser cut wood  
Recovery: 6 in. (15.2 cm) Streamer  
Projected Altitude: 900 ft. (274 m)  
Recommended Engines: 1/2A3-4T for  
first launch; 1/4A3-3T, A3-4T, A10-3T

**\$6.99**





### Swift flight sequence

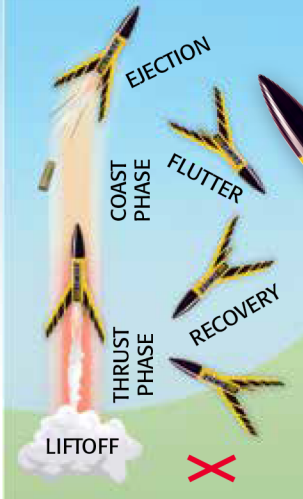

The Swift is lightweight and gently flutters to the ground without a parachute. During the ejection phase, the engine pops out. Insert another and you're ready to launch again!

### 0810 220 Swift™

Length: 4.5 in. (11.4 cm)  
Diameter: 0.54 in. (14 mm)  
Estimated Weight: .09 oz. (2.5 g)  
Fins: Laser cut wood  
Recovery: Featherweight  
Projected Altitude: 850 ft. (259 m)  
Recommended Engines:  
1/4A3-3T for first launch; 1/2A3-2T,  
1/2A3-4T, A3-4T, A10-3T

**\$9.99**



### 7220 7220 Crossfire ISX™

Length:  
15.6 in. (39.6 cm)  
Diameter: 0.98 in. (25 mm)  
Estimated Weight:  
1.3 oz. (37 g)  
Fins: Laser cut wood  
Recovery:  
12 in. (30.5 cm) Parachute  
Projected Altitude:  
1150 ft. (351 m)  
Recommended Engines:  
A8-3 for first launch;  
B4-4, B6-4, C6-5, C6-7

**\$13.99**



### 1381 Yankee™

Length: 11 in. (27.9 cm)  
Diameter: 0.74 in. (19 mm)  
Estimated Weight: 0.4 oz. (12 g)  
Fins: Laser cut wood  
Recovery: 18 in. (45.7 cm) Streamer  
Projected Altitude: 1700 ft. (518 m)  
Recommended Engines:  
A8-3 for first launch; 1/2A6-2, A8-5,  
B4-4, B6-4, B6-6, C6-5, C6-7

**\$13.99**



### 1292 Wizard™

Length: 12 in. (30.5 cm)  
Diameter: 0.74 in. (19 mm)  
Estimated Weight: 0.5 oz. (14.2 g)  
Fins: Laser cut wood  
Recovery: 18 in. (45.7 cm) Streamer  
Projected Altitude: 1600 ft. (488 m)  
Recommended Engines:  
A8-3 for first launch; 1/2A6-2, A8-5,  
B4-4, B6-4, B6-6, C6-5, C6-7

**\$13.99**



### The Viking has 48 various fin configurations to choose from:

It's up to you to decide how to build the Estes Viking! How many fins? Where to place them? It's your choice to create the rocket YOU want!

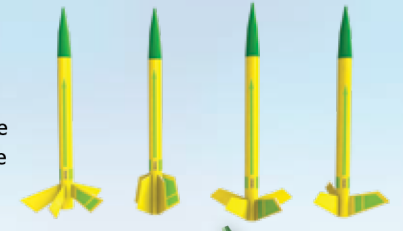

### 1949 Viking™

Length: 12.1 in. (30.7 cm)  
Diameter: 0.74 in. (19 mm)  
Estimated Weight: 0.6 oz. (17 g)  
Fins: Cardstock  
Recovery: 18 in. (45.7 cm) Streamer  
Projected Altitude: 1600 ft. (488 m)  
Recommended Engines: A8-3 for first launch;  
1/2A6-2, A8-5, B4-4, B6-4, B6-6, C6-5, C6-7

**\$13.99**



### 0651 Der Red Max™

Length: 16.3 in. (41.4 cm)  
Diameter: 1.64 in. (42 mm)  
Estimated Weight: 2.4 oz. (68 g)  
Fins: Laser cut wood  
Recovery: 18 in. (45.7 cm) Parachute  
Projected Altitude: 600 ft. (183 m)  
Recommended Engines:  
B6-2 for first launch; B4-2, B4-4, B6-4, C6-5

**\$19.99**



### Hex-3 flight sequence

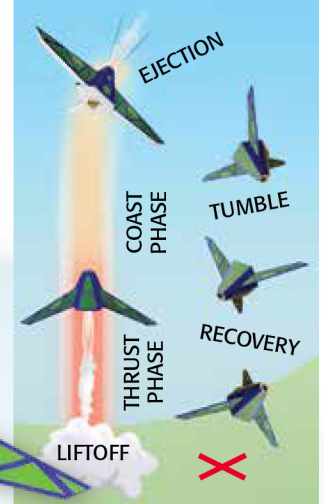

The Hex-3 is constructed with cardstock which makes for a lightweight tumble recovery that requires no parachute. Enjoy launching it over and over again!

### 7263 Hex-3™

Length: 3.2 in. (8.1 cm)  
Diameter: Hub: 3.8 in. (9.6 cm)  
Overall Diameter: 11.5 in. (29.2 cm)  
Estimated Weight: 0.6 oz. (17 g)  
Fins: Printed cardstock  
Recovery: Tumble  
Projected Altitude: 100 ft. (30 m)  
Recommended Engines: B6-0  
for first launch; C6-0

**\$8.99**





**The Space Twister fin configuration allows it to spin as it goes up.**

**7258 Space Twister™**

Length: 24.7 in. (62.7 cm)  
Diameter: 0.98 in. (25 mm)  
Estimated Weight: 1.5 oz. (42.5 g)  
Fins: Laser cut wood  
Recovery: 12 in. (30.5 cm) Parachute  
Projected Altitude: 900 ft. (274 m)  
Recommended Engines: A8-3 for first launch; B6-4, C6-5

**\$17.99**



**0652 Citation Patriot™**  
Length: 25.6 in. (65 cm)  
Diameter: 1.64 in. (42 mm)  
Estimated Weight: 3.2 oz. (90.7 g)  
Fins: Laser cut wood  
Recovery: 12 in. (30.5 cm) Parachute  
Projected Altitude: 600 ft. (183 m)  
Recommended Engines: B4-2 for first launch; B6-4, C6-5

**\$26.99**



**Originally released in 1972, the Citation Patriot is a true Estes classic!**



**7244 Indicator™**

Length: 21.2 in. (53.8 cm)  
Diameter: Top 0.74 in. (19 mm)  
Bottom 0.98 in. (25 mm)  
Estimated Weight: 1.3 oz. (36.9 g)  
Fins: Laser cut wood  
Recovery: 9 in. (22.9 cm) Parachute  
Projected Altitude: 200 ft. (61 m)  
Recommended Engines: A3-4T for first launch; A10-3T

**\$16.99**



**7238 Sequoia™**

Length: 20 in. (50.8 cm)  
Diameter: 0.74 in. (19 mm)  
Estimated Weight: 1.1 oz. (31.2 g)  
Fins: Laser cut wood  
Recovery: 9 in. (22.9 cm) Parachute  
Projected Altitude: 350 ft. (107 m)  
Recommended Engines: A3-4T for first launch; A10-3T

**\$14.99**



**7242 Super Neon™**

Length: 22.3 in. (56.6 cm)  
Diameter: 0.98 in. (25 mm)  
Estimated Weight: 1.9 oz. (53.9 g)  
Fins: Laser cut wood  
Recovery: 12 in. (30.5 cm) Parachute  
Projected Altitude: 1000 ft. (305 m)  
Recommended Engines: A8-3 for first launch; B4-4, B6-4, C6-5

**\$19.99**



**2442 Mini Fat Boy™**

Length: 8.5 in. (21.6 cm)  
Diameter: 1.64 in. (42 mm)  
Estimated Weight: 1.3 oz. (36.8 g)  
Fins: Laser cut wood  
Recovery: 12 in. (30.5 cm) Parachute  
Projected Altitude: 250 ft. (76 m)  
Recommended Engines: A10-3T

**\$13.99**



**7237 Goblin™**

Length: 14.4 in. (36.6 cm)  
Diameter: 1.33 in. (34 mm)  
Estimated Weight: 2.5 oz. (70.9 g)  
Fins: Laser cut wood  
Recovery: 2x 36 in. (91.3 cm) Streamers  
Projected Altitude: 1400 ft. (427 m)  
Recommended Engines: D12-5 for first launch; C11-3, C11-5, D12-7

**\$19.99**





### 7239 Sky Warrior™

Length: 19 in. (48.3 cm)  
 Diameter: 1.33 in. (34 mm)  
 Estimated Weight: 1.9 oz. (53.9 g)  
 Fins: Laser cut wood  
 Recovery: 12 in. (30.5 cm) Parachute  
 Projected Altitude: 850 ft. (259 m)  
 Recommended Engines: B6-4 for first launch; C6-5

**\$20.99**



### 3232 Centuri®

Length: 29.3 in. (74.4 cm)  
 Diameter: 1.33 in. (34 mm)  
 Estimated Weight: 3.1 oz. (87.9 g)  
 Fins: Laser cut wood  
 Recovery: 12 in. (30.5 cm) Parachute  
 Projected Altitude: 600 ft. (183 m)  
 Recommended Engines: B4-4 for first launch; B6-4, C6-5

**\$21.99**



### 7234 Crossbow SST™

Length: 15 in. (38.1 cm)  
 Diameter: 0.74 in. (19 mm)  
 Estimated Weight: 1.1 oz. (31.2 g)  
 Fins: Laser cut wood  
 Recovery: 12 in. (30.5 cm) Parachute  
 Projected Altitude: 1600 ft. (488 m)  
 Recommended Engines: A8-3 for first launch; B6-4, C6-5

**\$15.99**



### 1295 Mean Machine™

Length: 79 in. (200.7 cm)  
 Diameter: 1.64 in. (42 mm)  
 Estimated Weight: 8.5 oz. (241 g)  
 Fins: Laser cut wood  
 Recovery: 24 in. (61 cm) Parachute  
 Projected Altitude: 700 ft. (213 m)  
 Recommended Engines: D12-3 for first launch; D12-5, E12-4, E12-6  
 Requires 3/16 in. (5 mm) Maxi™ Launch Rod PN 2244; sold separately

**\$32.99**

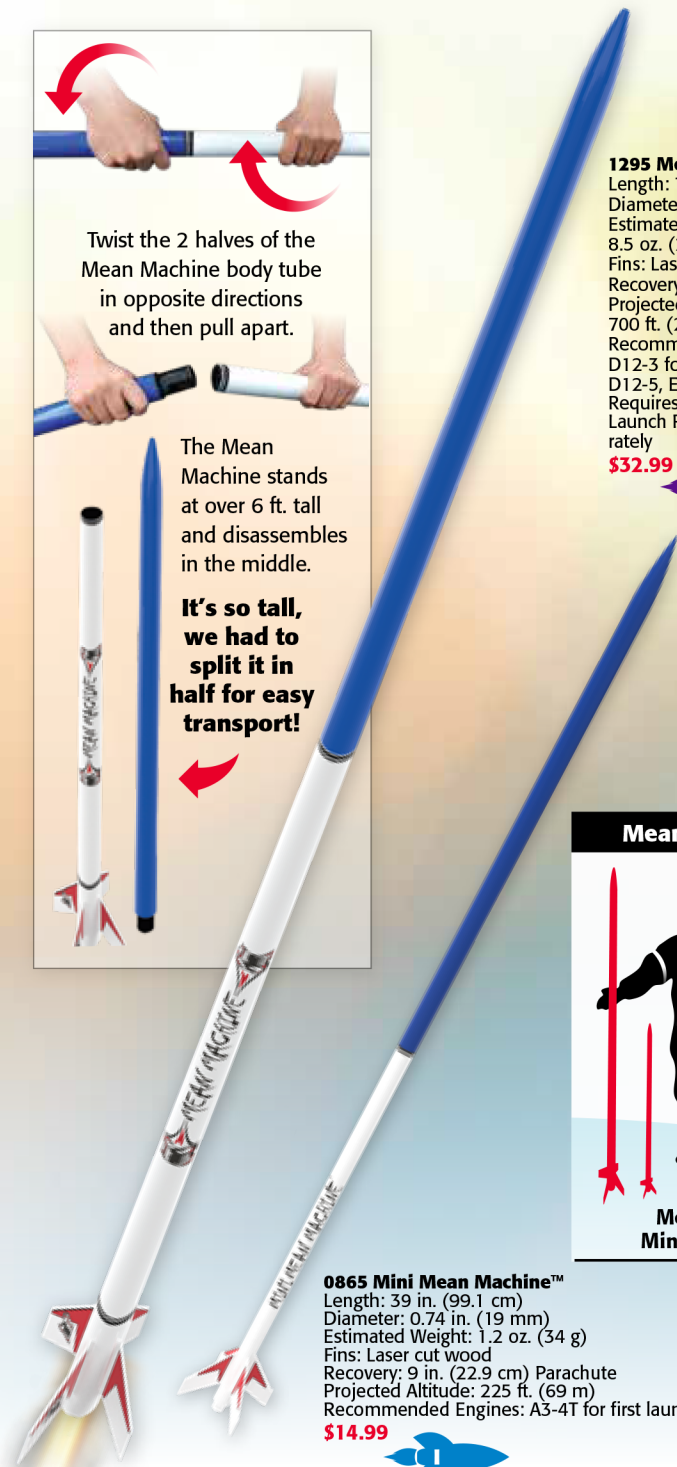

### Mean Machine Sizes

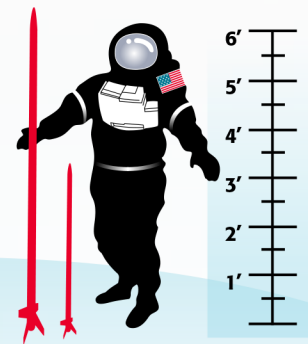

Mean Machine & Mini Mean Machine

### 0865 Mini Mean Machine™

Length: 39 in. (99.1 cm)  
 Diameter: 0.74 in. (19 mm)  
 Estimated Weight: 1.2 oz. (34 g)  
 Fins: Laser cut wood  
 Recovery: 9 in. (22.9 cm) Parachute  
 Projected Altitude: 225 ft. (69 m)  
 Recommended Engines: A3-4T for first launch; A10-3T

**\$14.99**





**Hurl an egg at the high heavens**

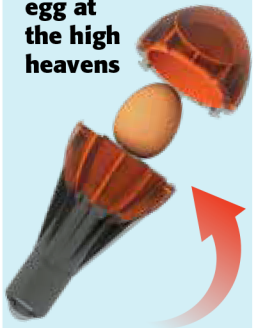

After assembling your EggsCaliber and Space Crater rocket nose cones, insert an egg into the payload and prepare for liftoff.



But be sure to prepare the parachute recovery system correctly, or you may end up with an egg-citing mess to clean up!



**2123 EggsCaliber™**

Length: 20 in. (50.8 cm)  
 Diameter: 1 in. (25 mm)  
 Estimated Weight: (without egg): 2.6 oz. (74 g)  
 Fins: Laser cut wood  
 Recovery:  
 1x 12 in. (30.5 cm) Parachute,  
 1x 18 in. (45.7 cm) Parachute  
 Projected Altitude: 1700 ft. (518 m) without egg  
 Recommended Engines: With egg: B6-2 for first launch; C6-3, C11-3, D12-3, E9-4;  
 Without egg: B4-2 for first launch;  
 B6-2, C6-5, D12-5  
 Requires 3/16 in. (5 mm) Maxi™ Launch Rod  
 PN 2244; sold separately

**\$25.99**



**Become an eggspert rocketeer!**



**7265 Space Crater™**

Length: 18.5 in. (47 cm)  
 Diameter: 0.98 in. (25 mm)  
 Estimated Weight: 2.6 oz. (72.7 g)  
 Fins: Plastic  
 Recovery: 15 in. (38.1 cm) Parachute  
 Projected Altitude: 650 ft. (198 m)  
 Recommended Engines: Without egg:  
 B6-4 for first launch; C6-5. With egg:  
 C6-3

**\$22.99**



**9719 Super Big Bertha™**

Length: 36.8 in. (93.4 cm)  
 Diameter: 2.6 in. (66 mm)  
 Estimated Weight: 8.9 oz. (252.3 g)  
 Fins: Laser cut wood  
 Recovery: 24 in. (61 cm)  
 Parachute  
 Projected Altitude: 1200 ft. (366 m)  
 Recommended Engines:  
 E16-4 for first launch; F15-6  
 NOTE: This rocket can also be launched on a D12-3 engine when you purchase PN 9753 - 24 mm to 29 mm Engine Adapter.

**\$39.99**



**1261 Baby Bertha™**

Length: 12.8 in. (32.5 cm)  
 Diameter: 1.64 in. (42 mm)  
 Estimated Weight:  
 1.9 oz. (53.9 g)  
 Fins: Laser cut wood  
 Recovery: 12 in. (30.5 cm)  
 Parachute  
 Projected Altitude:  
 575 ft. (175 m)  
 Recommended Engines:  
 A8-3 for first launch; B4-4,  
 B6-4, C6-5

**\$14.99**



**1948 Big Bertha™**

Length: 24 in. (61 cm)  
 Diameter: 1.64 in. (42 mm)  
 Estimated Weight:  
 2.5 oz. (71 g)  
 Fins: Laser cut wood  
 Recovery: 18 in. (45.7 cm)  
 Parachute  
 Projected Altitude:  
 500 ft. (152 m)  
 Recommended Engines:  
 B6-4 for first launch; B4-2,  
 B4-4, B6-2, C6-5

**\$26.99**



**Bertha Rocket Sizes**

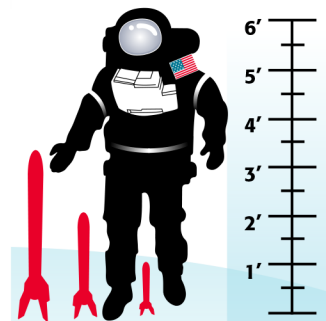

**Super Big Bertha,  
 Big Bertha & Baby Bertha**



**7246 Estes Shuttle™**

Length: 23.2 in. (58.9 cm)  
 Diameter: 2.6 in. (66 mm)  
 Estimated Weight: 9.5 oz. (269.3 g)  
 Shuttle length: 12.2 in (31 cm)  
 Shuttle wingspan: 8.9 in. (22.6 cm)  
 Fins: Laser cut wood  
 Recovery: 24 in. (61 cm) Parachute, glide  
 Projected Altitude: 500 ft. (152 m)  
 Recommended Engines:  
 D12-3 for first launch; E12-4  
 Requires 3/16 in. (5 mm) Maxi™ Launch Rod PN 2244; sold separately

**\$53.99**



**7257 Airborne Surveillance Missile**

The Estes Airborne Surveillance Missile packs a lot into a small package! Great flights on Estes mini-engines (not included)! You'll enjoy building this highly detailed, scale-like military missile.

Length: 11.3 in. (28.7 cm)  
 Diameter: 0.98 in. (25 mm)  
 Estimated Weight: 0.9 oz (26 g)  
 Fins: Laser cut wood  
 Recovery: 9 in. (22.9 cm) Parachute  
 Projected Altitude: 375 ft (114 m)  
 Recommended Engines:  
 A3-4T for first launch; A10-3T

**\$16.99**

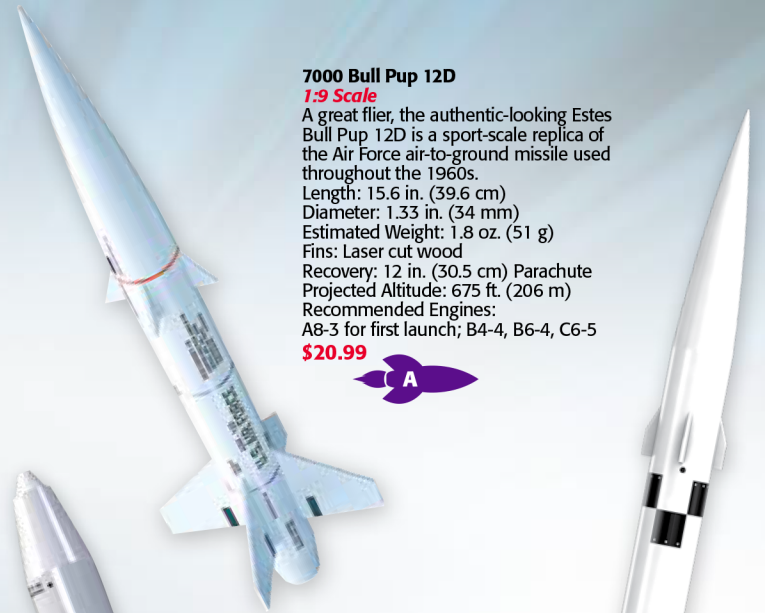

**7000 Bull Pup 12D**

**1:9 Scale**

A great flier, the authentic-looking Estes Bull Pup 12D is a sport-scale replica of the Air Force air-to-ground missile used throughout the 1960s.

Length: 15.6 in. (39.6 cm)  
 Diameter: 1.33 in. (34 mm)  
 Estimated Weight: 1.8 oz. (51 g)  
 Fins: Laser cut wood  
 Recovery: 12 in. (30.5 cm) Parachute  
 Projected Altitude: 675 ft. (206 m)  
 Recommended Engines:  
 A8-3 for first launch; B4-4, B6-4, C6-5

**\$20.99**



**7259 Nike-X**

Length: 23.4 in. (59.4 cm)  
 Diameter: 1.33 in. (34 mm)  
 Estimated Weight:  
 2.4 oz. (68 g)  
 Fins: Laser cut wood  
 Recovery: 15 in. (38.1 cm)  
 Parachute  
 Projected Altitude:  
 600 ft. (183 m)  
 Recommended Engines:  
 B6-4 for first launch; C6-5

**\$21.99**



**7266 Red Nova™**

The scale-like Estes Red Nova™ is impressive up close and in the sky! Great decals complete the scale-look. You'd swear it was real!

Length:  
 21.6 in. (54.9 cm)  
 Diameter:  
 1.64 in. (42 mm)  
 Estimated Weight:  
 3 oz. (85 g)  
 Fins: Laser cut wood  
 Recovery: 15 in. (38.1 cm)  
 Parachute  
 Projected Altitude:  
 800 ft. (244 m)  
 Recommended Engines:  
 D12-5 for first launch; D12-7  
 Requires 3/16 in. (5 mm)  
 Maxi™ Launch Rod PN 2244;  
 sold separately.

**\$21.99**





## Welcome to the exciting world of multi-stage rockets...

**Many full-size rockets** that leave earth's atmosphere are staged rockets. The amount of fuel required to lift millions of pounds of mass requires huge rockets that have multiple stages (segments) stacked on top of the main booster stage. Each upper stage requires its own rocket engine and fuel and each subsequent stage is used to increase velocity to escape earth's gravitational pull and reach Low Earth Orbit (LEO is 99 to 1,200 miles). While Estes multi-stage rockets will not get to LEO, they are designed to increase a model rocket's maximum altitude.

A 2-stage model rocket uses a first-stage booster engine (it has no ejection charge) to get the rocket moving vertically. When the booster engine uses up its propellant, it then ignites the upper stage engine. The booster separates from the upper stage and it tumbles to the ground. After the upper stage is ignited (also called a sustainer stage), it then accelerates to its maximum height (or apogee) and an ejection charge at apogee deploys the recovery system.

**Each multi-stage rocket booster contains an Estes engine. Once the engine fuel is exhausted, the boosters detach and tumble gently to the ground for reuse.**

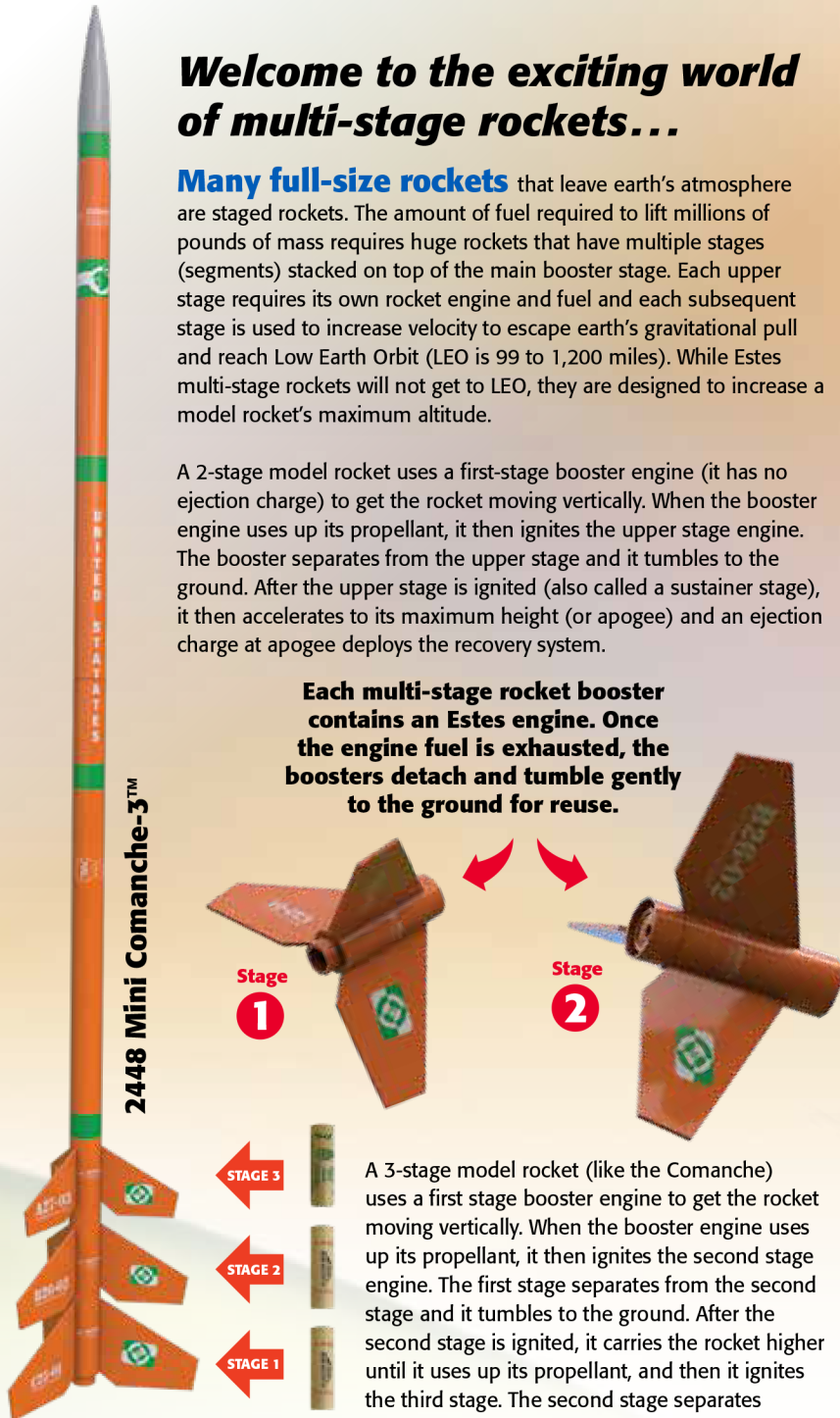

A 3-stage model rocket (like the Comanche) uses a first stage booster engine to get the rocket moving vertically. When the booster engine uses up its propellant, it then ignites the second stage engine. The first stage separates from the second stage and it tumbles to the ground. After the second stage is ignited, it carries the rocket higher until it uses up its propellant, and then it ignites the third stage. The second stage separates

... this is how *real* rockets fly!

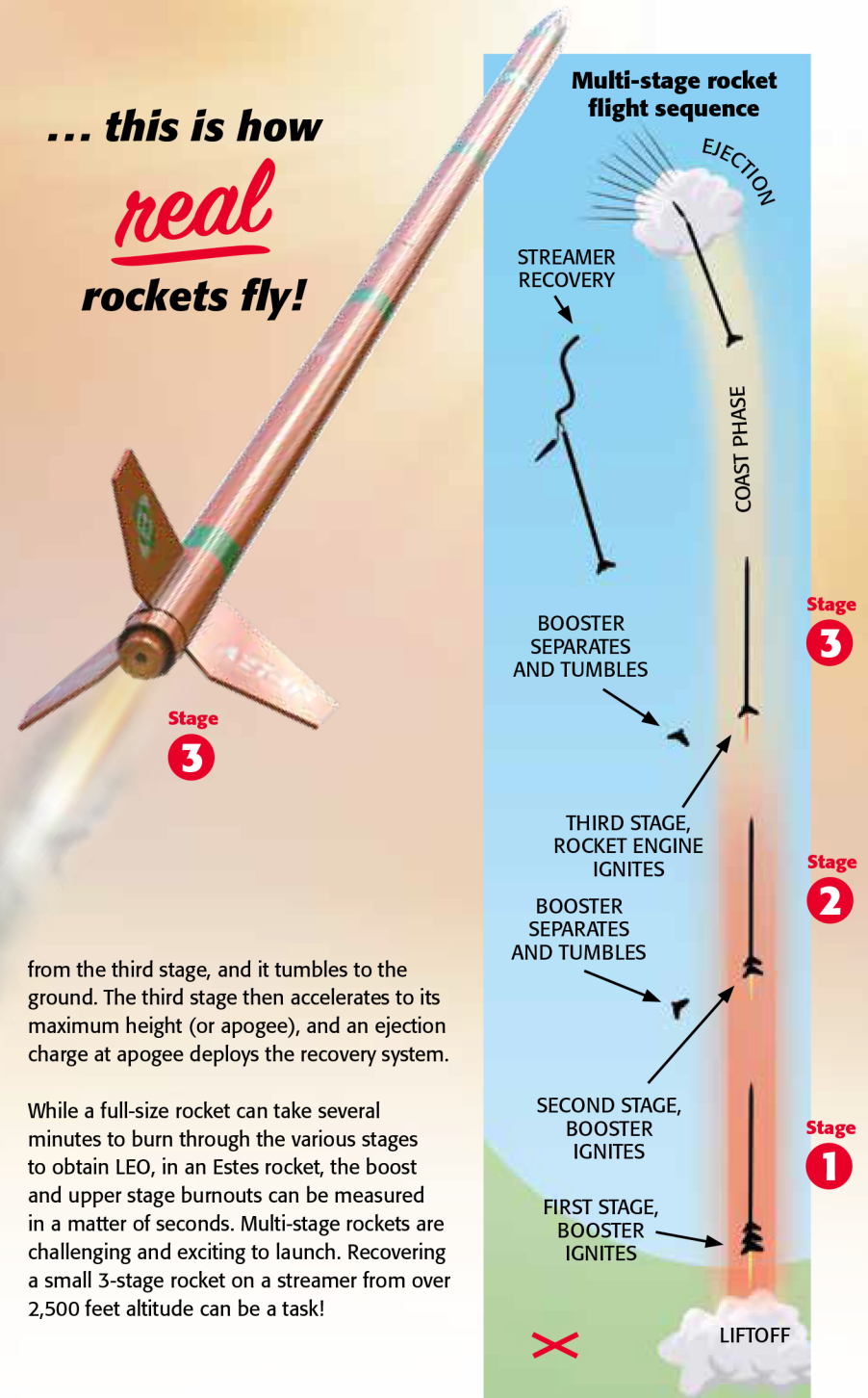

from the third stage, and it tumbles to the ground. The third stage then accelerates to its maximum height (or apogee), and an ejection charge at apogee deploys the recovery system.

While a full-size rocket can take several minutes to burn through the various stages to obtain LEO, in an Estes rocket, the boost and upper stage burnouts can be measured in a matter of seconds. Multi-stage rockets are challenging and exciting to launch. Recovering a small 3-stage rocket on a streamer from over 2,500 feet altitude can be a task!

### 1329 Multi-Roc™

Length: 25 in. (63.5 cm)  
 Diameter: 0.98 in. (25 mm)  
 Estimated Weight: 2.6 oz. (73.7 g)  
 Fins: Laser cut wood  
 Recovery: 12 in. (30.5 cm) Parachute;  
 Glide; Tumble  
 Projected Altitude: 1200 ft. (366 m)  
 Recommended Engines:  
 Single Stage rocket only – no booster:  
 B6-4 for first launch; B6-6, C6-5, C6-7  
 Two Stage rocket with booster:  
 Booster Stage:  
 B6-0 for first launch; C6-0  
 Second Stage Rocket:  
 B6-4 for first launch; B6-6, C6-5, C6-7

**\$22.99**



### 7250 Twin Factor™

Length: 6 in. (15.2 cm)  
 Diameter: 4.3 in. (10.9 cm)  
 Estimated Weight: 0.8 oz. (22.7 g)  
 Fins: Laser cut cardstock  
 Recovery: Tumble  
 Projected Altitude: 150 ft. (46 m)  
 Recommended Engines:  
 Single Stage rocket only – no booster:  
 A3-4T for first launch; A10-3T, A10-PT  
 Two Stage rocket with single booster:  
 Booster Stage: A10-0T  
 Second Stage Rocket:  
 A3-4T for first launch; 1/4A3-3T, 1/2A3-2T,  
 1/2A3-4T, A10-3

**\$13.99**



### 2092 Mongoose™

ALL PRE-COLORED PARTS!  
 Length: 27 in. (68.6 cm)  
 Diameter: 0.98 in. (25 mm)  
 Estimated Weight: 2.3 oz. (65 g)  
 Fins: Plastic  
 Recovery:  
 12 in. (30.5 cm) Parachute; Tumble  
 Projected Altitude: 1600 ft. (488 m)  
 Recommended Engines:  
 Single Stage rocket only – no booster:  
 A8-3 for first launch; B4-4, B6-4, C6-5.  
 Two Stage rocket with booster:  
 Booster Stage: B6-0 for first Flight; C6-0  
 Second Stage Rocket:  
 A8-5 for first launch; B6-6, C6-7

**\$16.99**



### 7276 Checkmate™

Length: 17 in. (43.2 cm)  
 Diameter: 0.74 in. (19 mm)  
 Estimated Weight:  
 1 oz. (28.3 g)  
 Fins: Laser cut wood  
 Recovery:  
 18 in. (45.7 cm) Streamer; Tumble  
 Projected Altitude: 900 ft. (274 m)  
 Recommended Engines:  
 Single Stage rocket only – no booster:  
 A3-4T for first launch; A10-3T  
 Two Stage rocket with booster:  
 Booster Stage A10-0.  
 Second Stage Rocket:  
 A3-4T for first launch; A10-3T

**\$12.99**



### 7275 Sterling Silver™

Length: 22 in. (55.9 cm)  
 Diameter: 0.74 in. (19 mm)  
 Estimated Weight:  
 1.1 oz. (31.2 g)  
 Fins: Laser cut wood  
 Recovery:  
 30 in. (76.2 cm) Streamer; Tumble  
 Projected Altitude:  
 2600 ft. (792 m)  
 Recommended Engines:  
 Single Stage rocket only – no booster:  
 A8-5 for first launch; B6-6, C6-7.  
 Two Stage rocket with booster:  
 Booster Stage: A8-0 for first launch;  
 B6-0, C6-0  
 Second Stage Rocket: A8-5 for first  
 launch; B6-6, C6-7

**\$14.99**



**NEW!**  
6 ways to launch!

**NEW!**

### 7217 Hyper Bat™

Length: 21.9 in. (55.6 cm)  
 Diameter: 0.98 in. (25 mm)  
 Estimated Weight: 1.8 oz. (51 g)  
 Fins: Laser cut wood  
 Recovery:  
 12 in. (30.5 cm) Parachute; Tumble  
 Projected Altitude: 2125 ft. (648 m)  
 Recommended Engines:  
 Rocket Only: B6-4 for first launch;  
 B6-6, C6-5, C6-7  
 Two Stage: Booster: B6-0 for first  
 launch; A8-0, C6-0  
 Upper Stage: B6-6 for first launch;  
 A8-5, C6-5, C6-7

**\$17.99**



### 1946 Boosted Bertha™

Length: 21.9 in. (55.6 cm)  
 Diameter: 1.64 in. (42 mm)  
 Estimated Weight: 4 oz. (113.4 g)  
 Fins: Laser cut wood  
 Recovery: 18 in. (45.7) Parachute; Tumble  
 Projected Altitude: 1000 ft. (305 m)  
 Recommended Engines:  
 Single Stage rocket only – no booster:  
 B6-4 for first launch; B6-6, C6-5 and C6-7.  
 Two Stage rocket with booster:  
 Booster Stage: B6-0 for first launch; A8-0, C6-0  
 Second Stage Rocket: B6-6 for first launch; A8-5,  
 B6-4, C6-5, C6-7

**\$29.99**





### 2448 Mini Comanche-3™

Length: 31.1 in. (79 cm)  
 Diameter: 0.74 in. (19 mm)  
 Estimated Weight: 1.5 oz. (42.5 g)  
 Fins: Laser cut wood  
 Recovery:  
 18 in. (45.7 cm) Streamer; Tumble  
 Projected Altitude: 900 ft. (274 m)  
 Recommended Engines:  
 Single Stage rocket only – no booster:  
 1/4A3-3T for first launch; 1/2A3-2T,  
 A3-4T, A10-3  
 Two Stage rocket with single booster:  
 Booster Stage: A10-0T  
 Second Stage Rocket:  
 A3-4T for first launch; A10-3T  
 Three Stage rocket with two boosters:  
 First Stage booster: A10-0T  
 Second Stage booster: A10-0T  
 Third Stage Rocket: A3-4T for first  
 launch; or A10-3T

**\$14.99**



### 7245 Comanche-3™

Length: 41 in. (104.1 cm)  
 Diameter: 0.98 in. (25 mm)  
 Estimated Weight: 2.5 oz. (70.9 g)  
 Fins: Laser cut wood  
 Recovery: 36 in. (91.4 cm) Dual  
 Streamer; Tumble  
 Projected Altitude: 2250 ft. (686 m)  
 Recommended Engines:  
 Single Stage rocket only – no booster:  
 A8-3 for first launch; B4-4, B6-4, C6-5  
 Two Stage rocket with single booster:  
 Booster Stage: C6-0  
 Second Stage Rocket: B4-4, B6-6, C6-7  
 Three Stage rocket with two boosters:  
 First Stage booster: C11-0 or D12-0  
 Second Stage booster: B6-0 or C6-0  
 Third Stage Rocket: B6-6 or C6-7

**\$23.99**



**The Comanche  
 models are  
 3-stage rockets  
 with 2 boosters  
 that can attain  
 extremely high  
 altitudes!**



### 2437 Savage™

Length: 31.8 in. (80.8 cm)  
 Diameter: 1.33 in. (34 mm)  
 Estimated Weight:  
 4.7 oz (133.2 g)  
 Fins: Plastic  
 Recovery:  
 15 in. (38.1 cm) Parachute; Tumble  
 Projected Altitude:  
 1600 ft. (488 m)  
 2437 Savage  
 Recommended Engines:  
 Single Stage rocket only – no booster:  
 B6-4 for first launch; B4-2, B6-2, C6-5  
 Two Stage rocket with booster:  
 Booster Stage: D12-0  
 Second Stage Rocket: B6-4 for first  
 launch; A8-5, B6-6, C6-5, C6-7

**\$25.99**



### Comanche Series Sizes

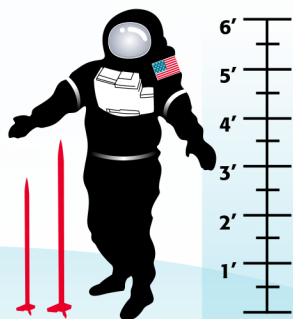

**Mini-Comanche-3  
 & Comanche-3**

**With the  
 Loadstar II  
 nose cone  
 payload,  
 you can blast  
 bugs up to  
 1000 ft. in  
 the air!**



### 3227 Loadstar™ II

Length: 23.3 in. (59.2 cm)  
 Diameter: 1.33 in. (34 mm)  
 Payload Diameter: 1.64 in. (42 mm)  
 Estimated Weight: 2.8 oz. (79.4 g)  
 Fins: Laser cut wood  
 Recovery: 18 in. (45.7 cm) Parachute; Tumble  
 Projected Altitude: 1000 ft. (305 m)  
 Recommended Engines:  
 Single Stage rocket only – no booster:  
 B4-4 for first launch; B6-4, C6-5  
 Two Stage rocket with booster:  
 Booster Stage: B6-0 for first launch; C6-0  
 Second Stage Rocket:  
 A8-5 for first launch; B6-4, B6-6 and C6-7

**\$22.99**



### SPACE EXPLORER



**Recruit your  
 own fleet of  
 insectronauts!**

### 7248 Supernova™

Length: 27.5 in. (69.9 cm)  
 Diameter: 0.98 in. (25 mm)  
 Estimated Weight: 2 oz. (56.7 g)  
 Fins: Laser cut wood  
 Recovery:  
 9 in. (22.9 cm) Parachute; Tumble  
 Projected Altitude:  
 1550 ft. (472 m)  
 Recommended Engines:  
 Single Stage rocket only – no booster:  
 B4-4 for first launch; A8-5, B6-4, C6-5  
 Two Stage rocket with booster:  
 Booster Stage:  
 B6-0 for first launch; C6-0  
 Second Stage Rocket: A8-5 for first  
 launch; B6-6, C6-7

**\$22.99**





The Double Ringer has unique cylindrical gliders that detach and circle back to earth.

**What goes up...**

**... must come down in *fun* fashion!**

### Fun Recovery Systems

Watching your model rocket liftoff is only part of the fun — seeing the whoosh — pop of the parachute when the rocket reaches apogee is equally thrilling! Estes model rocketry recovery systems vary depending upon each rocket's specifications and engineering design. Most model rockets rely on traditional parachute or streamer recovery. Factors such as rocket size, engine power, and launch site dimension, are used to determine the size or number of parachutes to be used or if a streamer should be used to keep a high-performance rocket from drifting too far from the launch site and getting lost. A few model rockets are so light that they either simply tumble or flutter gently back to earth; in essence, their lightweight construction is the recovery system. And then there are combinations of recovery systems and other unique methods of recovery. These include spin and glide recovery. Spin recovery is created by the rocket's spinning (usually with helicopter blades), creating drag. Glide recovery utilizes lift created by varying wing shapes and designs, requiring careful trimming for optimum performance. Every Estes model rocket includes a recovery system so that you can launch it over and over again!



**NEW!**

**7279 Double Ringer™**  
 Length: 25.3 in. (64.3)  
 Diameter: 1.33 in. (34 mm)  
 Estimated Weight: 3.8 oz. (107.8 g)  
 Fins: Plastic  
 Recovery:  
 15 in. (38.1 cm) Parachute; Glide  
 Projected Altitude: 500 ft. (152 m)  
 Recommended Engines:  
 B6-2 for first launch; C6-3  
**\$19.99**



**2416 Flip Flyer™**  
 Length: 19.2 in. (48.8 cm)  
 Diameter: 0.98 in. (25 mm)  
 Estimated Weight: 3.2 oz. (90.7 g)  
 Fins: Plastic  
 Recovery:  
 9 in. (22.9 cm) Parachute; Spin  
 Projected Altitude: 900 ft. (274 m)  
 Recommended Engines:  
 B6-4 for first launch; C6-5  
**\$20.99**



**2183 Shuttle Xpress™**

Length: 17.7 in. (45 cm)  
Diameter: 1.35 in. (34 mm)  
Estimated Weight: 3.2 oz. (90.7 g)  
Fins: Plastic  
Recovery: 12 in. (30.5 cm) Parachute; Glide  
Projected Altitude: 600 ft. (183 m)  
Recommended Engines: B4-2 for first launch; B4-4, B6-2, B6-4, C6-3, C6-5

**\$20.99**



**A perfect competition rocket featuring helicopter blades!**



**The Shuttle Express model rocket is equipped with two gliders that detach and glide back to earth during recovery!**



**7272 Mini "A" Heli**

Length: 17 in. (43.2 cm)  
Diameter: 0.54 in. (14 mm)  
Rotor Diameter: 24.2 in. (61.5 cm)  
Estimated Weight: 0.76 oz. (21.5 g)  
Fins: Laser cut wood  
Recovery: Spin  
Projected Altitude: 400 ft. (122 m)  
Recommended Engines: A10-3T

**\$14.99**



**The Quinstar rocket has a unique design that allows it to spin rapidly as it lifts into the sky and as it returns to the ground.**



**7241 Quinstar™**

Height: 3 in. (7.6 cm)  
Diameter: 8 in. (20.3 cm)  
Estimated Weight: 0.8 oz. (22.7 g)  
Fins: Laser cut wood  
Recovery: Spin  
Projected Altitude: 150 ft. (46 m)  
Recommended Engines: B6-0 for first launch; C6-0

**\$21.99**

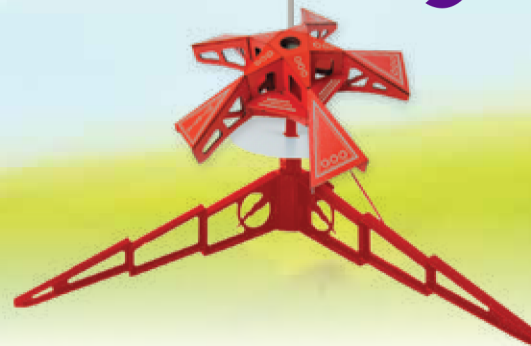

**Quinstar flight sequence**

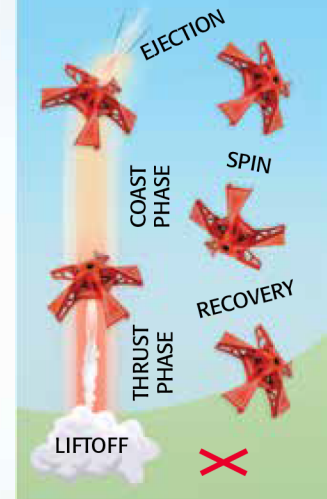

**The Quinstar is a lightweight rocket which allows for a spin recovery that requires no parachute.**





*Imagine  
new worlds!*

**What's your story  
for these unique rockets?**

**7260 Protostar™**

Length: 24 in. (61 cm)  
Diameter: 1.64 in. (42 mm)  
Estimated Weight: 5 oz. (141.7 g)  
Fins: Laser cut wood  
Recovery:  
18 in. (45.7 cm) Parachute  
Projected Altitude:  
1350 ft. (411 m)  
Recommended Engines: C11-3 for  
first launch; D12-5, E12-6  
Requires 3/16 in. (5 mm) Maxi™  
Launch Rod PN 2244; sold separately

**\$30.99**



**7249 Expedition™**

Length: 25.6 in. (65.1 cm)  
Diameter: 2.22 in. (56 mm)  
Estimated Weight: 5 oz. (141.8 g)  
Fins: Laser cut wood  
Recovery:  
18 in. (45.7 cm) Parachute  
Projected Altitude: 1100 ft. (305 m)  
Recommended Engines:  
C11-3 for first launch; D12-5, E12-4  
Requires 3/16 in. (5 mm) Maxi™ Launch  
Rod PN 2244; sold separately

**\$27.99**



**7262 Starship Nova™**

Length: 20 in. (50.8 cm)  
Diameter: 0.98 in. (25 mm)  
Estimated Weight: 2.1 oz. (59.5 g)  
Fins: Laser cut wood  
Recovery: 15 in. (38.1 cm) Parachute  
Projected Altitude: 500 ft. (152 m)  
Recommended Engines: B4-2 for first launch;  
B6-2, C6-3, C6-5

**\$24.99**



**7264 Astron Explorer™**

Length: 42.2 in. (107.2 cm)  
Diameter: 1.33 in. (34 mm)  
Estimated Weight: 6 oz. (170.1 g)  
Fins: Laser cut wood  
Recovery:  
18 in. (45.7 cm) Parachute  
Projected Altitude: 1200 ft. (366 m)  
Recommended Engines:  
D12-3 for first launch; E12-4  
Requires 3/16 in. (5 mm) Maxi™  
Launch Rod PN 2244; sold  
separately

**\$27.99**

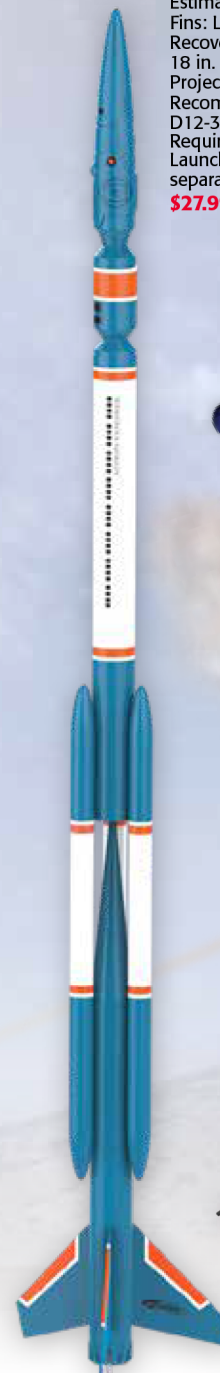

**7230 Conquest™**

The Estes Conquest™ is a scale-like  
model of the next-generation pilotless  
supersonic interceptor. A real builder's  
challenge, this well-crafted kit will stand  
out as the pride of your fleet!  
Length: 28.6 in. (72.6 cm)  
Diameter: 1.64 in. (42 mm)  
Wingspan: 12.8 in. (32.5 cm)  
Estimated Weight: 5.5 oz. (155.9 g)  
Fins: Laser cut wood  
Recovery: 18 in. (45.7 cm) Parachute  
Projected Altitude: 1100 ft. (335 m)  
Recommended Engines:  
D12-3 for first launch; E12-4  
Requires 3/16 in. (5 mm) Maxi™ Launch  
Rod PN 2244; sold separately.

**\$34.99**



**7233 Lynx™**

Length: 13 in. (33 cm)  
Diameter: 0.74 in. (19 cm)  
Estimated Weight: 1.2 oz. (34 g)  
Fins: Laser cut wood  
Recovery: 12 in. (30.5 cm) Parachute  
Projected Altitude: 400 ft. (122 m)  
Recommended Engines:  
A3-4T for first launch; A10-3T

**\$14.99**



### 1250 Interceptor™

Standing over 2 ft. tall, this model rocket features laser cut precision balsa parts, a slotted body tube for extra secure wing and fin mounting, a detailed blow molded nose cone and three 5-color decal sheets that will finish this model with eye-popping décor!

Length: 26 in. (66 cm)  
Diameter: 1.33 in. (34 mm)  
Estimated Weight: 3.9 oz. (110.6 g)  
Fins: Laser cut wood  
Recovery: 18 in. (45.7 cm) Parachute  
Projected Altitude: 525 ft. (160 m)  
Recommended Engines: B4-2 for first launch;  
B6-4, C6-5

**\$29.99**



### 7235 Odyssey™

Length: 22.7 in. (57.7 cm)  
Diameter: 1.33 in. (34 mm)  
Wingspan: 11 in. (27.9 cm)  
Estimated Weight: 5 oz. (141.8 g)  
Fins: Laser cut wood  
Recovery: 18 in. (45.7 cm) Parachute  
Projected Altitude: 950 ft. (290 m)  
Recommended Engines:  
C11-3 for first launch; D12-5  
Requires 3/16 in. (5 mm) Maxi™  
Launch Rod PN 2244; sold separately.

**\$29.99**



### 7256 Puma™

The Puma is a mini-engine powered and a must have to add to your collection! It will challenge your building skills just a bit, but when you are finished, the PUMA is a rocket you will be proud of! It's quick off the pad, so keep your eyes open!

Length: 12.3 in. (31.2 cm)  
Diameter: 0.74 in. (18 mm)  
Estimated Weight: .8 oz. (22.7 g)  
Fins: Laser cut wood  
Recovery: 9 in. (22.9 cm) Parachute  
Projected Altitude: 400 ft. (122 m)  
Recommended Engines: A3-4T for first launch; A10-3T

**\$14.99**



### 7253 Explorer Aquarius™

A scale-like model of the future, the interstellar voyager Explorer Aquarius. Stretch your skills with this unique and challenging kit. A great looker on the pad and in the air!

Length: 21.8 in. (55.4 cm)  
Diameter: 2.75 in. (70 mm)  
Estimated Weight: 4.2 oz. (119.1 g)  
Fins: Laser cut wood  
Recovery: 18 in. (45.7 cm) Parachute  
Projected Altitude: 750 ft. (229 m)  
Recommended Engines: D12-3 for first launch; D12-5, E12-4, E12-6  
Requires 3/16 in. (5 mm) Maxi™ Launch Rod PN 2244; sold separately.

**\$38.99**





 **ESTES** is a  
scale modeler's *dream!*

For more than 60 years, Estes has produced the finest scale replicas of rockets and missiles. Here's some of our past, present, and maybe future kits.





## Scale model rockets make history and your hobbies come...



...to *Life!*

### Scale model rockets

in this category are detailed, miniature replicas of full-scale military, commercial, or space agency rockets, which come in a variety of scale sizes and model rocket engine requirements. Rockets in this class usually require advanced-level building skills using many handcrafted or molded detail parts. These rockets often require that rocketeers attempting to build these models have mastered a variety of skills in assembly, painting, and launching techniques.

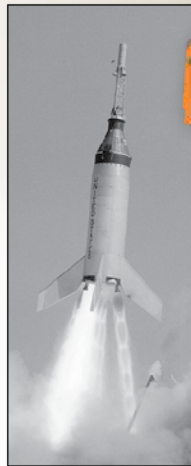

The Little Joe I booster was the first rocket designed solely for manned spacecraft qualifications and to measure critical parameters in flight.



**7255 Little Joe I 1:34 Scale**  
Length: 17.62 in. (44.75 cm)  
Diameter: 2.34 in. (59.43 mm)  
Estimated Weight: 3.2 oz. (90.7 g)  
Fins: Laser cut wood  
Recovery:  
15 in. (38.1 cm) Parachute  
Projected Altitude: 400 ft. (122 m)  
Recommended Engines: B6-4 for first launch; C6-5  
**\$32.99**



Little Joe II was used from 1963–1966 for five unmanned tests of the Apollo spacecraft launch escape system.

**7227 Apollo Little Joe II 1:45 Scale**

Length: 23.3 in. (59.18 cm)  
Diameter: 3.42 in. (86.9 mm)  
Estimated Weight: 8.3 oz. (235.3 g)  
Fins: Plastic  
Recovery: 24 in. (61 cm) P parachute  
Projected Altitude: 800 ft. (244 m)  
Recommended Engines:  
Composite E30-4  
Requires 3/16 in. (5 mm) Maxi™ launch rod (2244), sold separately.  
**\$53.99**



**1921 Liberty Bell 7 Mercury Redstone 1:34 Scale**

Length: 28.6 in. (72.6 cm)  
Diameter: 2.05 in. (53 mm)  
Estimated Weight: 3.07 oz. (104.9 g)  
Fins: Laser cut wood  
Recovery:  
15 in. (38.1 cm) Parachute  
Projected Altitude: 200 ft. (61 m)  
Recommended Engines: C6-3  
**\$26.99**

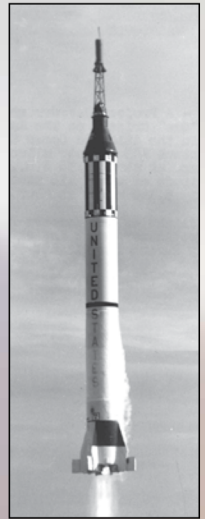

The Mercury-Redstone 4 was the second United States human spaceflight. Piloted by astronaut Virgil "Gus" Grissom, it launched on July 21, 1961.



**2446 Mini Honest John 1:24 Scale**

Check out this mini-engine powered version of the U.S. Army Honest John. The Estes Mini Honest John is a sport scale model featuring a molded plastic nose cone and balsa fins that's quick to build and fun to fly!

Length: 11.75 in. (29.8 cm)  
Diameter: 0.98 in. (25 mm)  
Estimated Weight: 1.2 oz. (34 g)  
Fins: Laser cut wood  
Recovery: 12 in. (30.5 cm) Parachute  
Projected Altitude: 325 ft. (99 m)  
Recommended Engines: 1/2A3-2T for first launch; A3-4T, A10-3T

**\$12.99**



An iconic weapon of the Cold War, the MGR-1 Honest John battlefield rocket could carry nuclear or conventional warheads.

**7240 Honest John 1:14 Scale**

Length: 23 in. (58.4 cm)  
Diameter: 1.64 in. (42 mm)  
Estimated Weight: 4.4 oz. (124.7 g)  
Fins: Laser cut wood  
Recovery: 15 in. (38.1 cm) Parachute  
Projected Altitude: 1400 ft. (427 m)  
Recommended Engines: D12-5 for first launch; C11-3, E12-6  
Requires 3/16 in. (5 mm) Maxi™ Launch Rod (2244), sold separately.

**\$28.99**



Made to be a fin-stabilized, unguided artillery rocket, the Honest John was mounted on the back of military trucks. It had a range of 15.4 miles with a 20 kiloton nuclear warhead or a 1500 pound conventional warhead.

**2056 U.S. Army Patriot M-104 1:10 Scale**

Length: 21.3 in. (54.1 cm)  
Diameter: 1.64 in. (42 mm)  
Estimated Weight: 2 oz. (56.7 g)  
Fins: Laser cut wood  
Recovery: 12 in. (30.5 cm) Parachute  
Projected Altitude: 600 ft. (183 m)  
Recommended Engines: B4-4 for first launch; B6-4, B6-6, C6-5

**\$18.99**



The MIM-104 Patriot is a surface-to-air missile system used by the United States Army and several allied nations.



After capture by American forces at the end of WWII, dozens of German V2 ballistic missiles were brought to White Sands, New Mexico for testing, and formed the basis for the U.S. space program.

**3228 V2 1:25 Scale**

Now you can build and fly your own scale model of the rocket that ushered in the space age! Standing at nearly 23 in., this impressive model flies up to 725 ft. on the recommended Estes E12 engines (not included)

Length: 22.4 in. (56.9 cm)  
Diameter: 2.6 in. (66 mm)  
Estimated Weight: 6.3 oz. (178.6 g)  
Fins: Laser cut wood  
Recovery: 18 in. (45.7 cm) Parachute  
Projected Altitude: 725 ft. (221 m)  
Recommended Engines: C11-3 for first launch; D12-3, E12-4, E12-6  
Requires 3/16 in. (5 mm) Maxi™ Launch Rod PN 2244; sold separately.

**\$26.99**





The Canadian Black Brant line of sounding rockets is one of the most successful launch vehicles ever flown. Since the late 1950s, several hundred Black Brant rockets have completed research missions for Canada and NASA.



**7243 Black Brant II 1:13 Scale**

The Estes Black Brant II is a 1:13 scale replica of one of the earliest of the Black Brant sounding rockets. Loaded with scale details, this rocket really moves using the recommended Estes D-12 engines (not included)  
 Length: 24.9 in. (63.2 cm)  
 Diameter: 1.33 in. (34 mm)  
 Estimated Weight: 3 oz. (85 g)  
 Fins: Laser cut wood  
 Recovery: 18 in. (45.7 cm) Parachute  
 Projected Altitude: 1300 ft. (396 m)  
 Recommended Engines: D12-5 for first launch; D12-7

**\$23.99**



**1293 Black Brant III 1:10 Scale**

This detailed, 1:10 scale model rocket is straightforward to build and an excellent kit for the first-time scale modeler.  
 Length: 20.4 in. (51.8 cm)  
 Diameter: 0.98 in. (25 mm)  
 Estimated Weight: 1.2 oz. (34 g)  
 Fins: Laser cut wood  
 Recovery: 12 in. (30.5 cm) Parachute  
 Projected Altitude: 1300 ft. (396 m)  
 Recommended Engines: A8-3 for first launch; 1/2A6-2, A8-5, B4-4, B6-4, B6-6, C6-5, C6-7

**\$14.99**



In service for nearly 22 years, the Black Brant III was a reliable sounding rocket for the Canadian Space Agency and NASA.



**7254 Nike Apache 1:12 Scale**

The Estes 1:12 model of this popular sounding rocket makes for a great introductory scale kit.  
 Length: 23 in. (58.4 cm)  
 Diameter: 1.33 in. (34 mm)  
 Estimated Weight: 1.8 oz. (51 g)  
 Fins: Laser cut wood  
 Recovery: 12 in. (30.5 cm) Parachute  
 Projected Altitude: 925 ft. (282 m)  
 Recommended Engines: A8-3 for first launch; B4-4, B6-4, C6-5, C6-7

**\$17.99**



The Nike Apache carried hundreds of NASA research projects aloft during its operational life.



The Nike Smoke was a sounding rocket, part of a research project on the behavior of the horizontal winds in the upper atmosphere it was developed by NASA in the 1960s and was based on the Nike booster.



**7247 Nike Smoke 1:10 Scale**

Now you can build your own 1:10 scale replica of the NASA Nike Smoke sounding rocket! This large, scale model rocket is made from quality Estes parts and looks as great as it flies!  
 Length: 22.9 in. (58.2 cm)  
 Diameter: 1.64 in. (42 mm)  
 Estimated Weight: 2.4 oz. (68 g)  
 Fins: Laser cut wood  
 Recovery: 15 in. (38.1 cm) Parachute  
 Projected Altitude: 650 ft. (198 m)  
 Recommended Engines: B6-4 for first launch; C6-5

**\$24.99**





NEW EASIER TO ASSEMBLE ESCAPE TOWER

NEW!

DETAILED BLOW MOLDED TRANSITION

ACCURATE APOLLO II BODY WRAPS

Includes 1:100 Lunar Module to build and display right alongside your Saturn V.

**#1969 Anniversary Saturn V Flying Model Rocket Kit 1:100 Scale**

Length: 43.25 in. (110 cm)  
 Diameter: 3.94 in. (100 mm)  
 Estimated Weight: 11 oz. (311.8 g)  
 Fins: Plastic  
 Recovery: 2x 24 in. (61 cm) 1x 18 in. (46 cm) Parachutes  
 Projected Altitude: 350 ft. (107 m)  
 Recommended Engines: E12-4 for first launch; E30-4  
**\$89.99**



INJECTION MOLDED FINS

HIGHLY DETAILED REMOVABLE DISPLAY NOZZLES

**1969 Saturn V 1:100 Scale**

First introduced in 1970, the original Estes Saturn V has been built and launched by thousands of space adventurers, and with this 50th anniversary release, Estes has endeavored to create a more accurate reproduction of this historic model by retooling all the plastic detail parts, including the Apollo 11 capsule, Command/Service Module (now a detailed blow molded part), fins, engines and body wraps. Additionally, Estes partnered with Revell Models and is including a 1:100 plastic scale model of the "Apollo II Lunar Excursion Module" used by Neil Armstrong and Buzz Aldrin for that first "giant leap for mankind". This highly detailed LEM model will provide the consumer/collector with an exceptionally complete scale model celebrating "the single most important event" in recorded history.



Bonus!



NEW!

Comes with an offer for this limited edition poster!

**#2160 Anniversary Saturn V Almost Ready to Fly Model Rocket 1:200 Scale**

Length: 21.8 in. (51.8 cm)  
 Diameter: 1.98 in. (50 mm)  
 Estimated Weight: 5 oz. (141.7 g)  
 Fins: Plastic  
 Recovery: 18 in. (45.7 cm) Parachute  
 Projected Altitude: 200 ft. (61 m)  
 Recommended Engines: C6-3  
**\$69.99**



**2160 Saturn V 1:200 Scale**

The Estes limited production and commemorative 1:200 scale Apollo II Saturn V model is almost 2 feet tall and comes fully assembled with many scale details and markings carefully reproduced for exceptional realism. This historical model of the Saturn V is suitable for display or can be launched next July 16th 2019 to celebrate the historic 50th anniversary of landing the first man on the moon.

The 2160 Saturn V rocket comes almost ready to fly out of the box.

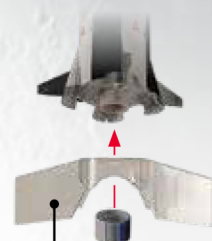

CLEAR PLASTIC FIN UNIT FOR FLIGHT

DISPLAY STAND INCLUDED



# Fly big!

Attain great heights with these challenging builds and flights.

**2162 Big Daddy™**  
 Length: 19 in. (48.3 cm)  
 Diameter: 3 in. (76 mm)  
 Estimated Weight: 5.3 oz. (150.3 g)  
 Fins: Laser cut wood  
 Recovery: 24 in. (61 cm) Parachute  
 Projected Altitude: 900 ft. (274 m)  
 Recommended Engines: C11-3 for first launch; D12-3, D12-5, E12-4, E12-6  
 Requires 3/16 in. (5 mm) Maxi™ Launch Rod PN 2244; sold separately.

**\$34.99**



**NEW MULTI-STAGE ROCKET!**

**7271 SA-2061Sasha™**  
 Length: 31.5 in. (80 cm)  
 Diameter: 1.64 in. (42 mm)  
 Estimated Weight: 6.1 oz. (172.9 g)  
 Fins: Laser cut wood  
 Recovery: 18 in. (45.7 cm) Parachute  
 Projected Altitude: 2300 ft. (701 m)  
 Recommended Engines:  
 Upper Stage: D12-5 for first launch; E12-6  
 With booster: D12-7 for first launch; D12-0, E12-0, E12-8  
 Requires 3/16 in. (5 mm) Maxi™ Launch Rod PN 2244; sold separately.

**\$29.99**



**2440 Magician™**  
 Length: 34 in. (86.4 cm)  
 Diameter: 1.33 in. (34 mm)  
 Estimated Weight: 3.5 oz. (100 g)  
 Fins: Laser cut wood  
 Recovery: 18 in. (45.7 cm) Parachute  
 Projected Altitude: 1600 ft. (488 m)  
 Recommended Engines: D12-5 for first launch; E12-6  
 Requires 3/16 in. (5 mm) Maxi™ launch rod PN 2244; sold separately.

**\$23.99**



**3226 Hi-Flier® XL**  
 Length: 31 in. (78.7 cm)  
 Diameter: 1.64 in. (42 mm)  
 Estimated Weight: 3.5 oz. (99.2 g)  
 Fins: Laser cut wood  
 Recovery: 18 in. (45.7 cm) Parachute  
 Projected Altitude: 1325 ft. (404 m)  
 Recommended Engines: C11-3 for first launch; D12-5, D12-7, E12-6, E12-8  
 Requires 3/16 in. (5 mm) Maxi™ Launch Rod PN 2244; sold separately.

**\$21.99**



**1951 Executioner**  
 Length: 38.5 in. (97.8 cm)  
 Diameter: 2.6 in. (66 mm)  
 Estimated Weight: 8.1 oz. (229.9 g)  
 Fins: Laser cut wood  
 Recovery: 24 in. (61 cm) Parachute  
 Projected Altitude: 600 ft. (183 m)  
 Recommended Engines: D12-3 for first launch; D12-5, E12-4, E12-6

**\$34.99**



**7225 Extreme 12™**  
 Length: 46.4 in. (117.8 cm)  
 Diameter: 1.64 in. (42 mm)  
 Estimated Weight: 7.1 oz. (201.3 g)  
 Fins: Laser cut wood  
 Recovery: 18 in. (35.7 cm) Parachute  
 Projected Altitude: 1900 ft. (579 m)  
 Recommended Engines:  
 Single Stage: D12-3, D12-5 for first launch; E12-4, E12-6  
 With Booster:  
 D12-5 for first launch; D12-0, E12-0, D12-7, E12-6, E12-8  
 Requires 3/16 in. (5 mm) Maxi™ Launch Rod PN 2244; sold separately.

**\$32.99**





## Pro Series II:

- Our biggest rockets!
- Fly with our biggest engines!
- The biggest thrills you can experience with Estes!
- This is where your journey from your first Alpha rocket launch takes you!

**Sturdy pre-slotted body tube for fin alignment & strength**

**5:1 ogive for speed**

**Flies up to 2,000 ft!**

**Pre-assembled fabric parachute**

**29 mm engine mount**

**Centering rings hold fins in place**

**Pre-assembled air-foiled fins**

**Screw-on engine retainer**



### 9716 Star Orbiter™

Length: 45.2 in. (114.8 cm)  
 Diameter: 1.64 in. (42 mm)  
 Estimated Weight: 5.9 oz. (167.2 g)  
 Fins: Laser cut wood  
 Recovery: 18 in. (45.7 cm) Nylon Parachute  
 Projected Altitude: 1800 ft. (549 m)  
 Recommended Engines:  
 E16-6 for first launch; F15-8  
**\$24.99**



### 9707 Majestic™

Length: 35.3 in. (89.7 cm)  
 Diameter: 2 in. (5.1 cm)  
 Estimated Weight: 9.6 oz (272.2 g)  
 Fins: Plastic  
 Recovery: 18 in. (45.7 cm) Nylon Parachute  
 Projected Altitude: 2000 ft. (610 m)  
 Recommended Engines: E16-6, F15-6 for first launch; F15-8  
**\$48.99**



**Ascender with booster flown on two F-15s, 99 N-SEC total impulse 7 second burn time.**

**9706 Ascender™**  
 Length: 42.1 in. (106.9 cm)  
 Diameter: 2 in. (5.1 cm)  
 Estimated Weight: 11 oz (311.8 g)  
 Fins: Plastic.  
 Recovery: 18" Nylon Parachute  
 Projected Altitude: 2000 ft. (610 m)  
 Recommended Engines: E16-6, F15-6 for first launch; F15-8  
**\$44.99**



**2240 PS II™ Launch Controller**

- 2240 Pro Series II Launch Controller
- 30 feet launch cable
- Required set back distance for rocket engines with more than 30 g propellant
- Audible Continuity
- Easily hear if the starter is connected correctly
- Two hands required for launch
- Even with the Safety Key left in, the rocket will not launch without both buttons pressed
- Requires 4 "C" size alkaline batteries  
**\$39.99**

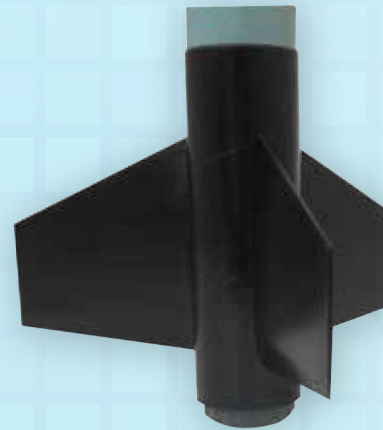

**9752 PS II™ Booster**  
 For use with rockets 9706 Ascender™, and 9707 Majestic™  
 Recommended Engine: F15-0  
**\$9.99**



**9753 PS II™ 24 mm to 29 mm Engine Adapter Set**  
**\$5.99**



**3172 PS II™ Shock Cord Accessory Pack**  
 3 heavy-duty elastic shock cords;  
 1/2 in. (13 mm) x 96 in. (243.8 cm)  
**\$10.99**



**3556 PS II™ Recovery Wadding**  
 Approximately 225 sheets for larger rockets. Can be used in any Estes rocket.  
**\$9.99**



**3552 PS II™ Launch Base**

- It stands 18 inches off the ground!
- Sturdy enough to launch our biggest Pro Series rockets
- Tiltable
- Make adjustments to the launch angle
- Two-piece 3/16 inch Rod
- Easily stores inside a pad leg  
**\$39.99**



## MODEL ROCKET ENGINE PERFORMANCE CHART

- Delays have a tolerance of plus or minus 10% or one second, whichever is greater.
- All Estes engines come complete with starters and starter plugs.
- The Estes starter plug makes engine ignition extremely reliable.

| Prod. No.                   | Engine Type | Total Impulse | Time Delay | Est. Max. Lift Wt. | Max Thrust |       | Thrust Duration | Initial Weight |      | Propellant Weight | Quantity per Pack | Retail Price per Pack |   |         |
|-----------------------------|-------------|---------------|------------|--------------------|------------|-------|-----------------|----------------|------|-------------------|-------------------|-----------------------|---|---------|
|                             |             |               |            |                    | Newtons    | lbs   |                 | oz             | g    |                   |                   |                       |   |         |
| <b>SINGLE STAGE ENGINES</b> |             |               |            |                    |            |       |                 |                |      |                   |                   |                       |   |         |
| 1502                        | 1/4A3-3T    | 0.625         | 3          | 1.0                | 28         | 4.90  | 1.1             | 0.25           | 0.21 | 5.9               | 0.05              | 1.3                   | 4 | \$10.29 |
| 1503                        | 1/2A3-2T    | 1.25          | 2          | 2.0                | 57         | 8.30  | 1.9             | 0.30           | 0.23 | 6.4               | 0.07              | 1.9                   | 4 | \$10.29 |
| 1507                        | A3-4T       | 2.50          | 4          | 2.0                | 57         | 6.80  | 1.5             | 0.60           | 0.28 | 8.0               | 0.12              | 3.3                   | 4 | \$10.29 |
| 1511                        | A10-3T      | 2.50          | 3          | 3.0                | 85         | 13.00 | 2.9             | 0.80           | 0.29 | 8.1               | 0.12              | 3.5                   | 4 | \$10.29 |
| 1593                        | 1/2A6-2     | 1.25          | 2          | 2.0                | 57         | 8.90  | 2.0             | 0.30           | 0.48 | 13.6              | 0.10              | 2.7                   | 3 | \$10.29 |
| 1598                        | A8-3        | 2.50          | 3          | 3.0                | 85         | 10.70 | 2.4             | 0.50           | 0.55 | 15.5              | 0.14              | 4.1                   | 3 | \$10.29 |
| 1601                        | B4-2        | 5.00          | 2          | 4.0                | 113        | 13.20 | 3.0             | 1.10           | 0.68 | 18.6              | 0.27              | 7.6                   | 3 | \$10.79 |
| 1602                        | B4-4        | 5.00          | 4          | 3.5                | 99         | 13.20 | 3.0             | 1.10           | 0.68 | 19.2              | 0.27              | 7.6                   | 3 | \$10.79 |
| 1605                        | B6-2        | 5.00          | 2          | 4.5                | 127        | 12.10 | 2.7             | 0.80           | 0.61 | 17.3              | 0.23              | 6.5                   | 3 | \$10.79 |
| 1606                        | B6-4        | 5.00          | 4          | 4.0                | 113        | 12.10 | 2.7             | 0.80           | 0.63 | 17.8              | 0.23              | 6.5                   | 3 | \$10.79 |
| 1613                        | C6-3        | 10.00         | 3          | 4.0                | 113        | 15.30 | 3.4             | 1.60           | 0.83 | 23.4              | 0.43              | 12.2                  | 3 | \$11.79 |
| 1614                        | C6-5        | 10.00         | 5          | 4.0                | 113        | 15.30 | 3.4             | 1.60           | 0.85 | 24.0              | 0.43              | 12.2                  | 3 | \$11.79 |
| 1522                        | C11-3       | 10.00         | 3          | 6.0                | 170        | 22.10 | 4.9             | 0.80           | 1.13 | 32.1              | 0.44              | 12.4                  | 2 | \$7.99  |
| 1523                        | C11-5       | 10.00         | 5          | 5.0                | 142        | 22.10 | 4.9             | 0.80           | 1.18 | 33.4              | 0.44              | 12.4                  | 2 | \$7.99  |
| 1566                        | D12-3       | 20.00         | 3          | 14.0               | 396        | 32.90 | 7.4             | 1.60           | 1.57 | 44.5              | 0.85              | 24.2                  | 2 | \$11.99 |
| 1567                        | D12-5       | 20.00         | 5          | 10.0               | 283        | 30.60 | 7.4             | 1.60           | 1.61 | 45.7              | 0.85              | 24.2                  | 2 | \$11.99 |
| 1692                        | E12-4       | 30.00         | 4          | 17.0               | 482        | 30.60 | 6.9             | 2.70           | 2.16 | 61.2              | 1.3               | 36.9                  | 3 | \$23.99 |
| 1693                        | E12-6       | 29.50         | 6          | 14.0               | 397        | 29.60 | 6.7             | 2.70           | 2.23 | 63.2              | 1.3               | 36.9                  | 3 | \$23.99 |
| 1651                        | F15-4       | 49.61         | 4          | 21.0               | 595        | 25.26 | 5.7             | 3.45           | 3.59 | 101.5             | 2.12              | 60                    | 2 | \$26.99 |
| 1652                        | F15-6       | 49.61         | 6          | 17.0               | 482        | 25.26 | 5.7             | 3.45           | 3.66 | 103.7             | 2.12              | 60                    | 2 | \$26.99 |
| 1696                        | E16-4       | 33.68         | 4          | 20.0               | 566        | 26.44 | 5.9             | 2.09           | 2.86 | 81.0              | 1.41              | 40                    | 2 | \$22.99 |
| 1697                        | E16-6       | 33.68         | 6          | 16.0               | 453        | 26.44 | 5.9             | 2.09           | 2.92 | 82.7              | 1.41              | 40                    | 2 | \$22.99 |

## MODEL ROCKET ENGINE PERFORMANCE CHART CONTINUED

| Prod. No.   | Engine Type | Total Impulse | Time Delay | Est. Max. Lift Wt. | Max Thrust |       | Thrust Duration | Initial Weight |      | Propellant Weight | Quantity per Pack | Retail Price per Pack |   |         |
|---|-------------|---------------|------------|--------------------|------------|-------|-----------------|----------------|------|-------------------|-------------------|-----------------------|---|---------|
|   |             |               |            |                    | Newtons    | lbs   |                 | oz             | g    |                   |                   |                       |   |         |
| <b>UPPER STAGE ENGINES</b>  |             |               |            |                    |            |       |                 |                |      |                   |                   |                       |   |         |
| 1504  | 1/2A3-4T    | 1.25          | 4          | 1.0                | 28         | 8.30  | 1.9             | 0.30           | 0.23 | 6.6               | 0.07              | 1.9                   | 4 | \$10.29 |
| 1599  | A8-5        | 2.50          | 5          | 2.0                | 57         | 13.30 | 3.0             | 0.50           | 0.55 | 15.7              | 0.14              | 4.1                   | 3 | \$10.29 |
| 1607  | B6-6        | 5.00          | 6          | 2.5                | 71         | 12.10 | 2.7             | 0.80           | 0.64 | 18.2              | 0.23              | 6.5                   | 3 | \$10.79 |
| 1615  | C6-7        | 10.00         | 7          | 2.5                | 71         | 15.30 | 3.4             | 1.60           | 0.85 | 24.3              | 0.43              | 12.2                  | 3 | \$11.79 |
| 1524  | C11-7       | 10.00         | 7          | 4.0                | 113        | 22.10 | 4.9             | 0.80           | 1.19 | 33.8              | 0.44              | 12.4                  | 2 | \$7.99  |
| 1568  | D12-7       | 20.00         | 7          | 8.0                | 226        | 32.90 | 7.4             | 1.60           | 1.62 | 46.0              | 0.85              | 24.2                  | 2 | \$11.99 |
| 1694  | E12-8       | 29.80         | 8          | 12.0               | 340        | 31.80 | 7.1             | 2.70           | 2.24 | 63.5              | 1.3               | 36.9                  | 3 | \$23.99 |
| 1653  | F15-8       | 49.61         | 8          | 15.0               | 425        | 25.26 | 5.7             | 3.45           | 3.69 | 104.4             | 2.12              | 60                    | 2 | \$26.99 |
| 1698  | E16-8       | 33.68         | 8          | 14.0               | 396        | 26.44 | 5.9             | 2.09           | 2.99 | 84.7              | 1.41              | 40                    | 2 | \$22.99 |
| <b>BOOSTER STAGE ENGINES</b>  |             |               |            |                    |            |       |                 |                |      |                   |                   |                       |   |         |
| 1510  | A10-0T      | 2.50          | NONE       | 4.0                | 113        | 13.00 | 2.9             | 0.80           | 0.24 | 6.8               | 0.12              | 3.5                   | 4 | \$10.29 |
| 1600  | A8-0        | 2.50          | NONE       | 3.0                | 85         | 13.30 | 3.0             | 0.30           | 0.47 | 13.5              | 0.14              | 4.1                   | 3 | \$10.29 |
| 1608  | B6-0        | 5.00          | NONE       | 4.0                | 113        | 12.10 | 2.7             | 0.80           | 0.55 | 15.7              | 0.23              | 6.5                   | 3 | \$10.79 |
| 1616  | C6-0        | 10.00         | NONE       | 4.0                | 113        | 15.30 | 3.4             | 1.60           | 0.76 | 21.4              | 0.43              | 12.2                  | 3 | \$11.79 |
| 1521  | C11-0       | 10.00         | NONE       | 6.0                | 170        | 22.10 | 4.9             | 0.80           | 1.03 | 29.2              | 0.44              | 12.4                  | 2 | \$7.99  |
| 1565  | D12-0       | 20.00         | NONE       | 14.0               | 396        | 32.90 | 7.4             | 1.60           | 1.43 | 40.4              | 0.84              | 23.8                  | 2 | \$11.99 |
| 1691  | E12-0       | 28.80         | NONE       | 16.0               | 454        | 31.30 | 7.0             | 2.60           | 2.05 | 58.1              | 1.3               | 36.9                  | 3 | \$23.99 |
| 1650  | F15-0       | 49.61         | NONE       | 19.0               | 539        | 25.26 | 5.7             | 3.45           | 3.32 | 94.0              | 2.12              | 60                    | 2 | \$26.99 |
| 1695  | E16-0       | 33.68         | NONE       | 18.0               | 509        | 26.44 | 5.9             | 2.09           | 2.58 | 73.2              | 1.41              | 40                    | 2 | \$22.99 |
| <b>PLUGGED ENGINES--FOR USE WITH ROCKET-POWERED RACERS &amp; R/C ROCKET GLIDERS</b> |             |               |            |                    |            |       |                 |                |      |                   |                   |                       |   |         |
| 1505  | A10-PT      | 2.50          | NONE       | 3.0                | 85         | 13.00 | 2.9             | 0.80           | 0.26 | 6.83              | 0.13              | 3.5                   | 4 | \$10.29 |

The data listed above is from randomly chosen production samples.  
NOTE: The "r" designates a mini-engine.



**WARNING:**  
This product can expose you to silica, which is known to the State of California to cause cancer. For more information go to [www.P65Warnings.ca.gov](http://www.P65Warnings.ca.gov).

This warning is on all Estes engine packaging.



# ESTES MODEL ROCKET ENGINES

The famous model rocket engines that made model rocketry the great activity it is today. Estes model rocket engines have been proven consistent and reliable in more than 500,000,000 launches.

- The concept of a factory assembled model rocket engine is the foundation of this scientific and educational activity!
- 3% of all Estes engines are static-tested at the factory for reliability and adherence to performance specifications.
- All engines comply with the code requirements of the National Fire Protection Association and are certified by the National Association of Rocketry.

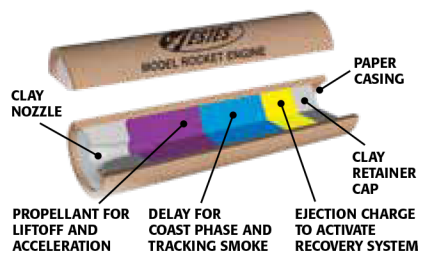

## HOW DOES A MODEL ROCKET ENGINE WORK?

- When engine is ignited, it produces thrust and boosts rocket into sky.
- After propellant is used up, delay is activated, producing tracking smoke and allowing rocket to coast.
- After delay, ejection charge is activated, deploying recovery system.

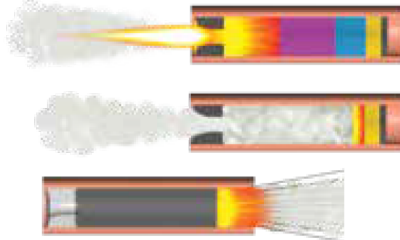

## WHAT SIZES ARE AVAILABLE?

Estes engines are available in a wide variety of sizes and power levels:

| TYPE | TOTAL IMPULSE | ENGINE TYPES   |
|------|---------------|----------------|
| 1/4A | 0.313 - 0.625 | Mini           |
| 1/2A | 0.626 - 1.25  | Standard, Mini |
| A    | 1.26 - 2.50   | Standard, Mini |
| B    | 2.51 - 5.00   | Standard       |
| C6   | 5.01 - 10.00  | Standard       |
| C11  | 5.01 - 10.00  | D Size         |
| D    | 10.01 - 20.00 | D Size         |
| E    | 20.01 - 30.00 | E Size         |
| F    | 45.01 - 50.00 | F Size         |

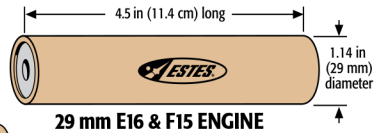
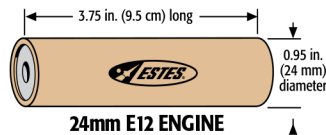
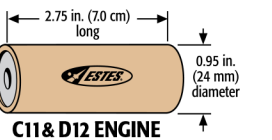
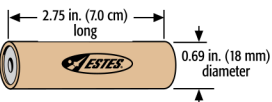
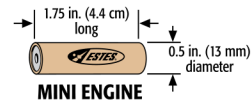

## Each engine type is color coded.

- Single Stage - Green**
- Upper Stage - Purple** (Upper stage engines can be used as single stage engines in lightweight rockets.)
- Booster - Red** (Booster engines contain no delay or ejection charge.)
- Plugged - Blue** (Plugged engines are used for R/C gliders and contain no delay or ejection charge.)

## Each engine has an alphanumeric code printed on it



**B = TOTAL IMPULSE**  
This letter is the total power (in Newton-seconds) produced by the engine. Each succeeding letter has up to twice the total power as the previous letter. (Example: "B" engines have up to twice the power of "A" engines, which results in approximately twice the altitude the rocket will reach.)

**6 = AVERAGE THRUST**  
This number shows the engine's average push or how fast the engine powers the rocket to go. The higher the number, the faster the speed. It is measured in Newtons (4.45 Newtons = 1 lb.).

**4 = TIME DELAY**  
This number gives you the time delay in seconds between the end of the thrust phase and ignition of the ejection charge. Engine types ending in "0" have no time delay or ejection and are used for booster stages and special purposes only. Engines ending in "P" have no time delay or ejection charge and the forward end is plugged.

## ENGINE TIME/THRUST CURVES

- Time/thrust curves are representative of random production samples
- Graphs are not drawn to the same scale

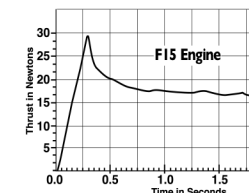
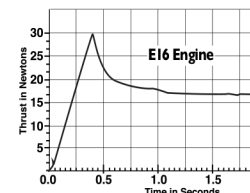
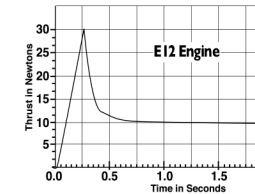
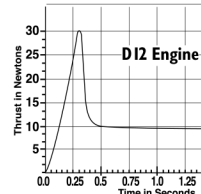
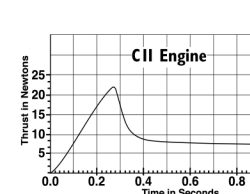
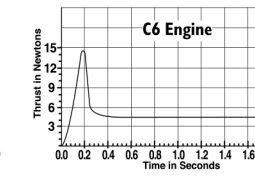
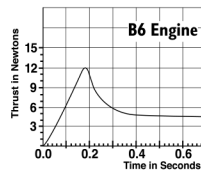
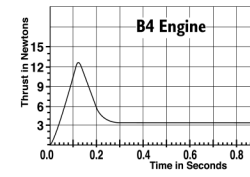
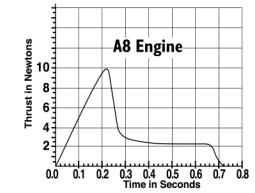
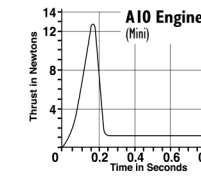
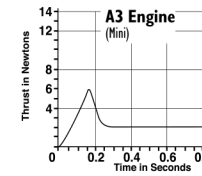
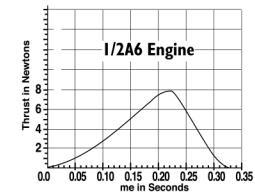
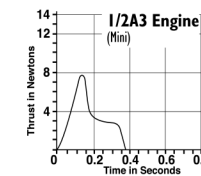
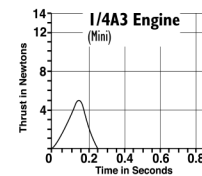
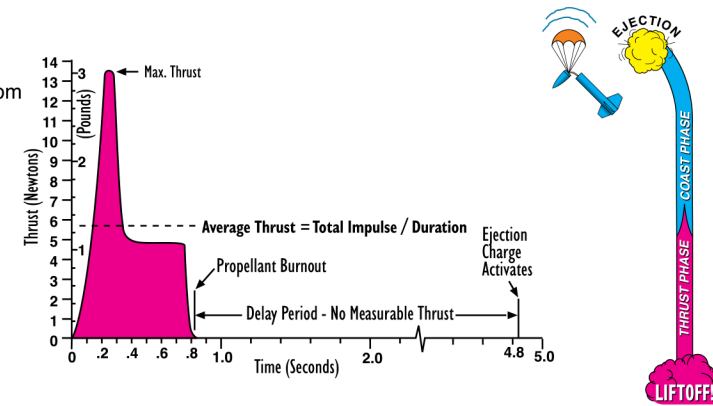



**Take your rocketry hobby  
to the next level with Estes**

***accessories!***

**The key** to any successful rocket launch, whether it's a full-size rocket or a flying model rocket, is the accuracy with which the rocket is assembled. To accomplish this task, full-size rocket companies utilize many assembly jigs and fixtures to ensure accurate alignment of critical components. Here at Estes, we do our best to provide our rocketeer customers with useful jigs, fixtures, and templates for accurate alignment and assembly of our model rocket kits. In addition, we have a variety of useful tools and accessories that can make your model rocket building experience truly enjoyable. And equally important, the accuracy these tools provide will assure that your rocket performs at its ultimate potential.

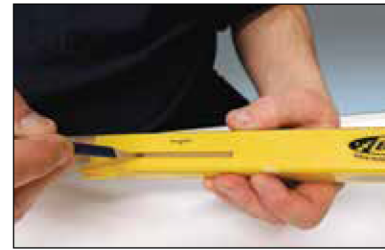

The Tube Marking Guide allows for accurate and consistent fin placement when building your rocket.

Set of 3 different building tools!



Marking Guide

**2227 Tube Marking Guide**  
The tube marking guide is an easy way to mark your fin and launch lug placement. The marking guide is a must for any rocket builder!

**\$12.99**

The Ultimate Tube Marking Guide helps mark body tubes of all different sizes.

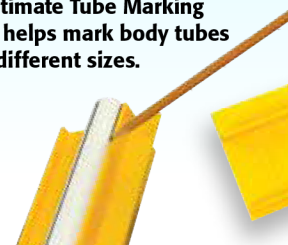

**2228 Ultimate Tube Marking Guide**  
Accurately mark your body tubes for a variety of rocket-assembly purposes.

**\$11.99**



**2315 Tube Cutting Guides**  
Assorted sizes: BT-5, BT-20, BT-50, BT-55, and BT-60 (hobby knife not included)

**\$11.99**



The Tube Cutting Guides come in different sizes and allow for straight and even lines when cutting and marking your body tubes.



## BODY TUBE PACKS

High quality spiral wound paper tubes. Use tube couplers to connect tubes of the same diameter. Outer diameters listed. (not all body tube sizes shown)

3084 • BT-5 • 0.54 in./14 mm diameter • 18 in./45.7 cm long (4 pack) **\$7.49**

3085 • BT-20 • 0.74 in./19 mm diameter • 18 in./45.7 cm long (4 pack) **\$8.49**

3086 • BT-50 • 0.98 in./25 mm diameter • 18 in./45.7 cm long (3 pack) **\$8.49**

3087 • BT-55 • 1.33 in./34 mm diameter • 18 in./45.7 cm long (3 pack) **\$8.99**

3089 • BT-60 • 1.60 in./41 mm diameter • 18 in./45.7 cm long (3 pack) **\$9.49**

3090 • BT-80 • 2.60 in./66 mm diameter • 14 in./45.7 cm long (2 pack) **\$8.99**



3176 BT-5, BT-20, BT-50 Tube Couplers  
(2 each) **\$3.99**



3177 BT-55, BT-60 Tube Couplers  
(2 each) **\$5.49**



3178 BT-80 Tube Couplers  
(2 each) **\$4.99**



### 2320 Launch Lug Pack

Contains 4 each: 1/8 x 2 3/8 in (3 x 60 mm), 1/8 x 1 1/4 in. (3 x 32 mm), 3/16 x 2 in. (5 x 51 mm) and 1/4 x 1 in (6 x 25 mm) launch lugs

**\$5.99**

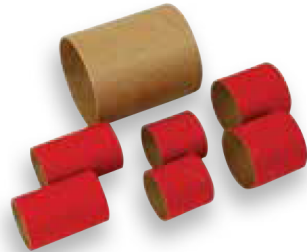

### 3196 Large Tube Coupler Pack

Includes two couplers for BT-55, BT-56 and BT-60; One for BT-80

**\$6.99**



9750 PS II™ 29 mm  
Engine Retainer Set (2 sets)  
**\$8.99**



9751 24 mm  
Engine Retainer Set (2 sets)  
**\$7.99**



3187 18 mm  
Engine Retainer Set (3 sets)  
**\$6.99**

**For complete size and specifications  
of all these parts, go to [estesrockets.com](http://estesrockets.com).**



3175 BT-5 through BT-55 Centering Ring Assortment  
**\$5.99**



3171 Clear Payload Assortment  
**\$17.99**



2278 Shock Cords & Mount Pack  
Includes three 1/8 in. x 36 in. (3 mm x 914 mm) and one 1/4 in. x 36 in. (6 mm x 914 mm) rubber shock cords (enough for four shock cords). Includes shock cord mounts and instructions.

**\$5.99**



3180 Clay Nose Cone Weights  
**\$5.99**

## NOSE CONE ASSORTMENTS

Each package of nose cones may contain a variety of shapes. Some are one piece, others two piece. All have eyelets for shock cord and shroud line attachments.

3160 NC-5 Nose Cone Assortment (5 pack) **\$5.49**

3161 NC-20 Nose Cone Assortment (4 pack) **\$5.49**

3162 NC-50 Nose Cone Assortment (5 pack) **\$8.99**

3163 NC-55 Nose Cone Assortment (4 pack) **\$7.99**

3164 NC-56 Nose Cone Assortment (4 pack) **\$7.99**

3165 NC-60A Nose Cone Assortment (3 pack) **\$8.99**

3168 NC-80B Nose Cone (1 Pack) **\$4.49**

3173 Sci-Fi Nose Cone Assortment (5 pack) **\$16.99**







**3181 Engine Mount Parts Assortment**  
3 each engine mounts for mini-engines, standard engines, and D engines.  
**\$8.49**



**2316 Mini to Standard Engine Adapters**  
Two simple steps transform a mini-engine into a standard size. Insert a mini-engine into the adapter, and insert the adapter into a rocket. 3 adapters per pack. Reusable. (Engines not included.) **\$5.99**



**2317 Standard to D Engine Adapters**  
Two simple steps transform a standard engine into a D size. Insert a standard engine into the adapter, and insert the adapter into a rocket. 3 adapters per pack. Reusable. (Engines not included.) **\$5.99**



**2274 Recovery Wadding**  
Flame-resistant wadding protects recovery system. Required in most Estes rockets. Contains approximately 72 sheets – enough for about 18-25 flights!  
**\$5.49**

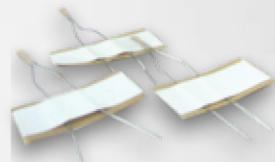

**2302 Model Rocket Starters**  
Easy-to-use Estes starters in a convenient six pack. It's always good to have spares.  
**\$5.49**

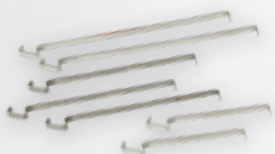

**3143 Engine Hook Accessory Pack**  
Hooks fit mini engines (two), regular and D engines (three) and E12 engines (two).  
**\$5.49**

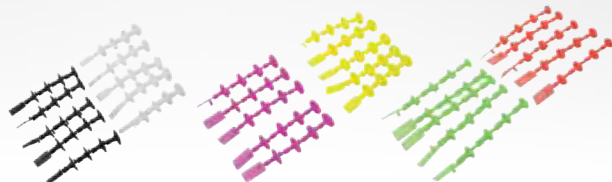

2250 1/4A3, 1/2A3, A3 and A10 Engine Plugs (20 pack) **\$5.99**  
2251 1/2A6, A8, B4, B6, and C6 Engine Plugs (20 pack) **\$5.99**  
2252 C11, D12, E9, E12, E16 and F15 Engine Plugs (20 pack) **\$5.99**



**3158 Standard Engine Mount Kit**  
Fits BT-50, 55 and 60 tubes. Can also be used to make a conversion mount for lightweight D powered rockets.  
**\$7.49**



**3170 Waterslide Decal Set**  
**\$12.99**



**3179 2x Laser Cut Centering Rings and 2x Shroud Templates**  
**\$8.49**



**3159 D and E12 Engine Mount Kit**  
Heavy duty engine mounts for D and E12 engines. Fits BT-55, 60 and 80 tubes.  
**\$10.99**

# How High Did It Fly?

1,200'  
1,100'  
1,000'  
900'  
800'  
700'  
600'  
500'  
400'  
300'  
200'  
100'  
0'

**Altitrak:** The single most often asked question regarding launching a model rocket is; how high did it fly? Human estimation of heights can range from awful to "Who Knows?" However, fairly accurate measurement of the maximum launch height is possible. Over the years, model rocketeers have most often used one of two methods (geometric or electronic based) to measure altitude.

The geometric process requires a baseline (or leg of a right triangle) from the launch pad and a protractor-based instrument like the Estes Altitrak, it is used to determine the maximum height at apogee of the rocket.

The geometric method requires a team approach (usually a launcher and a helper). After the launcher places the rocket on the pad, the helper with Altitrak in hand, paces off 300 feet from the launch pad. As the launcher begins the countdown, the helper lines up the crosshair of the Altitrak on the rocket and pulls the trigger. At ignition the helper follows the flight path of the rocket in the crosshair and releases the trigger when the rocket reaches apogee. The Altitrak swing arm aligns with numbers that are painted on the side of the Altitrak. The helper reads the number from the Altitrak, which is displayed as height in meters and can be converted to feet by multiplying meters by 0.3048.



**2232 Altitrak™**  
Measure altitude with this easy to use device. Follow the rocket in the sights to apogee, and release the trigger to lock the reading.  
**\$21.99**

Now you can know!

**Altimeter:** Another method for measuring the altitude without the need for a helper is by using the electronic Altimeter. These onboard electronic devices can attach to the nose cone or be inserted into a payload bay. Altimeters incorporate a highly sensitive barometric sensor and an electronic triggering logic that provides maximum altitude at apogee.



**2246 Altimeter**  
Record up to 10 flights. LCD display, battery included.  
**\$39.99**

The Estes 2246 Electronic Altimeter provides a direct LCD readout and can record heights in one-foot increments up to 10,000 feet (+/- 3 feet) and can store up to 10 launches in the unit's memory. The Estes Altimeter weighs about 1/2 oz. and is slightly over 5/8" in. in diameter.

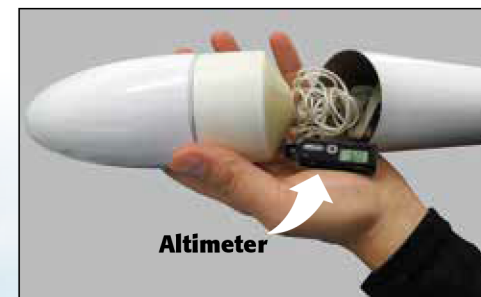

The Altimeter hooks onto the nose cone of your rocket and is inserted into the body tube right above the parachute. As your rocket climbs in altitude, the Altimeter digitally calculates the maximum height attained.

The hand-held Altitrak quickly tells how high your rocket flies!





**2222 Porta-Pad® II Launch Pad with Electron Beam® Launch Controller**

Quick assembly - no glue or tools required! Launch rod angle is adjustable. Comes complete with blast deflector, standoff, two-piece 1/8 in. (3 mm) launch rod and safety cap. Can accommodate a 3/16 in. (5 mm) Maxi™ launch rod - not included. Launch controller comes assembled with safety key and 15 ft. (4.6 m) of cable. Requires 4 new 1.5V AA alkaline batteries - not included.

**\$29.99**

**Sold Separately**

**2215 Porta Pad® II Launch Pad**  
**\$21.99**

**Sold Separately**

**2220 Electron Beam® Launch Controller**  
**\$24.99**



**2243 1/8 in. (3 mm) Two-Piece Launch Rod**  
Replacement rod ideal for most rockets.  
**\$6.99**

**2244 3/16 in. (5 mm) Two-Piece Maxi™ Launch Rod**  
Launch rod with extra strength and length for larger rockets.  
**\$11.99**



**2241 Blast Deflector Plate**  
Replaces that worn-out deflector. For use with Porta Pad II PN 2215  
**\$5.99**



**2230 E™ Launch Controller**  
Comes assembled with safety key and 30 ft. (9 m) of cable. Requires 4 new 1.5V AA alkaline batteries - not included.  
**\$32.99**



**2238 Porta-Pad® E Launch Pad**  
Quick assembly - no glue or tools required. Launch rod angle is adjustable. Includes a 1/4 in (6 mm) launch rod, but can accommodate a 3/16 in. (5 mm) Maxi™ launch rod - not included.  
**\$30.99**

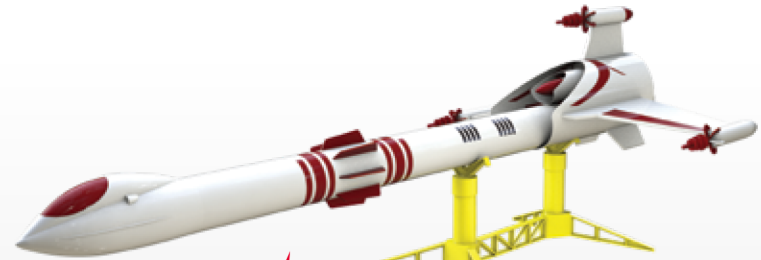

**2290 Rocket Display Stand**  
For mini-engine rockets (3 pack)  
**\$7.49**



**2293 Rocket Display Cradle**  
Multiple ways to use: Assembly, display or transportation to the field  
**\$8.49**



**2291 Rocket Display Stand**  
For standard engine rockets (3 pack)  
**\$7.49**



**2292 Rocket Display Stand**  
For C-11, D, and E engine rockets (3 pack)  
**\$7.49**

**Never misalign your rocket fins again; use the Estes Fin Alignment Guide!**



**2231 Fin Alignment Guide**  
Fast and accurate fin alignment for three- or four-finned rockets.  
**\$21.99**

# Recovery parachutes

2268 9 in. (22.9 cm) Parachute \$3.49

2262 6 in. (15.2 cm) Parachute \$2.99

2264 12 in. (30.5 cm) Parachute \$3.99

2265 15 in. (38.1 cm) Parachute \$4.49

2267 18 in. (45.7 cm) Parachute \$4.99

2271 24 in. (61 cm) Parachute \$5.49

All parachutes are fully-assembled

Sturdy sewn fabric chutes for your biggest, heaviest rockets.



2261 24 in. (61 cm) Nylon Parachute \$12.99

2273 30 in. (76.2 cm) Nylon Parachute \$16.99

*Challenge your imagination!*



Contains 100+ parts. Design and build the rockets of your dreams!

Experiment with your own designs. Includes enough parts to build at least 8 complete rockets. Just add imagination.

1980 Designer's Special™ \$86.99

Designs shown are for inspiration only and may include other imaginative parts not included in your Designer's Special.







## EXPLORE IT, ENGINEER IT, LAUNCH IT!

Inspiring students, young and old – that’s the focus of Estes Education! Log onto [Estesrockets.com/education](http://Estesrockets.com/education) to find everything you need for your classroom or youth organization.

### Estes Makes it EASY!

“ Building Estes model rockets is the best hands-on activity I have ever done with kids. ”

Mary Roberts,  
longtime Estes employee  
& former 4-H rocketry leader



## TEACHING WITH ESTES ROCKETRY IS REAL-WORLD STEM

### Estes Curriculum & Lesson Plans Include:

- NGSS standards
- 3-D Practices, Core Ideas, Crosscutting
- **Engage:** Interact with STEM curriculum with proven methods.
- **Explore:** Use authentic materials to engineer and experience the model rocket phenomenon with crosscutting adventures.
- **Explain:** Students gather data and summarize experiences by interpreting results and communicating possible improvements, successes and challenges.
- **Elaborate:** Take the student’s understanding to the next level, digging deeper, reaching higher, applying concepts in self-directed learning.
- **Evaluate:** Students evaluate their engineering design process and scientific explorations relating to real-world applications.

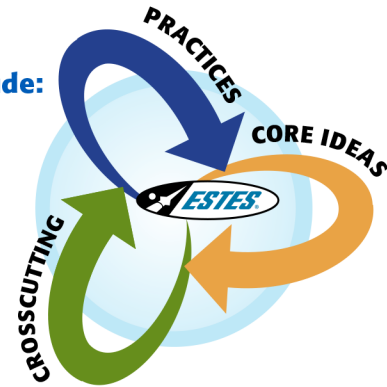

## FREE ONLINE RESOURCES

At [EstesRockets.com/education](http://EstesRockets.com/education) you can find useful information about:

### ■ Classroom Activities:

- Close reading
- Journaling
- Games

### ■ Model Rocket Basics for:

- Youth Groups
- Homeschooling
- Enrichment

### ■ How to Choose a Launch Site

### ■ Videos, Animation, and More!

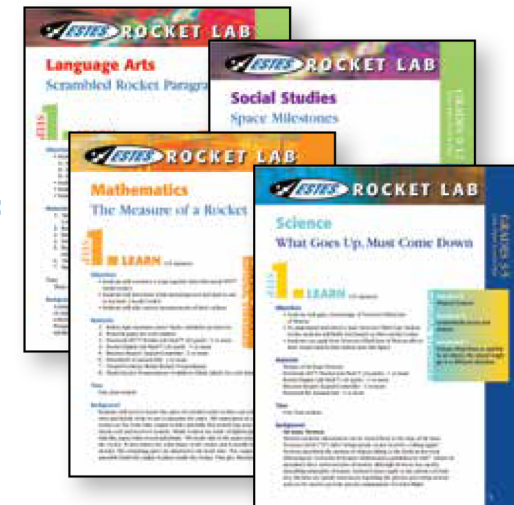

# SPECIAL BULK PACKS FOR EDUCATORS

Estes offers 12-piece rocket bulk packs especially for educators and youth group leaders. (Rocket engines, recovery wadding, starters, and engine plugs are sold separately.)



## HOW TO CHOOSE THE RIGHT ROCKET FOR YOUR GROUP

Consider these four things when making your plan

### Age

Younger kids (Grades 5-8) need rockets that are simpler to assemble. They're not quite ready for the challenge of gluing on individual fins yet, so choose one of our kits with a one-piece plastic fin unit and fewer assembly steps. Older kids do a better job of reading, understanding and following assembly instructions. They will have the hand-eye skills to glue wood fins to the body tube.

### Staff

Conducting a build session with 30 kids yourself is a challenge. We recommend that you get helpers for both your build session and on your launch. Short on adult volunteers? Recruit kids from higher grade levels.

### Time

Do you have a single session to both build and fly the rocket? Consider the amount of time needed for glue to dry and how much time it will take to prep the rockets before launch.

### Flying Field Size

Recovery method (parachute or streamer), engine size (A, B, C) and wind all play a role in what rocket is best suited for the size field you may have. You can't make your field bigger, but you can choose the right size rocket to fly on it!

Parachutes drift farther and come down slower, so you'll need a bigger field.

Streamers have very little drift and mostly come down within a small radius of your launch pad.

Rocket engines double in power with each succeeding engine letter. For example: B engines effectively fly your rocket twice as high as A engines.

# THESE ARE OUR EASIEST TO BUILD ROCKETS



**Gnome Bulk Pack** \$69.<sup>99</sup>

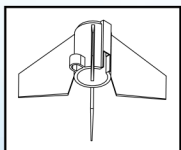

**1749 Gnome™ (12-pack)**  
 Length: 10.3 in. (26.2 cm)  
 Recovery: 12 in. (30.5 cm) Streamer  
 Fin Type: Plastic  
 Recommended Engines: 1/2A3-4T for first launch; 1/2A3-2T, 1A3-4T, A10-3T

Streamer Recovery

One-piece molded fin unit.



**12 ROCKETS INCLUDED!**



**Alpha III Bulk Pack** \$129.<sup>99</sup>

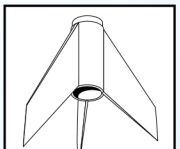

**1751 Alpha III® (12-pack)**  
 Length: 12.1 in. (30.7 cm)  
 Recovery: 12 in. (30.5 cm) Parachute  
 Fin Type: Plastic  
 Recommended Engines: A8-3 for first launch; 1/2A6-2, A8-5, B4-4, B6-4, B6-6, C6-5, C6-7

Parachute Recovery

One-piece molded fin unit.



**12 ROCKETS INCLUDED!**

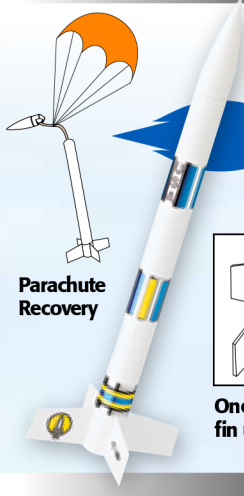

**Generic Bulk Pack** \$114.<sup>99</sup>

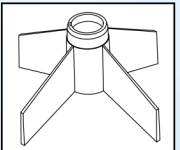

**1764 Generic E2X® (12-pack)**  
 Length: 13.5 in (34.3 cm)  
 Recovery: 12 in. (30.5 cm) Parachute  
 Fin Type: Plastic  
 Recommended Engines: A8-3 for first launch; 1/2A6-2, A8-5, B4-4, B6-4, B6-6, C6-5, C6-7

Parachute Recovery

One-piece molded fin unit.



**12 ROCKETS INCLUDED!**



## ASSORTED BULK PACK INCLUDES 3 STYLES OF ROCKETS!

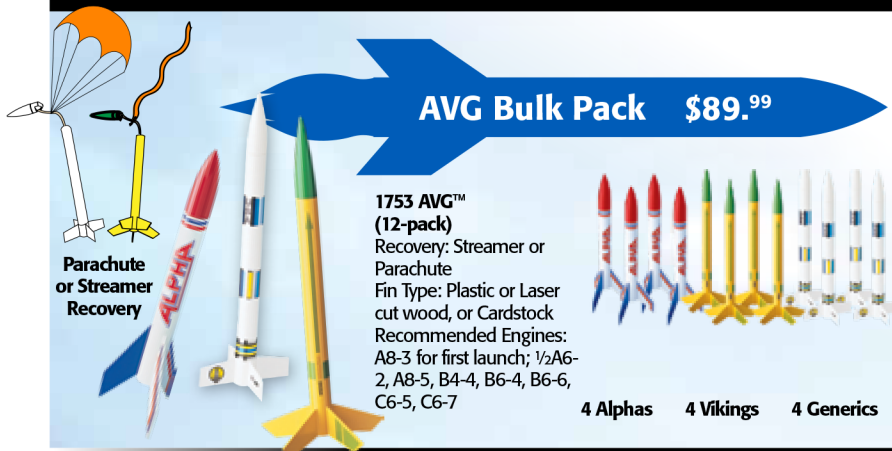

**Parachute or Streamer Recovery**

**AVG Bulk Pack \$89.99**

**1753 AVG™ (12-pack)**  
 Recovery: Streamer or Parachute  
 Fin Type: Plastic or Laser cut wood, or Cardstock  
 Recommended Engines: A8-3 for first launch; 1/2A6-2, A8-5, B4-4, B6-4, B6-6, C6-5, C6-7

4 Alphas 4 Vikings 4 Generics

12-PACK WITH 4 OF EACH ROCKET!



**Streamer Recovery**

**Firestreak Bulk Pack \$104.99**

**1794 Firestreak SST™ (12-pack)**  
 Length: 10.2 in. (25.9 cm)  
 Quick Snap – No gluing!  
 Recovery: 12 in. (30.5 cm) Streamer  
 Fin Type: Plastic  
 Recommended Engines: 1/2A3-2T for first launch; 1/2A3-4T, A3-4T, A10-3T

Four separate molded fins that snap into body tube.

12 ROCKETS INCLUDED!

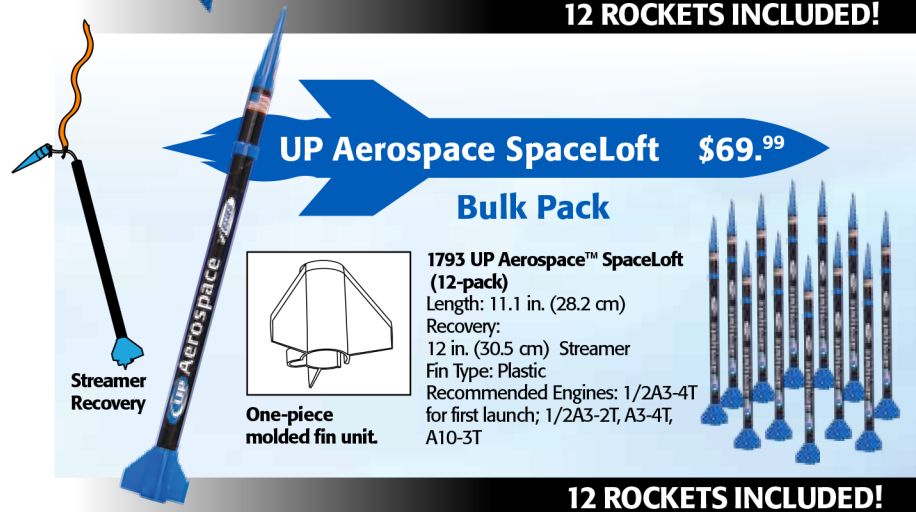

**Streamer Recovery**

**UP Aerospace SpaceLoft Bulk Pack \$69.99**

**1793 UP Aerospace™ SpaceLoft (12-pack)**  
 Length: 11.1 in. (28.2 cm)  
 Recovery: 12 in. (30.5 cm) Streamer  
 Fin Type: Plastic  
 Recommended Engines: 1/2A3-4T for first launch; 1/2A3-2T, A3-4T, A10-3T

One-piece molded fin unit.

12 ROCKETS INCLUDED!

## These Rockets Are More Challenging To Build

They can be built in two hours or less. Fins must be glued to the body tube and this requires dry time before launch. Painting and finishing will take more time.

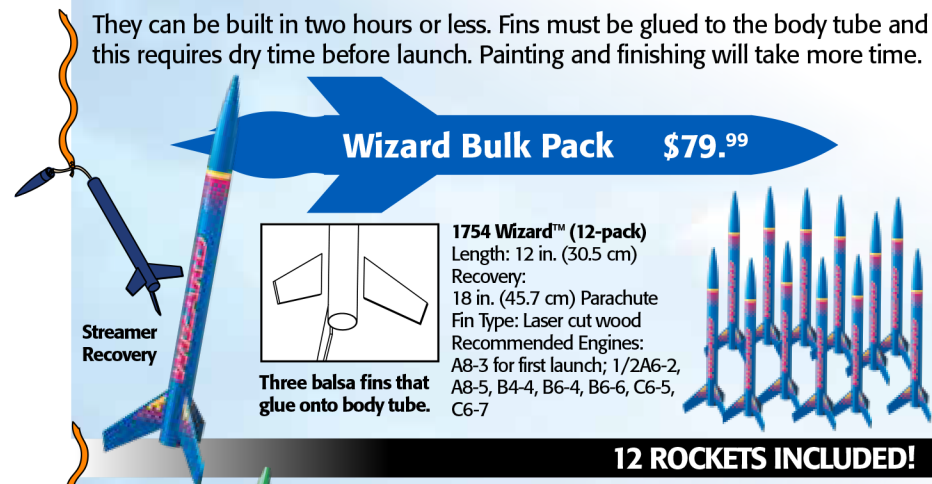

**Streamer Recovery**

**Wizard Bulk Pack \$79.99**

**1754 Wizard™ (12-pack)**  
 Length: 12 in. (30.5 cm)  
 Recovery: 18 in. (45.7 cm) Parachute  
 Fin Type: Laser cut wood  
 Recommended Engines: A8-3 for first launch; 1/2A6-2, A8-5, B4-4, B6-4, B6-6, C6-5, C6-7

Three balsa fins that glue onto body tube.

12 ROCKETS INCLUDED!

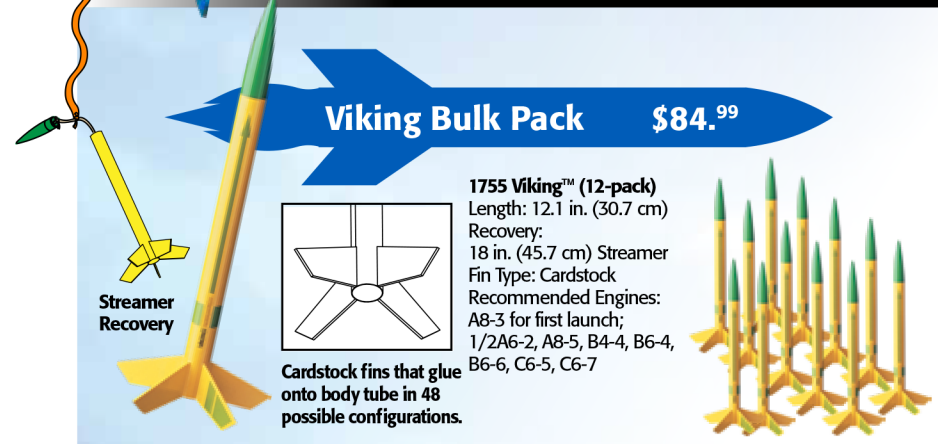

**Streamer Recovery**

**Viking Bulk Pack \$84.99**

**1755 Viking™ (12-pack)**  
 Length: 12.1 in. (30.7 cm)  
 Recovery: 18 in. (45.7 cm) Streamer  
 Fin Type: Cardstock  
 Recommended Engines: A8-3 for first launch; 1/2A6-2, A8-5, B4-4, B6-4, B6-6, C6-5, C6-7

Cardstock fins that glue onto body tube in 48 possible configurations.

12 ROCKETS INCLUDED!

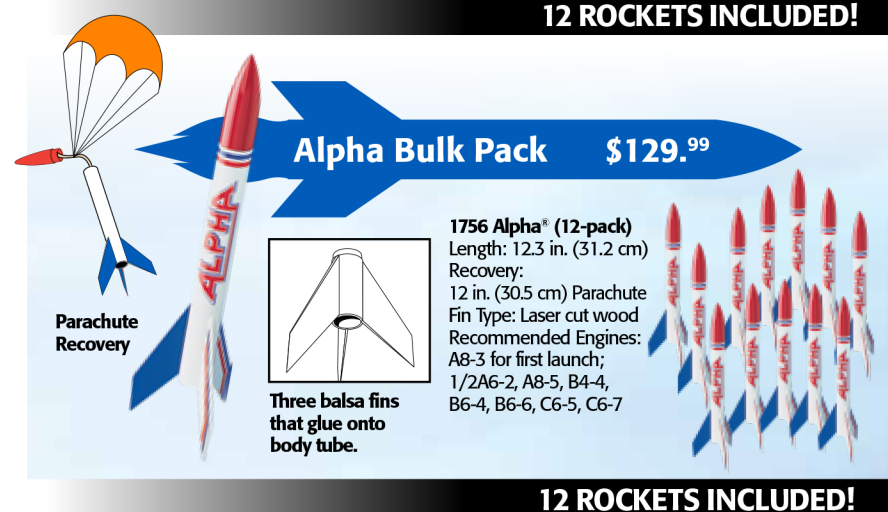

**Parachute Recovery**

**Alpha Bulk Pack \$129.99**

**1756 Alpha® (12-pack)**  
 Length: 12.3 in. (31.2 cm)  
 Recovery: 12 in. (30.5 cm) Parachute  
 Fin Type: Laser cut wood  
 Recommended Engines: A8-3 for first launch; 1/2A6-2, A8-5, B4-4, B6-4, B6-6, C6-5, C6-7

Three balsa fins that glue onto body tube.

12 ROCKETS INCLUDED!

I'm Bug Rogers!  
With the Loadstar II Bulk Pack you can command me and my insectronaut friends on countless off-world adventures!



Parachute Recovery



The Loadstar II comes with a clear nose cone payload and engine booster which can achieve spectacular heights!

**LOADSTAR II BULK PACK \$169.99**

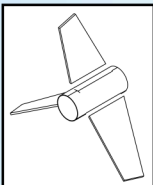

Three balsa fins (six including booster) that glue onto body tube.

**1760 Loadstar™ II (12-pack)**  
Length: 23.3 in. (59.2 cm)  
Recovery: 18 in. (45.7 cm) Parachute  
Fin Type: Laser cut wood  
Recommended Engines: Single Stage: B4-4 for first launch; B6-4 C6-5;  
Two Stage: Booster Stage: B6-0 for first launch; C6-0; Upper Stage: A8-5 for first launch; B6-4, B6-6, C6-7



**12 ROCKETS WITH CLEAR PAY LOAD INCLUDED!**

## ROCKET ENGINE BULK PACKS

Every launch requires engines, recovery wadding, starters and plugs. These convenient engine bulk packs include enough of each for 24 launches. Choose from a variety of engine sizes. We advise using the smallest recommended engine for first launches.

- 1781 A8-3 Engines (24 each); 30 starters; 24 plugs; 72 sheets wadding **\$71.99**
- 1783 B6-4 Engines (24 each); 30 starters; 24 plugs; 72 sheets wadding **\$72.99**
- 1784 B6-0 & B6-6 Engines (12 each); 30 starters; 24 plugs; 72 sheets wadding **\$80.59**
- 1788 1/2 A3-4T Engines (24 each); 30 starters; 24 plugs; 72 sheets wadding **\$57.79**
- 1789 A8-3; B6-4; C6-3; C6-5 Engines (6 each); 30 starters; 24 plugs; 72 sheets wadding **\$84.99**
- 1672 Blast-Off Flight Pack (12 each); 30 starters; 28 plugs; 72 sheets wadding **\$69.99**



Get more Blast Off for your buck with education pricing!



### 1672 Blast-Off® Flight Pack

Includes 6 each of A8-3, B6-4, C6-3, C6-5 engines, 30 starters, 28 starter plugs and 72 sheets of recovery wadding.



## THE LIFETIME LAUNCH SYSTEM IS DESIGNED FOR TEACHERS (Includes Controller & Launch Pad).



**Pro Series II Launch Controller**

### Pro Series II Launch Controller

- **30 ft. (9.1 m) launch cable**
  - Students get a better launch view.
- **Audible Continuity**
  - Students can easily hear if the starter is connected correctly.
- **Two hands required for launch**
  - Even with the safety key left in, the rocket will not launch without both buttons pressed.
- **Requires 6 "C" size alkaline batteries**

### Lifetime Launch System

- **Stands 18 in. (45.7 cm) off the ground!**
  - Students can easily see the starter wires and make a good connection.
- **Tiltable**
  - Students can make last-minute adjustments to the launch angle.
- **Includes 1/8 in. (3 mm) and 3/16 in. (5 mm) two piece launch rods**
  - The rods store inside a pad leg.



**2310  
Lifetime  
Launch System  
\$79.99**

Designed to withstand the rigors of multiple use, the launch pad and launch controller are the best Estes has ever made!

\* The Lifetime Launch System comes with a lifetime limited warranty available to read at [estesrockets.com/lifetime-launch-system-warranty](http://estesrockets.com/lifetime-launch-system-warranty).

## BRING NEXT GENERATION SCIENCE INTO YOUR CLASSROOM

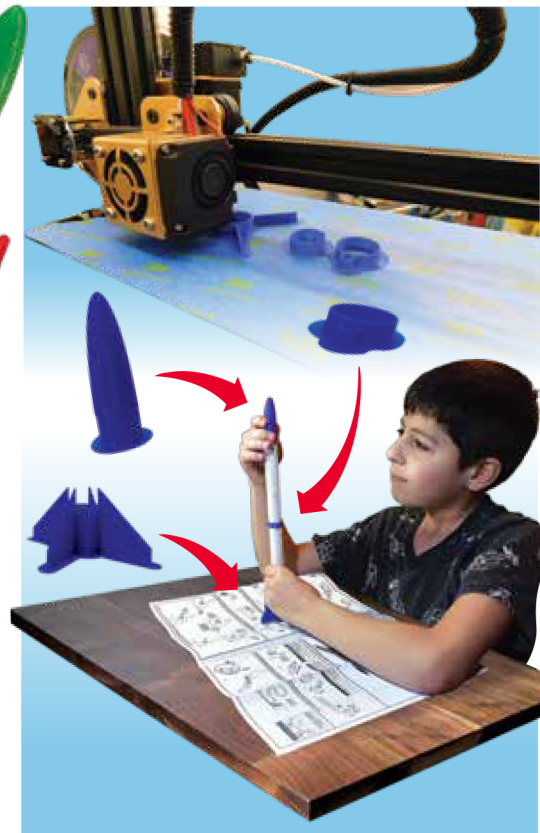
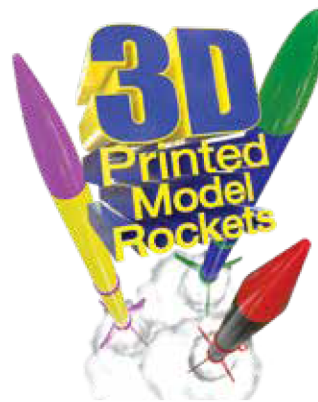

Something new at ESTES! That's right, 3D printed model rockets. Buy the Orbis™ bulk pack and download the .stl files from the Estes website to print your 3D plastic parts, then you are ready to build your rockets! Our parts that you purchase + your parts that you grow = a great learning experience and lots of fun! Nine different designs and simple straightforward assembly! Build 12 rockets!



### 1706 Orbis

Length: 10 - 12 in. (25 - 30.5 cm)  
Diameter: 0.74 in. (19 mm)  
Estimated Weight: 0.76 oz. (21.5 g)  
Fins: 3D Printed  
Recovery: 9 in. (22.9 cm) Parachute  
Projected Altitude: 400 ft (122 m)  
Recommended Engines: A8-3 for first launch; B6-4, C6-5

**\$59.99**

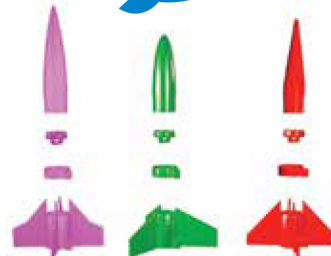

Students actively engage in scientific and engineering practices and apply crosscutting concepts to deepen their understanding of the core ideas in these fields.

Students 3D print these parts!

# PHANTOM



## CLASSROOM DEMONSTRATOR ROCKET

The Phantom is a STEM education tool and is used in classrooms nationwide! It is a great see-through visual aid when demonstrating the various parts of a model rocket to your students!

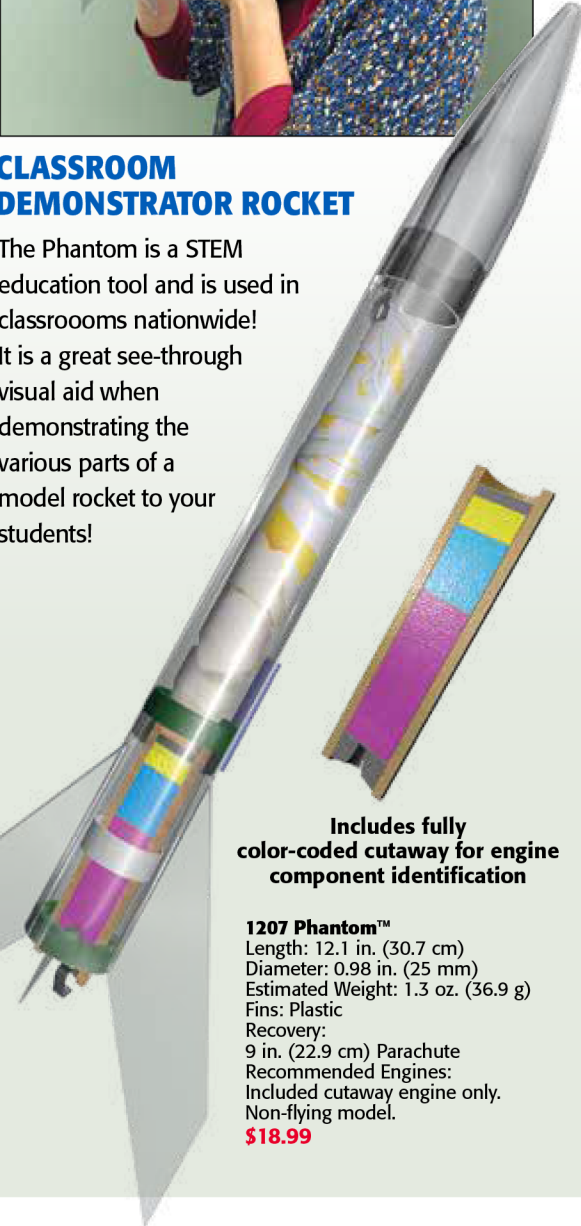

Includes fully color-coded cutaway for engine component identification

**1207 Phantom™**  
Length: 12.1 in. (30.7 cm)  
Diameter: 0.98 in. (25 mm)  
Estimated Weight: 1.3 oz. (36.9 g)  
Fins: Plastic  
Recovery:  
9 in. (22.9 cm) Parachute  
Recommended Engines:  
Included cutaway engine only.  
Non-flying model.  
**\$18.99**



Official Rockets and Engine Supplier for Space Camp!

HUNTSVILLE, ALABAMA

# Celebrate the 50th anniversary of the Apollo 11 moon landing in 2019 with **Space Camp!**

Programs are available for adults, families and children ages 9-18.



**APOLLO 50<sup>th</sup>** NEXT GIANT LEAP  
POWERED BY THE ROCKET CITY  
HUNTSVILLE, ALABAMA

Make plans to join us in 2019 for a fully-immersive astronaut training experience in the birthplace of the Saturn V moon rocket, Huntsville, Alabama.

Visit us online at [spacecamp.com](http://spacecamp.com)

Call 1-800-637-7223 to plan your summer trip now. Prime dates are filling fast!

SpaceCampUSA



*Equipped with his five senses, man explores the universe around him and calls the adventure Science.  
- Edwin Powell Hubble*

### 5302 Rocket Science Starter Set

Discover the fun of science! Build the rocket, launch with one of the three included engines, and observe as a reaction occurs to make the rocket soar! Launch again with a different size engine and measure the difference in altitude.



**Perfect for Science Fairs!**

**5302 ROCKET SCIENCE STARTER SET INCLUDES:**

- 1 Rocket
- 1 Launch Pad
- 1 Launch Controller
- 1 12 in. (30.5 cm) Parachute
- 1 each A8-3, B6-4, C6-5 Single Stage Model Rocket Engine
- 4 Starters
- 8 Plugs
- 12 Sheets of Recovery Wadding
- 1 Altitude Tracker

Length: 12.8 in. (32.5 cm)  
 Diameter: .98 in. (25 mm)  
 Estimated Weight: 1.2 oz. (34 g)  
 Fins: Plastic  
 Recovery: 12 in. (30.5 cm) Parachute  
 Projected Altitude: 1100 ft. (335 m)  
 Recommended Engines: A8-3 for first launch; 1/2A6-2, B4-4, B6-4, B6-6, C6-5, C6-7

**\$34.99**

Labels in the image: ALTITUDE TRACKER, ESTES ALTITUDE TRACKER, ROCKET, 4 STARTERS, LAUNCH PAD, RECOVERY WADDING, 8 PLUGS, COMES WITH A, B, & C ENGINES, PARACHUTE, LAUNCH CONTROLLER.





- 1. Materials.** I will use only lightweight, non-metal parts for the nose, body, and fins of my rocket.
- 2. Motors.** I will use only certified, commercially-made model rocket motors, and will not tamper with these motors or use them for any purposes except those recommended by the manufacturer.
- 3. Ignition System.** I will launch my rockets with an electrical launch system and electrical motor igniters. My launch system will have a safety interlock in series with the launch switch, and will use a launch switch that returns to the "off" position when released.
- 4. Misfires.** If my rocket does not launch when I press the button of my electrical launch system, I will remove the launcher's safety interlock or disconnect its battery, and will wait 60 seconds after the last launch attempt before allowing anyone to approach the rocket.
- 5. Launch Safety.** I will use a count-down before launch, and will ensure that everyone is paying attention and is a safe distance of at least 15 feet away when I launch rockets with D motors or smaller, and 30 feet when I launch larger rockets. If I am uncertain about the safety or stability of an untested rocket, I will check the stability before flight and will fly it only after warning spectators and clearing them away to a safe distance. When conducting a simultaneous launch of more than ten rockets I will observe a safe distance of 1.5 times the maximum expected altitude of any launched rocket.
- 6. Launcher.** I will launch my rocket from a launch rod, tower, or rail that is pointed to within 30 degrees of the vertical to ensure that the rocket flies nearly straight up, and I will use a blast deflector to prevent the motor's exhaust from hitting

- the ground. To prevent accidental eye injury, I will place launchers so that the end of the launch rod is above eye level or will cap the end of the rod when it is not in use.
- 7. Size.** My model rocket will not weigh more than 1500 grams (53 ounces) at liftoff and will not contain more than 125 grams (4.4 ounces) of propellant or 320 N-sec (71.9 pound-seconds) of total impulse.
  - 8. Flight Safety.** I will not launch my rocket at targets, into clouds, or near airplanes, and will not put any flammable or explosive payload in my rocket.
  - 9. Launch Site.** I will launch my rocket outdoors, in an open area at least as large as shown in the accompanying table, and in safe weather conditions with wind speeds no greater than 20 miles per hour. I will ensure that there is no dry grass close to the launch pad, and that the launch site does not present risk of grass fires.

**LAUNCH SITE DIMENSIONS**

| Installed Total Impulse (N-sec) | Equivalent Motor Type | Minimum Site Dimensions (ft.) |
|---------------------------------|-----------------------|-------------------------------|
| 0.00-1.25                       | 1/4A, 1/2A            | 50                            |
| 1.26-2.50                       | A                     | 100                           |
| 2.51-5.00                       | B                     | 200                           |
| 5.01-10.00                      | C                     | 400                           |
| 10.01-20.00                     | D                     | 500                           |
| 20.01-40.00                     | E                     | 1000                          |
| 40.01-80.00                     | F                     | 1000                          |
| 80.01-160.00                    | G                     | 1000                          |
| 160.01-320.00                   | Two Gs                | 1500                          |

- 10. Recovery System.** I will use a recovery system such as a streamer or parachute in my rocket so that it returns safely and undamaged and can be flown again, and I will use only flame-resistant or fireproof recovery system wadding in my rocket.
- 11. Recovery Safety.** I will not attempt to recover my rocket from power lines, tall trees, or other dangerous places.

[www.nar.org](http://www.nar.org)



**A proud sponsor of the Team America Rocketry Challenge**



[rocketcontest.org](http://rocketcontest.org)



[nar.org](http://nar.org)



[aia-aerospace.org](http://aia-aerospace.org)



*Our return policy*

**YOU'RE COVERED WITH THE ESTES FULL ONE-YEAR WARRANTY**

Your Estes model rocket product is warranted against defects in materials or workmanship for one year from the date of the original purchase. If this Estes product, because of a manufacturing mistake, malfunctions or proves to be defective within the one-year warranty period, it will be repaired or replaced, at Estes' option and at no charge to you.

This warranty does not cover incidental or consequential damage to persons or property caused by the use, abuse, misuse, failure to comply with operating instructions or improper storage of the

warranted products. Some states do not allow the exclusion or limitation of incidental or consequential damages, so the above exclusion may not apply to you. This warranty gives you specific legal rights and you may also have other rights which vary from state to state.

For repair or replacement under this warranty, please contact us at [www.estesrockets.com](http://www.estesrockets.com) or by mail at Estes Industries, LLC, Customer Service Department, 1295 H Street, Penrose, Colorado 81240-9698.



## INDEX

### Rockets

|                                    |    |
|------------------------------------|----|
| 3 Bandits™                         | 20 |
| Airborne Surveillance Missile      | 34 |
| Air Walker™                        | 24 |
| Alpha®                             | 25 |
| Alpha® Bulk Pack                   | 87 |
| Alpha III®                         | 26 |
| Alpha III® Bulk Pack               | 73 |
| Alpha III® Launch Set              | 12 |
| Apollo Little Joe II               | 53 |
| Ascender™                          | 64 |
| Astron Explorer™                   | 47 |
| Athena™                            | 19 |
| AVC™ Bulk Pack                     | 86 |
| Baby Bertha™                       | 33 |
| Bandito™                           | 22 |
| Big Bertha™                        | 33 |
| Big Daddy™                         | 60 |
| Black Brant II™                    | 56 |
| Black Brant III™                   | 56 |
| Boosted Bertha™                    | 38 |
| Bull Pup 12D                       | 35 |
| Centuri®                           | 30 |
| Checkmate™                         | 39 |
| Chiller™                           | 23 |
| Citation Patriot™                  | 28 |
| Comanche-3™                        | 40 |
| Conquest™                          | 47 |
| Crossbow SST™                      | 30 |
| Crossfire ISX™                     | 26 |
| Dazzler™                           | 22 |
| Der Red Max™                       | 27 |
| Designer Special™                  | 81 |
| Double Ringer™                     | 43 |
| Dragonite™                         | 21 |
| Eggsaliber™                        | 32 |
| Estes Shuttle™                     | 34 |
| Executioner™                       | 61 |
| Expedition™                        | 46 |
| Explorer Aquarius™                 | 49 |
| Extreme 12™                        | 61 |
| Firehawk™                          | 20 |
| Firestreak™ SST                    | 21 |
| Firestreak SST™ Bulk Pack          | 86 |
| Flash®! Launch Set                 | 14 |
| Flicker™ Launch Set                | 15 |
| Flip Flyer™                        | 43 |
| Flip Flyer™ Launch Set             | 17 |
| Flying Colors™                     | 23 |
| Fractured™                         | 22 |
| Galaxy Glow™                       | 23 |
| Generic E2X®                       | 18 |
| Generic E2X® Bulk Pack             | 85 |
| Gnome™ Bulk Pack                   | 85 |
| Goblin™                            | 29 |
| Hex-3™                             | 27 |
| Hi-Flier®                          | 25 |
| Hi-Flier XL™                       | 61 |
| Honest John                        | 54 |
| Hyper Bat™                         | 38 |
| Indicator™                         | 28 |
| Interceptor                        | 48 |
| Javelin™ Launch Set                | 15 |
| Journey™ Launch Set                | 17 |
| Liberty Bell 7 Mercury             | 53 |
| Redstone                           | 52 |
| Little Joe I™                      | 52 |
| LoadStar II™                       | 41 |
| LoadStar II™ Bulk Pack             | 88 |
| Lynx™                              | 47 |
| Magician™                          | 60 |
| Majestic™                          | 63 |
| Mean Machine™                      | 31 |
| Mini "A" Heli™                     | 44 |
| Mini Comanche-3™                   | 40 |
| Mini Fat Boy™                      | 29 |
| Mini Honest John                   | 54 |
| Mini Mean Machine™                 | 31 |
| Mongoose™                          | 39 |
| Mosquito™                          | 25 |
| Multi-Roc™                         | 38 |
| Nike Apache                        | 57 |
| Nike Smoke                         | 57 |
| Nike-X™                            | 35 |
| No. 2 Estes Sky Writer®            | 19 |
| Nova™                              | 21 |
| Odyssey™                           | 49 |
| Phantom Blue™                      | 21 |
| Phantom™                           | 92 |
| Power Patrol™                      | 24 |
| Protostar™                         | 46 |
| Puma™                              | 48 |
| QuinStar™                          | 45 |
| Rascal™ & HiLinks™ Launch Set      | 16 |
| Red Nova™                          | 35 |
| Riptide™ Launch Set                | 17 |
| Rocket Science Starter Set         | 95 |
| Rookie™                            | 22 |
| SA-2061 Sasha™                     | 60 |
| Saturn V 1:100 Scale               | 58 |
| Saturn V 1:200 Scale               | 59 |
| Savage™                            | 40 |
| Sequoia™                           | 29 |
| Show Stopper™                      | 22 |
| Shuttle Xpress™                    | 44 |
| Sky Warrior™                       | 30 |
| Solaris™                           | 23 |
| Space Crater™                      | 32 |
| Space Twister™                     | 28 |
| Spirit™                            | 20 |
| Star Orbiter™                      | 63 |
| Starship Nova™                     | 46 |
| Star Trooper™                      | 25 |
| Sterling Silver™                   | 39 |
| Sundancer™                         | 18 |
| Super Big Bertha™                  | 33 |
| Super Neon™                        | 29 |
| Super Nova™                        | 41 |
| Swift™                             | 26 |
| Tandem-X™ Launch Set               | 13 |
| Taser™ Launch Set                  | 12 |
| Twin Factor™                       | 39 |
| U.S. Army Patriot M-104            | 55 |
| UP Aerospace™ SpaceLoft™ Bulk Pack | 86 |
| V2                                 | 55 |
| Viking™                            | 27 |
| Viking™ Bulk Pack                  | 87 |
| Wacky Wiggler™ Launch Set          | 16 |
| Whirlybird™ Launch Set             | 14 |
| Wizard™                            | 26 |
| Wizard™ Bulk Pack                  | 87 |
| Yankee™                            | 26 |
| Zinger™                            | 19 |
| Zombie™ Launch Set                 | 14 |

### General

|                          |       |
|--------------------------|-------|
| Accessories              | 70-81 |
| Altimeter                | 77    |
| Altitrak                 | 76    |
| Bulk Packs for Educators | 84-89 |
| Designer's Special™      | 81    |
| Engine Performance Chart | 66-67 |
| Engine Thrust Curves     | 69    |
| Estes Education          | 82-83 |
| Fun Recovery             | 42    |
| How Engines Work         | 6     |
| Introduction             | 2-3   |
| Launch Sets              | 10-17 |
| Model Rocketry Basics    | 5     |
| Model Rocket Engines     | 68    |
| Multi-Stage Rockets      | 36    |
| NAR Safety Code          | 96    |
| Parachutes               | 80    |
| PS II™                   | 62    |
| PS II™ Accessories       | 64    |
| Rocket Kit Details       | 9     |
| Scale Models             | 50-59 |
| STEM Learning            | 83    |
| Supporting Organizations | 99    |
| Warranty                 | 97    |
| Welcome                  | 4     |
| Where to Launch          | 8     |

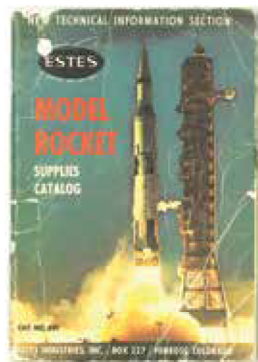

Estes catalogs are highly collectible! We recommend keeping it but if you choose not to, please recycle.



# Get Involved!

Below you'll find links to the web pages of respected groups and institutions who support our contributions to the development of young people. Like Estes, many of these organizations provide their own unique learning opportunities for students, youth leaders and teaching professionals. Together, we strive to create an environment rich with resources to keep your students interested, inquisitive, and inspired. Please take a moment to visit their sites today.



[nar.org](http://nar.org)



Girl Scouts  
Where Girls Grow Strong

[girlscouts.org](http://girlscouts.org)



[challenger.org](http://challenger.org)



[rocketcontest.org](http://rocketcontest.org)



[ymca.net](http://ymca.net)



[4-h.org](http://4-h.org)



[spacecamp.com](http://spacecamp.com)



[scouting.org](http://scouting.org)



[gocivilairpatrol.com](http://gocivilairpatrol.com)



BOYS & GIRLS CLUBS  
OF AMERICA

[bgca.org](http://bgca.org)



Prices and availability are subject to change without notice. Color of product may vary.

© 2019 Estes Industries, LLC, 1295 H Street, Penrose, CO 81240-9698.  
All rights reserved. Printed in USA. PN2927-19 (3-19)



**New  
for 2019!**

**2927**



**estesrockets.com**