

# MULTI-STAGING PRINCIPLES



## INTRODUCTION

Multi-staging is an excellent way to attain high altitudes with a model. An understanding of basic staging principles is needed to fly any 2 or 3 stage "bird" successfully. The following information can be useful in building, prepping and flying Centuri multi-stage models, or "own-designs" constructed from Centuri custom parts. Staged models require extra care in assembly and handling as they are about twice as challenging as standard model rockets.

Staging is a concept where one engine's velocity is added to an already existing velocity of another engine. To illustrate, we will use a typical 2-stage design based on a #7 body tube diameter. A variety of terms are used to name the main parts of a multi-stage rocket.



1st Stage  
Lower Stage  
Booster

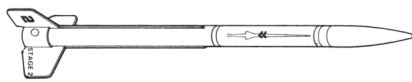

2nd Stage  
Upper Stage  
Sustainer

## HOW PASS-PORT STAGING\* WORKS:

The booster (or 1st stage engine) is ignited by a standard electrical model rocket launch system.

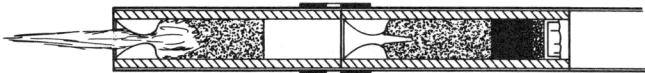

This engine contains propellant, but no delay or ejection material, and is designated with a code ending in zero (example: A8-0). As the intense flame burns forward, it breaks through the top of the propellant grain. Hot particles of still-burning propellant shoot forward into the nozzle of the second stage engine, igniting its propellant. (Ordinary flame, such as from a match, will not ignite model rocket engines.)



In the Centuri Pass-Port Staging System\*, some of the rapidly expanding gases are allowed to escape through the 2 ports in the coupler joining the stages. This allows just enough time (a split second) to ignite the next stage before the first stage blows away completely.

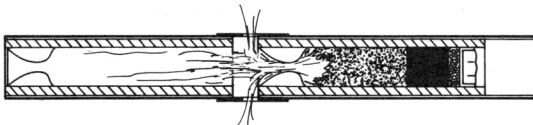

The first stage alone is an aerodynamically unstable body that will tumble or glide safely to Earth. Meanwhile, the second stage climbs, the thrust of the second stage being added to the already existing velocity created by the first stage. The upper stage contains a recovery system and an engine with the standard configuration of propellant, delay and ejection material.

## DESIGN & CONSTRUCTION

The number of stages possible is limited only by the available boost power of the first stage engine (the first stage engine must be able to lift the weight of all the stages and their engines). Four stages is probably the maximum and this would require extreme care in design and construction. For instance, each section's fins must be larger than those above it, and must be glued on extra securely.

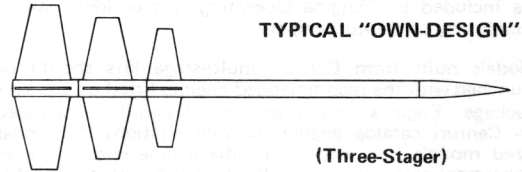

TYPICAL "OWN-DESIGN"

(Three-Stager)

The uppermost stage of a well designed multi-stage bird usually may also be flown by itself as a single-stage rocket. For best results, booster stages may be kept to no more than 3" in length. Large fins are required for adequate stability and to slow the "tumble" speed during recovery. Staging coupling is important and Centuri's Pass-Port Staging System\* is a must for effective auto-ignition. Best all around results are obtained from rockets using a #10 series body tube. One feature of multi-staging rockets (especially 3 stages) is the tendency to "weathercock". Because of the large amount of fin area, the rocket tends to be over-stable. When flown in a breeze, this over-stable condition causes the rocket to turn into the wind. The harder the wind, the more the tendency to "weathercock". For this reason it is advisable to fly multi-stages only in calm weather.

## TYPICAL THREE STAGE CONSTRUCTION EMPLOYING CENTURI'S "PASS-PORT" STAGING SYSTEM\*

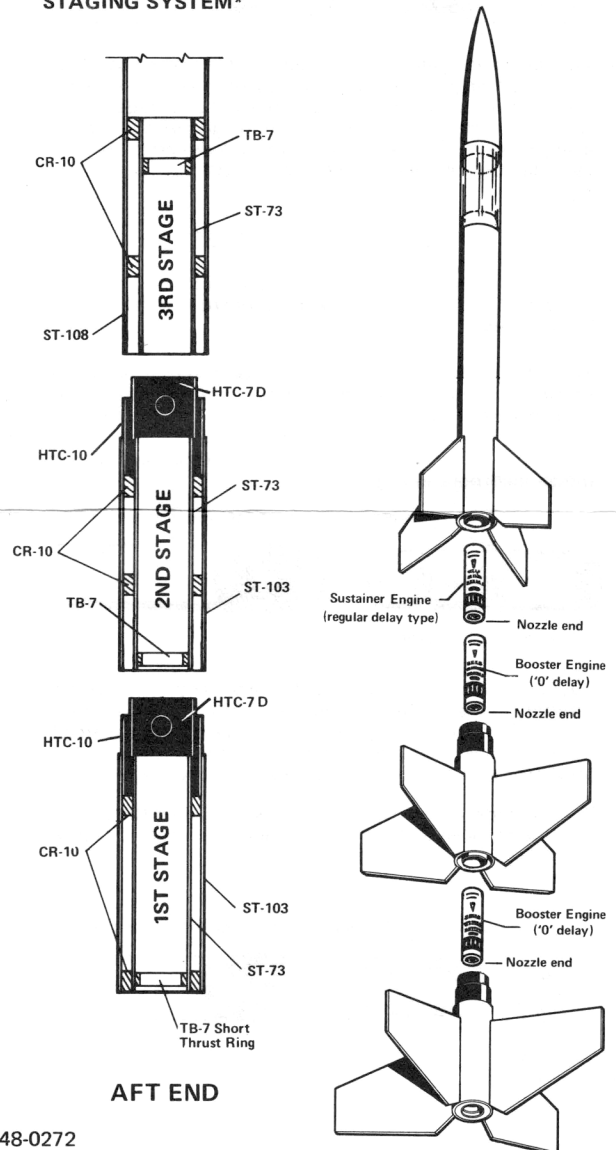

## PREPPING AND LAUNCHING

Altitudes achieved will depend on engines chosen and on model workmanship. Remember that extremely high flights are usually unable to be "tracked" by inexperienced observers. Do not launch on overcast days as the model may be lost to sight forever.

### ENGINES

Igniters and complete engine installation instructions are included in "Engine Operating Instructions" which accompany all Centuri engines.

Models built from Centuri multi-stage kits should be launched with the recommended engines listed on the kit's package. Engines chosen for "own designs" can be based on Centuri catalog engine recommendations for similar sized models. In any event, the engine chosen for an uppermost stage would usually have the longest available delay time in its' class. (Example: 1/2A6-4, A5-4, B4-6, B6-6, B14-7, or C6-7.)

B-14 engines, with their high initial thrust, are generally used to "lift-off" the larger and heavier staged "birds".

The typical #7 two-stager discussed in the introduction could be flown with any of the following engine combinations.

Booster (1st stage)	Upper Stage (2nd stage)	Optimum Altitude in Feet	Purpose
A8-0	A5-4	800	Use this combination for first test flights and medium sized launch areas.
B6-0	B4-6	1200	Medium to High Altitude — for general flying and moderately large launch areas.
B6-0	C6-7	1800	
C6-0	B4-6	2000	Extremely High Altitudes — and very large launch areas.
C6-0	C6-7	2400	

This chart is only a rough guide. You may note that while "C" engines are twice as powerful as "B" engines, the "C"s do not necessarily give twice the altitude. Likewise, a two-stage rocket will not quite go twice as high as a single stage. This is because some aerodynamic efficiency is lost through drag at higher air speeds.

### MOUNTING ENGINES

Engines must be held firmly in place to withstand forward movement while thrusting, and rearward motion during burn-through.

Test-fit the recommended upper stage engine into the upper stage vehicle to see how far up it must go. Remove, wrap engine with masking tape and insert again. Enough tape must be used to insure a firm, tight fit. When properly taped, leave engine in place. No tape necessary if model incorporates engine lock.

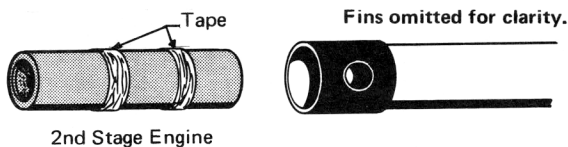

Couple the upper stage and booster sections together carefully. Insert the recommended booster engine into place. Many multi-stage kits are designed with a small thrust bulkhead at the rear of the lowest stage. This prevents rearward engine movement at booster ejection.

If your model does not have the bulkhead, then the engine must be wrapped with tape, as in the upper stage, to secure it in place.

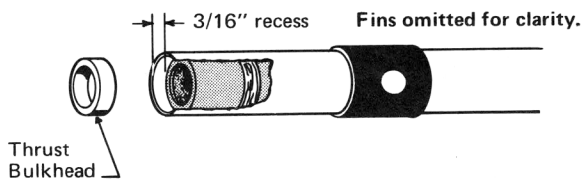

## RECOVERY SYSTEMS

Staged model rockets are capable of reaching altitudes over 2000 feet. At extreme altitudes the wind speed is often greater than at surface level. A staged rocket equipped with a standard parachute may be caught in a breeze, and drift as much as several miles before returning to earth.

Here are several ways to avoid drift:

1. Never launch in winds over 15 or 20 mph.
2. Tilt launcher slightly into wind to compensate for distance. Returning rocket will then drift back closer to launch area.
3. Some stage rockets are intentionally supplied with a streamer rather than a parachute. The drogue recovery streamer will allow the rocket to descend nearer to the launch site.

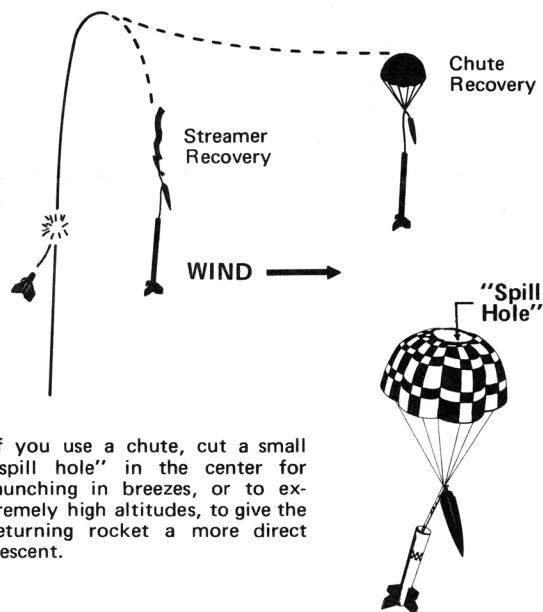

If you use a chute, cut a small "spill hole" in the center for launching in breezes, or to extremely high altitudes, to give the returning rocket a more direct descent.

### FLIGHT PREPARATION

1. Tape and insert recommended engines.
  2. Be sure booster type engine is in 1st stage, and standard type engine in the uppermost stage.
  3. Be sure all engines have their nozzles pointing rearward.
  4. Never use a standard engine in a booster because this will almost certainly cause a crash.
  5. Clean any exhaust residue from coupler area to insure a good fit.
- NOTE:** When fully prepared, stages must couple together smoothly and snugly. Fit should be tight enough so that boosters do not fall out of upper stage by their own weight.
6. Inspect shock cord and fastener for firm bond.
  7. Insert Flameproof Parachute Wadding according to its directions.
  8. Tuck in shock cord.
  9. Neatly roll streamer tightly and insert.
  10. Socket nose cone in place (apply a piece of thin tape on the nose cone base, if necessary, for a snug fit).
  11. Fly over soft dirt or grassy areas to minimize damage to the tumbling booster.

### PASS-PORT STAGING\*

\*Patent pending. Any individual who wishes to construct a Pass-Port Staging assembly incorporating the invention covered by this pending application and any patent which issues thereon on a non-profit, non-commercial basis is hereby granted a royalty-free, non-exclusive license to practice this invention. Such license is not granted to persons or firms which practice this invention or induce the practice of this invention for profit or on a commercial basis.