



# SUNWARD DESERTFOX Model Flying Rocket

Recommended for Ages 16 and up.  
 Adult supervision required for ages 14-15 with  
 Intermediate skill level recommended  
 Plastic bags should always be kept away from babies and  
 children to avoid suffocation.

**For support:**  
[www.sunward1.com](http://www.sunward1.com)  
[Info@sunward1.com](mailto:Info@sunward1.com)

Use only single stage engines in this model  
 Recommended engines: B6-2 (First Flight), B6-4, C5-3, C6-3, C6-5  
 D12-3, D12-5  
 Launch Pad, Ignition System, Engines, Igniters  
 and Recovery wadding not included

1 MAIN BODY TUBE 18" (45cm) LONG



2 ENGINE CENTERING RINGS



1 ENGINE THRUST RING



1 ENGINE TUBE

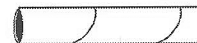

NOSE CONE

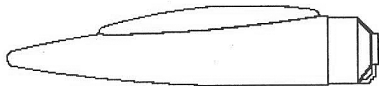

1 METAL ENGINE HOOK



CAREFULLY USE A HOBBY KNIFE TO CUT OFF EXCESS PLASTIC  
 DO NOT CUT OFF EYELET RING.

1 PARACHUTE SHEET

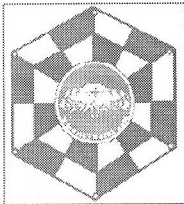

1 PARACHUTE ASSEMBLY STRING



1 LAUNCH LUG



1 ELASTIC SHOCK CORD



1 DECAL SHEET



"JET ENGINE INTAKE" WRAP-AROUND  
 AND FIN REINFORCEMENT SHEET

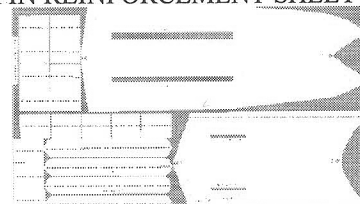

2 LASER CUT BALSA WOOD FIN SHEETS

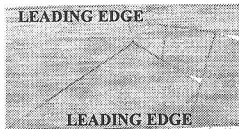
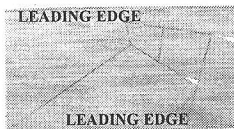

6 PARACHUTE REINFORCEMENT RINGS



NOTE: Balsa wings and fins must be removed only by cutting  
 them out with a hobby knife. If you try to "punch" them out by  
 hand, they may be seriously damaged

You will also need:

A ruler, 3/4" (2cm) thick book, white glue, scissors, hobby knife, cellophane tape, pencil, fine sandpaper, spray paint.

To install and ignite rocket engine, follow the instructions that are included with the engines or launch pad

This model is built to work with igniters, engines, recovery wadding and launch pads built by the leading manufacturers

## "D" Motor Assembly Instructions

Use these set of instruction to use "D" engines instead of B/C engines.

1 ENGINE THRUST RING

2 ENGINE CENTERING RINGS



1 ENGINE TUBE

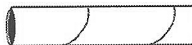

## "D" Assembly Instructions

A) On the engine tube, mark two lines at  
 1/4" / 6mm and at 1 3/4" 44mm

B) Cut 1/4" 6mm slit

C) Place glue as shown. Position hook.  
 Hook may not be exactly as shown.

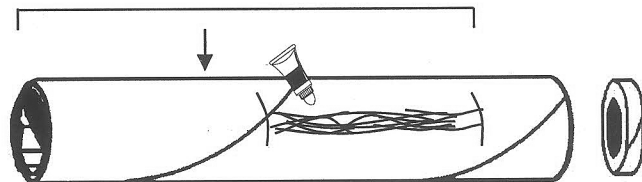
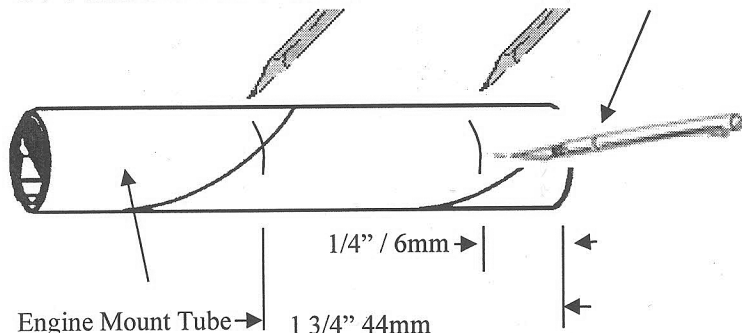

D) Glue smallest ring (thrust ring) inside engine  
 tube, making it even with the end of the engine tube



E) Slide one engine centering ring (#1) to pencil mark shown from end "a"

F) Slide second engine centering ring flush with end of engine tube

G) Complete tube should be as shown. Install in place of B/C engine mount where shown in instructions. Use D12-3 or D12-5 engines.

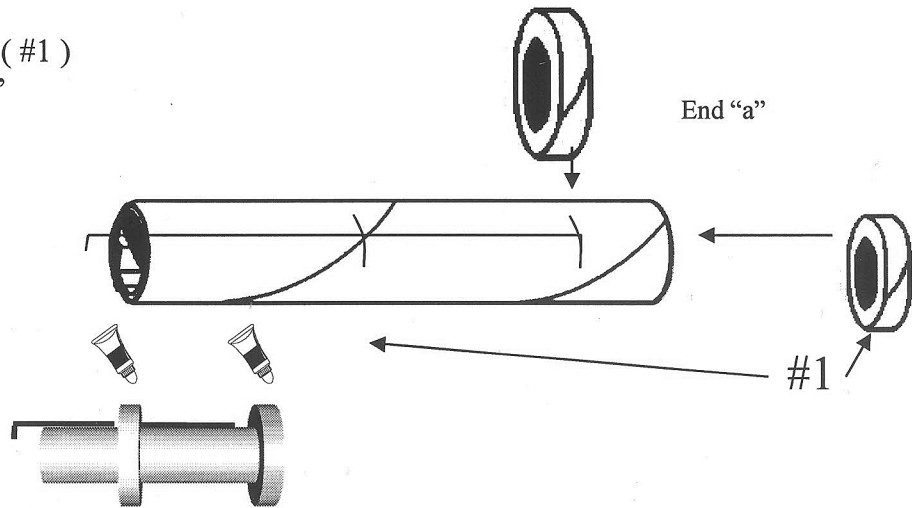

## B/C Motor Assembly Instructions

A) On the engine tube, mark two lines at  $3/16''$  / 5mm and at  $1\ 3/4''$  44mm

B) Cut  $3/16''$  5mm slit

C) Place glue as shown. Position hook. Hook may not be exactly as shown.

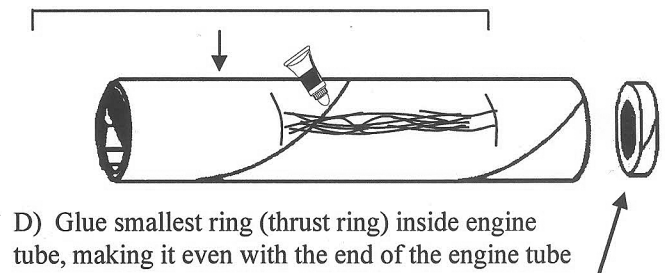
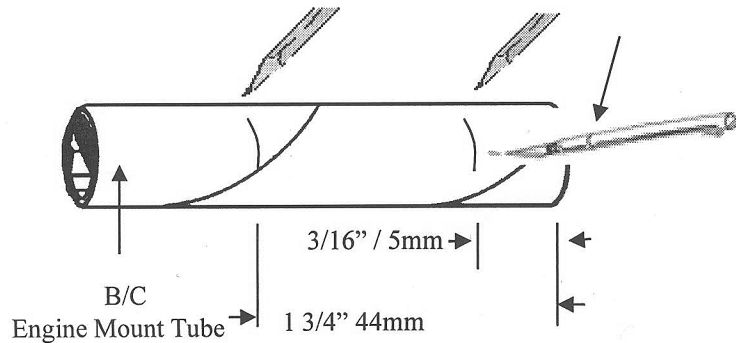

D) Glue smallest ring (thrust ring) inside engine tube, making it even with the end of the engine tube

E) Slide one engine centering ring (#1) to pencil mark shown from end "a"

F) Slide second engine centering ring flush with end of engine tube

G) Complete tube should be as shown.

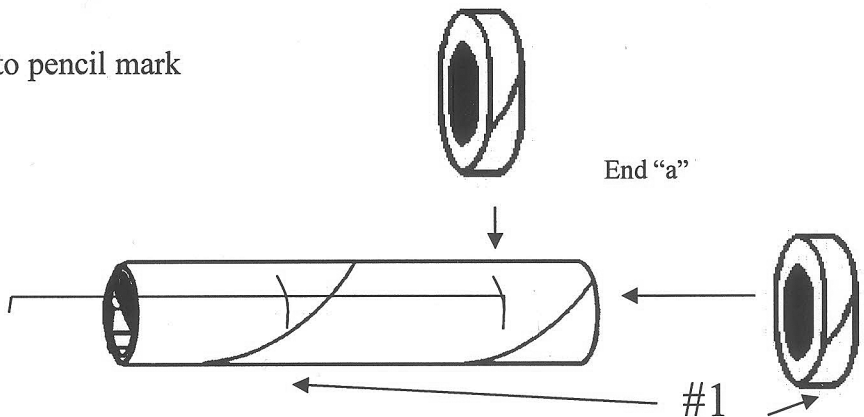
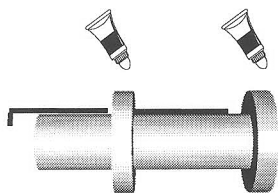

#2: CUT OUT THIS MARKING TEMPLATE ALONG THE OUTSIDE EDGE

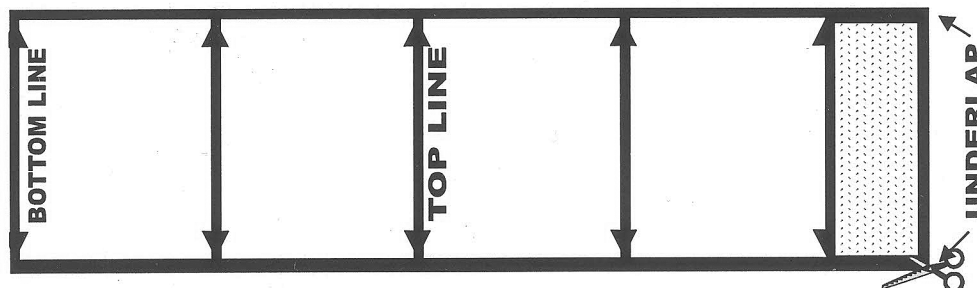

**# 3:** Wrap template around body (larger) tube. Fasten it together with tape so that the shaded area is over lapped by the "bottom line" marking. Tape template in place around the middle of the body tube. Mark body tube where arrows point, then remove template.

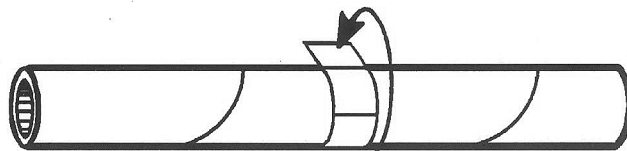

**# 4:** Using a hard cover book as a straight edge, draw lines from one end of body tube to the other end. Be sure that they match up with the marks you just made on the body tube. Be careful to make them as straight as possible!

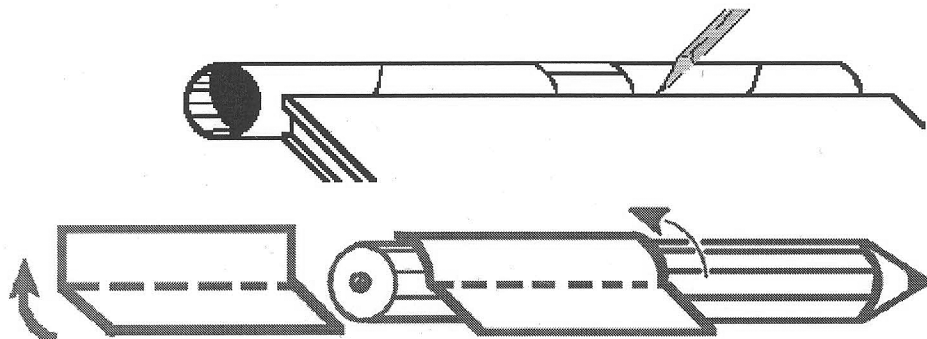

**# 5:** Cut out shorter reinforcement tabs.  
 A) fold each on dotted line so that shiny side is on the inside.  
 B) using a pencil or other round object, curl one side of each tab backward as shown in diagram.

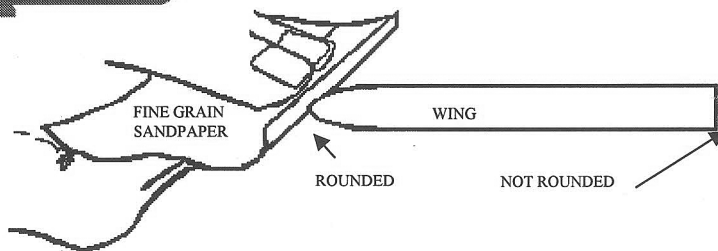

**# 6:** Carefully cut out all the wings from balsa sheet with a hobby knife. Do not attempt to "punch" them out by hand as this will severely damage the wings. Sand wings, round edges

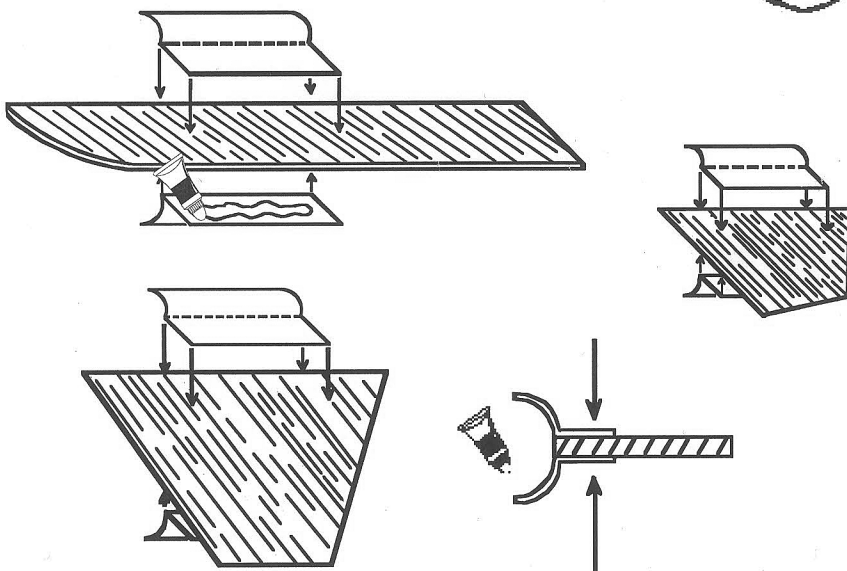

**# 7:** Glue the reinforcement tabs to each wing as shown in diagram.

A) make sure you glue the flat side of the tab to the wing as shown. Note the wood grain direction!  
 B) make sure you position the tabs on the correct edge of each wing as shown.  
 C) glue tabs near the middle of the correct edge of the wing. Make sure the tab is flush with the edge of the wing.  
 D) glue tabs on the bottom of each wing in the same location as the tab on the top of the wing. Do not attach tabs to either the very small fins or to the top tail fins yet.

**# 8:** Turn each rear wing over so that its curled tabs face up as in diagram. Spread a moderate amount of glue all over the inside surface of the tabs. Run a bead of glue along the wing edge itself next to the tabs

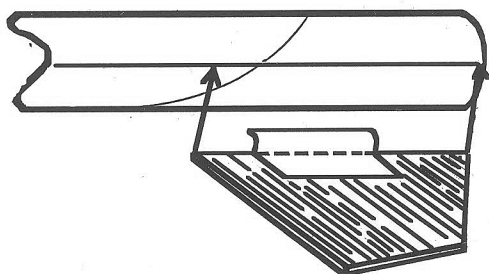
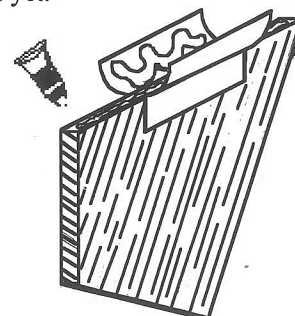

**# 9:** Glue the rear wings on the side of the body tube as shown in the diagram.

A) wings should be flush with the very end of the body tube and should line up with one of the side lines you drew on the body tube with the template earlier.  
 B) note the direction of the wing and the direction of the wood grain.  
 C) press tabs down until glue sets.

**#10:** Glue the main wing on the body tube the same way you glued on the rear wing. The main wing's rear edge should touch the rear wing.

A) make sure the main wing lines up with the line on the body tube.

B) again, make sure the wood grain of the wing goes the same direction as the wing in the diagram.

C) press down tabs until glue sets.

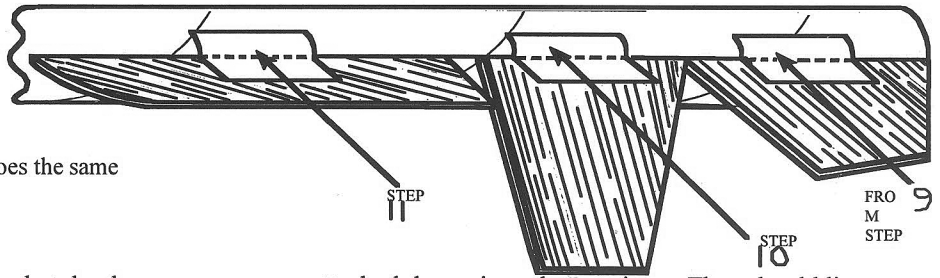

**#11:** Attach the front stabilizer wings to the body tube the same way you attached the main and rear wings. They should line up with the same side line, and their rear outside corner should just touch the main wing's front edge. Press down on tabs until glue sets. The rear, main, and front stabilizer wings on the other side will be attached the same way on the side line on the other side of the tube. The rear wing will be flush with the end of the tube and each and the remaining wings will touch the front edge of the wings behind them.

Be careful to ensure that the wood grain always points out and toward the back end of the plane as shown in the diagrams.

“PLANE SHOULD NOW LOOK LIKE THIS”

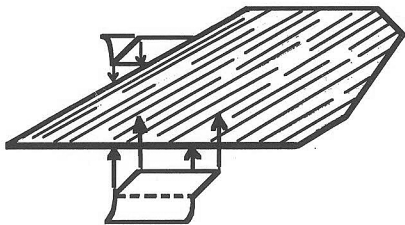

**#12:** Cut out remaining small reinforcement tabs.

A) Fold and curl one side of these tabs as you did for the other set.

B) Glue them onto the rear fins the same way as with the wing tabs.

**#13:** Measure and mark the body tube on top of the rear wings 1 1/4" (3cm) from the rear of the plane.

A) Glue the rear fins into place so that they sit in the groove where the wings and body tube meet.

B) The rear edge of the rear fins should line up with the 1 1/4" (3cm) mark you made.

C) Do the same for both sides and make sure the wing and wood grain matches the diagram.

D) Press the tabs to the wings and body tube until glue sets.

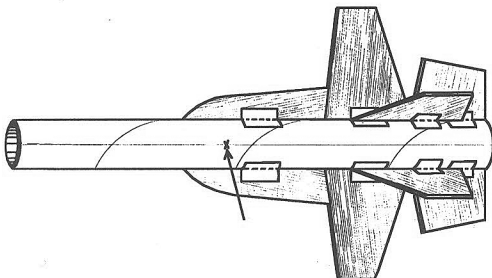
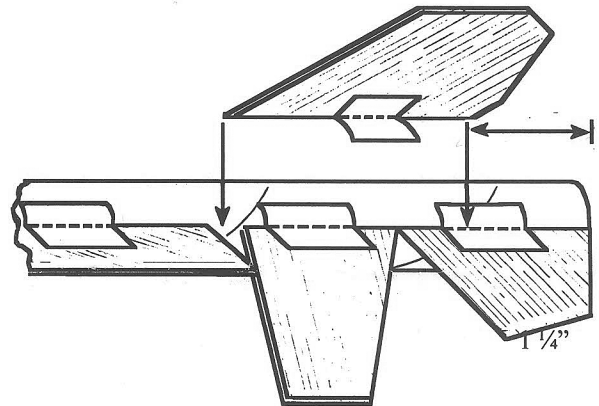

**#14:** Your plane should now look like this: measure and place a mark on the top line you drew with the template. The mark should be placed 10 1/2" (26.5cm) from the rear of the plane.

**#15:** Cut out the top body wrap from the reinforcement tab sheet. Use a hobby knife to cut out the slots for the top fins.

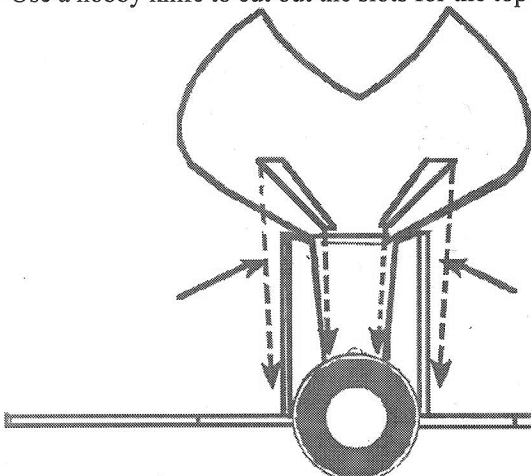
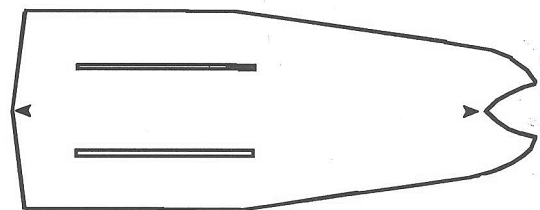

**#16:** Test fit the top body wrap by sliding it over the rear fins and into place on the plane. The "front" arrow between the two points should touch the mark you just drew. If it does not, draw a new mark.

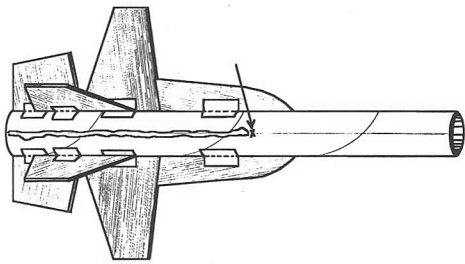

**#17:** Run a bead of glue along the "top line" mark you made to the rear of the plane.

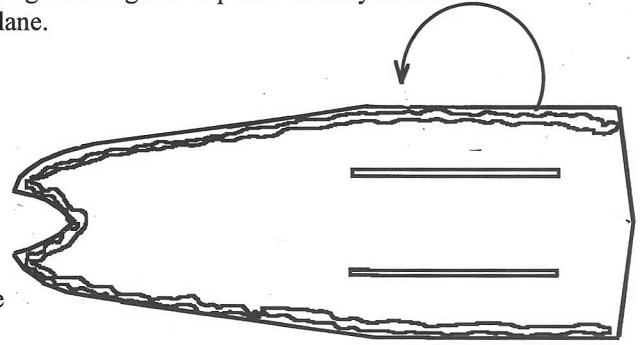

**#18:** Run a bead of glue around the outside of the top body wrap as shown.

Note - glue the side which does not have arrows printed on it, (that is, the non-shiny side.)

Do not get glue on the shiny side of the body wrap.

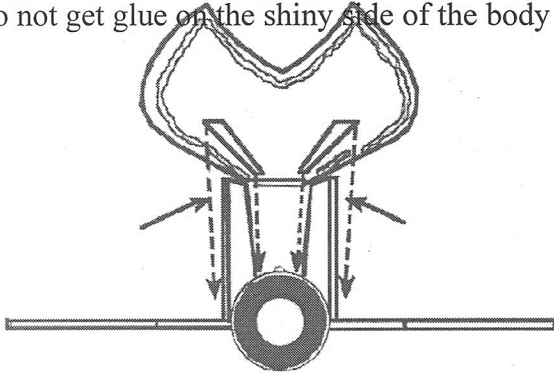

**#19:** Slide the body wrap onto the plane by squeezing the rear fins together until they will slip through the slots in the body wrap.

A) make sure the two arrows on the body wrap line up with the top line on the body tube.

B) make sure it fits properly along the base of the top fins.

**#20:** A) Press all glued edges down so that body wrap curls around top contours of plane evenly and attractively.

B) Body wrap should be 1/8" or less from the side edges of the front stabilizer wings at the middle of those wings.

C) Carefully press down the two points at the front of the body wrap so that they fit and bond into the grooves between the body tube and the front stabilizer fins

D) Hold them in place until they bond. Press down all glued edges until they bond.

*Be careful to ensure the wings remain flat on both sides of the plane.*

The plane should now look like the one in the diagram. Let all the glue dry before proceeding further.

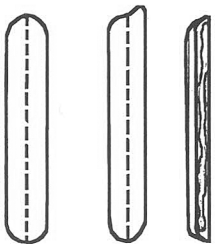
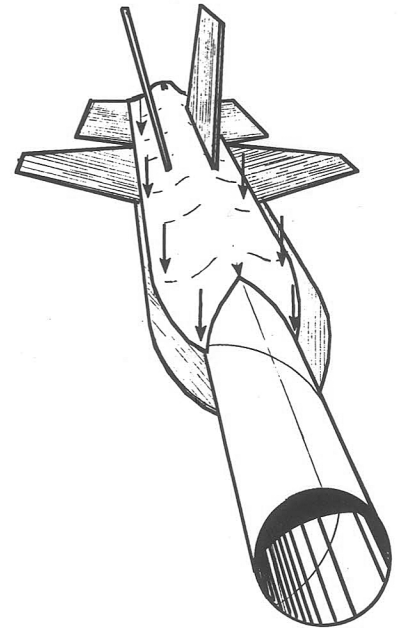

**#21:** Cut out and fold, but do not curl, the long top fin gap covers. Make sure you fold the tabs so that the shiny side is inside the fold.

A) run a bead of glue on both outside edges.

B) Glue these gap covers into the groove between the rear fins and the top body wrap.

Do this for both fins on each side of each fin

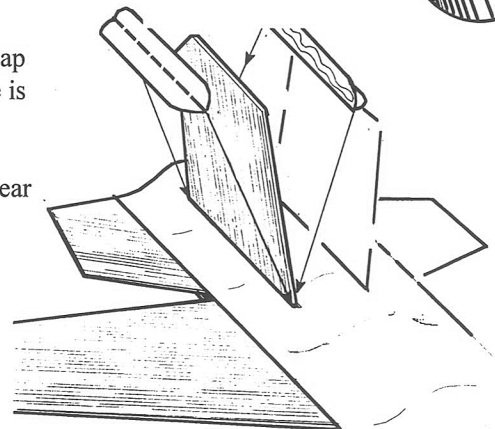

**#22:** Squeeze several thick beads of glue around the inside of the body tube at the rear of the plane. Use a good amount of glue and smear it around inside the rear of the body tube as far as your finger will reach.

**! Choice:**

Install either B/C or D Engine Mount

**! Install D engine mount so end of engine tube is even with edge of body tube**

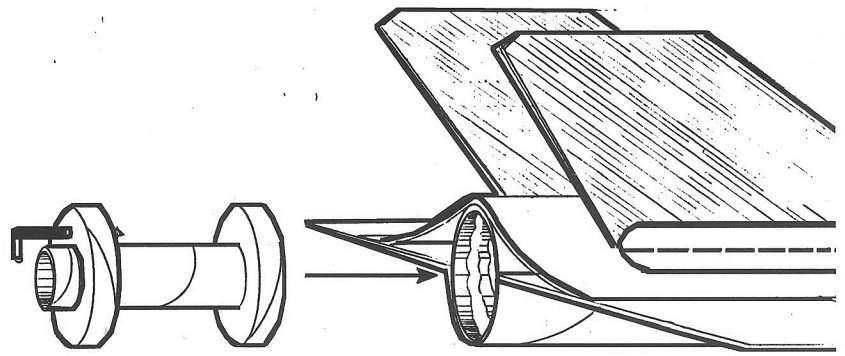
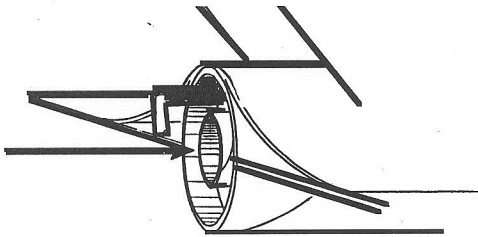

**# 23:** Slide the engine mount into the rear of the plane so that the hook sticks out and the engine tube is flush with the body tube.

**# 24:** A) With a ruler, draw a mark on the bottom line, 7" (17.2 cm) from the rear end of the plane.

B) measure and draw marks on the front edges of the rear and main wings 3/4" (17mm) out from the body tube.

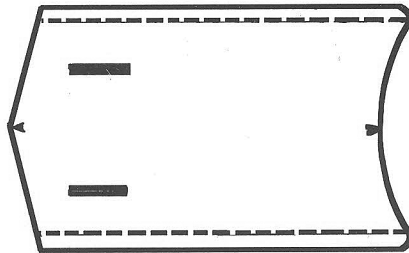
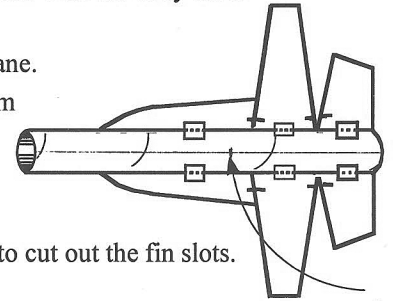

**# 25:** Cut out the bottom body wrap. Use a knife to cut out the fin slots.

**# 26:** Fold the side tabs back along the dotted lines of the bottom body wrap so that the shiny surface is on the outside of the fold. Curl bottom body wrap as shown.

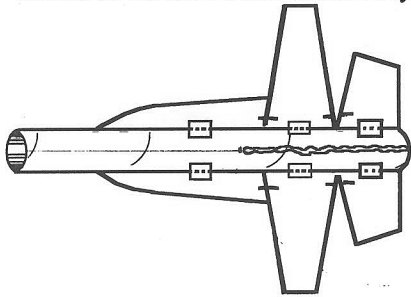
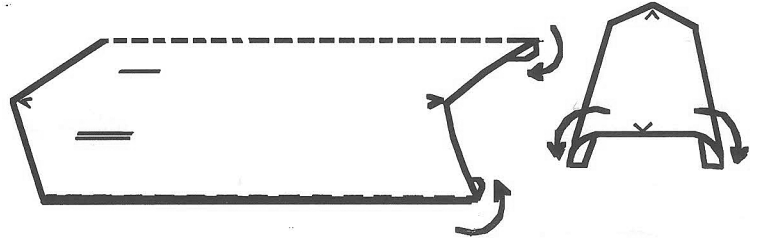

**# 27:** Run a bead of glue along the bottom line of the plane to the 7" (17.2 cm) line you drew in step 25 (A).

**# 28:** Run a bead of glue along the shiny side of folded tabs on the bottom body wrap

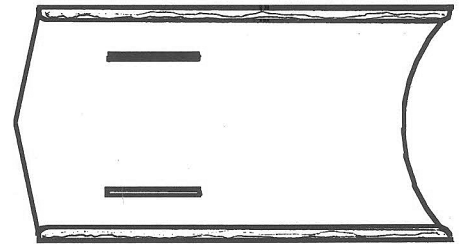

**# 29:** Glue the bottom body wrap to the plane so that its arrows line up with the bottom line on the plane and the front arrow on the bottom body wrap meets the 7" (17.2 cm) mark you drew in step 25.

A) attach the folded under tabs of the bottom body wrap to the main and rear wings so that the fold lines up with the 3/4" (17 mm) marks you drew on the wings.

B) hold in position until glue sets.

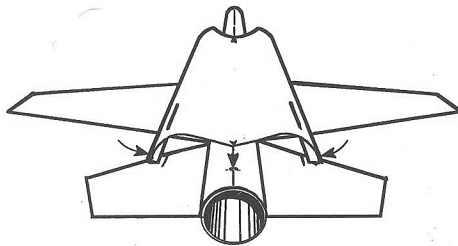

**# 30:** A) run a bead of glue along the bottom edge of the bottom fin as shown in diagram.

B) slip fin, glue side first, through the slot in the bottom body wrap.

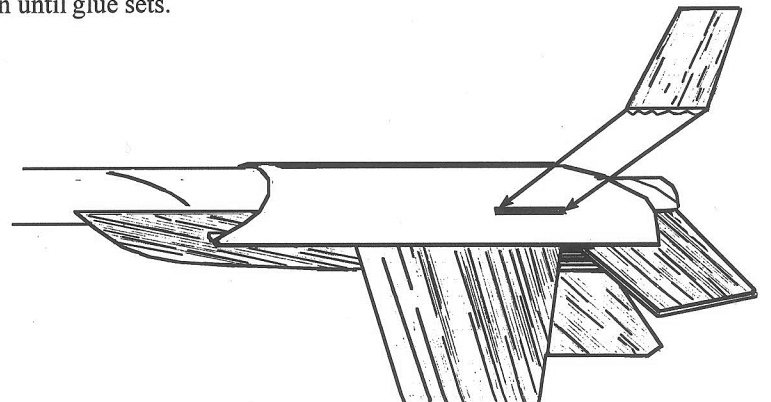

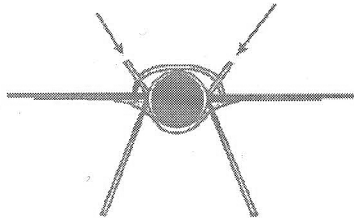

C) nestle the fin into the groove formed by the body tube and wings hold it there until the glue bonds.

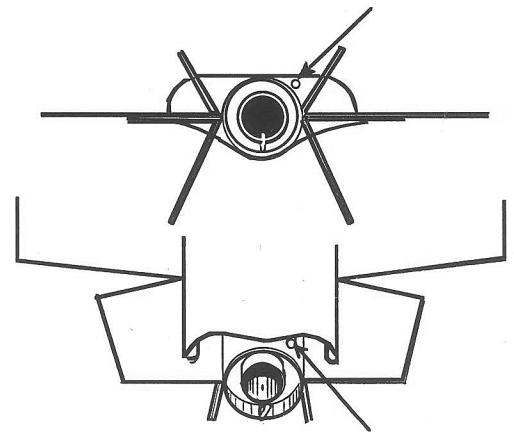

# 31: Glue the launch lug to the body tube inside the bottom body wrap area so that launch lug fits, and is glued in place in the groove formed by the bottom body wrap and body tube.

# 32: Cut Out the Following Shock Cord Mount:

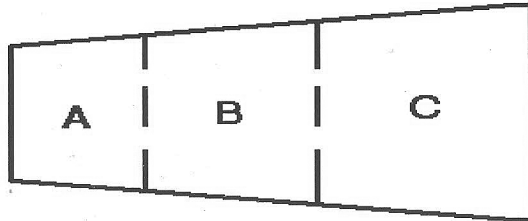

A) Put a blob of glue on the section marked "a" lay the end of the "shock cord" in the glue

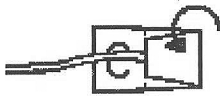

B) While the glue is still wet fold section "A" over on the dotted line and press it together with section "B"

C) Fold over sections "A" & "B" and glue them over to section "C" and press it together.

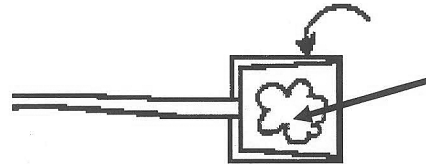

D) Put a blob of glue here

# 33: A) Glue the "shock cord mount about 1 1/2" (4.5cm) down inside the top of the body tube

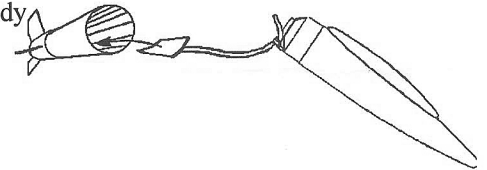

B) Tie the other end of the "shock cord" to the ring on the nose cone (ring may need to be cut open with a hobby knife so that the "shock cord" can be fed through)

### # 34: PARACHUTE

A) Cut out parachute with sharp scissors

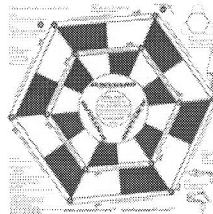

B) Cut parachute string into 3 equal lengths



C) Stick the Reinforcement Rings to the Parachute Over the Circles Printed on the Parachute

D) With a pencil, punch a hole through the circles printed on the parachute

E) Attach the strings to the parachute by tying them through the rings and holes

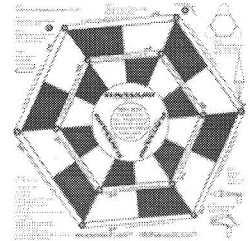

F) Pinching the parachute in the centre, bring all strings to form one loop, pass loop through eyelet on nose cone

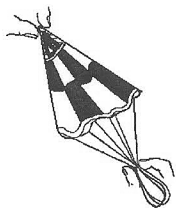

G) Pass parachute through loop and pull tight.

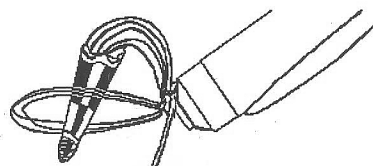

H) The parachute is now attached, fold and tuck it inside the body tube

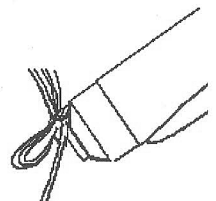



**# 35:** Painting your model:

- A. Sand wings and nose cone until they are smooth. (Rounding wing edges by careful sanding will improve appearance and aerodynamics)
- B) Sand nose cone thoroughly.

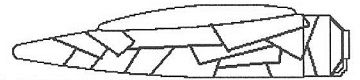

- # 36: A) Spray paint entire model with poly-ethylene – safe paint. Use light coats. Use only enough paint to cover model evenly. Keep paint can at least 14” from model
- B) Remove nose cone
- C) (Option step) when paint is completely dry, use masking tape to cover nose cone, except for canopy. Paint Black. Carefully remove masking tape after painting

**DECAL PLACEMENT SUGGESTIONS:**

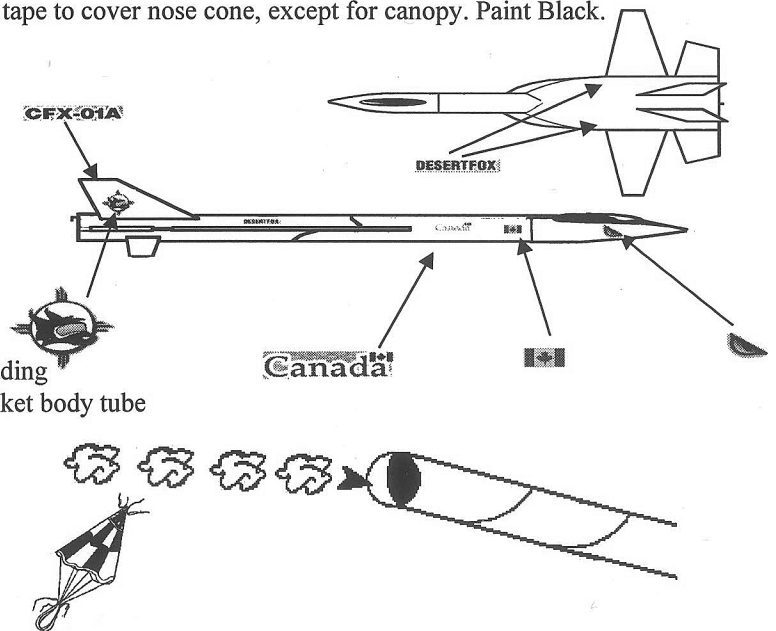

**# 37:** PREPARING ROCKET FOR LAUNCH

- A) Stuff 4 loosely crumpled squares of rocket recovery wadding (available from your local hobby retailer) into the top of rocket body tube
- B) Push down with a pencil.
- \*\*DOT USE FACIAL TISSUE – IT IS FLAMMABLE!!\*\***

**# 38:** Fold and insert parachute

- A) Pinch parachute in the centre and straighten its strings

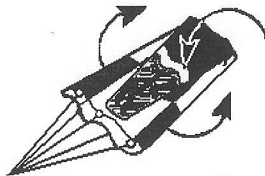

- B) Loosely fold over and roll outside edges inward

- C) Loosely wrap parachute strings around parachute and drop the parachute into the body tube

- D) Push the rest of the string and “shock cord” into the body tube and then insert nose cone.

TO INSTALL AND IGNITE ROCKET ENGINE, FOLLOW THE INSTRUCTIONS THAT ARE INCLUDED WITH THE ENGINES OR LAUNCH PAD  
 THIS MODEL IS BUILT TO WORK WITH IGNITERS, ENGINES, RECOVERY WADDING AND LAUNCH PADS BUILT BY THE LEADING AMERICAN MANUFACTURERS  
 RECOMMENDED ENGINES: B6-2 (FIRST FLIGHT), B6-4, C6-3, C6-5 D12-3, D12-5  
**\*\*USE ONLY SINGLE STAGE ENGINES!!!\*\***

**PREPARING THE ROCKET FOR LAUNCH: \*\*IMPORTANT\*\***

**FLIGHT TEST:** Every rocket must be tested for stability, here is a simple way to test stability:

- A) With engine, wadding, and parachute installed and painting done, tie a 10’ (3m) string around the rocket on its balancing point (the spot where it will hang level) tape string in place
- B) “Fly” the rocket by twirling the string over your head so that the rocket “orbits” you at high speed
- C) If the rocket flies straight, nose first, it is stable. If it does not, add weight to the nose cone. This can be done by dropping small balls of plasticine into the nose cone and pressing them into the point with the flat end of a pencil. Keep on testing, and if necessary, adding more weight to the nose cone until the rocket is stable. Then the rocket is stable, it may be launched.
- \*\*\*Never launch an untested rocket.\*\*\***

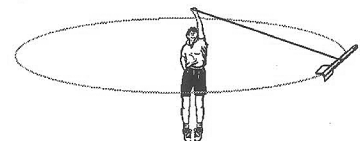
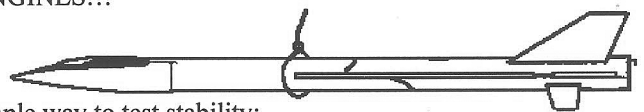

FRONT

TOP FIN SLOT

TOP FIN SLOT

FRONT

BOTTOM FIN SLOT

BOTTOM FIN SLOT

© 2000, SKYWARD MODEL AEROSPACE™  
All rights reserved. Made in Canada

BACK

TOP FIN GAP CC

TOP FIN GAP CC

TOP FIN GAP CC

TOP FIN GAP CC



BOTTOM FIN SLOT

BOTTOM FIN SLOT

BACK

TOP FIN GAP COVER

TOP FIN GAP COVER

TOP FIN GAP COVER

TOP FIN GAP COVER

TOP FIN SLOT

TOP FIN SLOT

BACK

WING AND FIN REINFORCEMENTS



1/8"

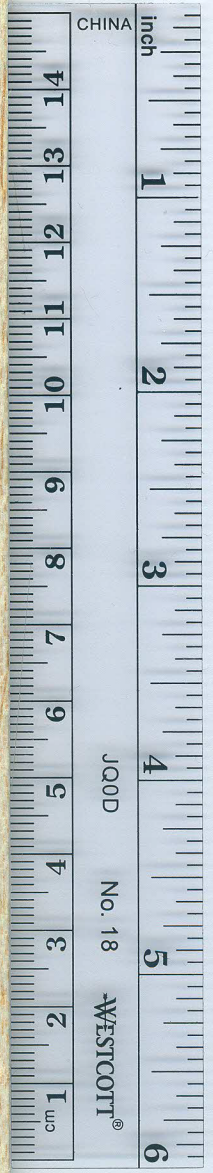



1/8"

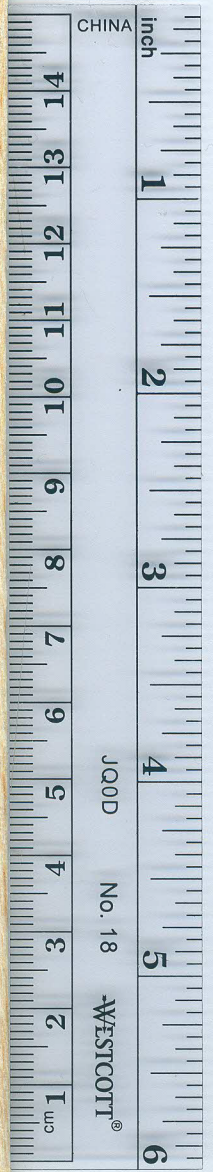
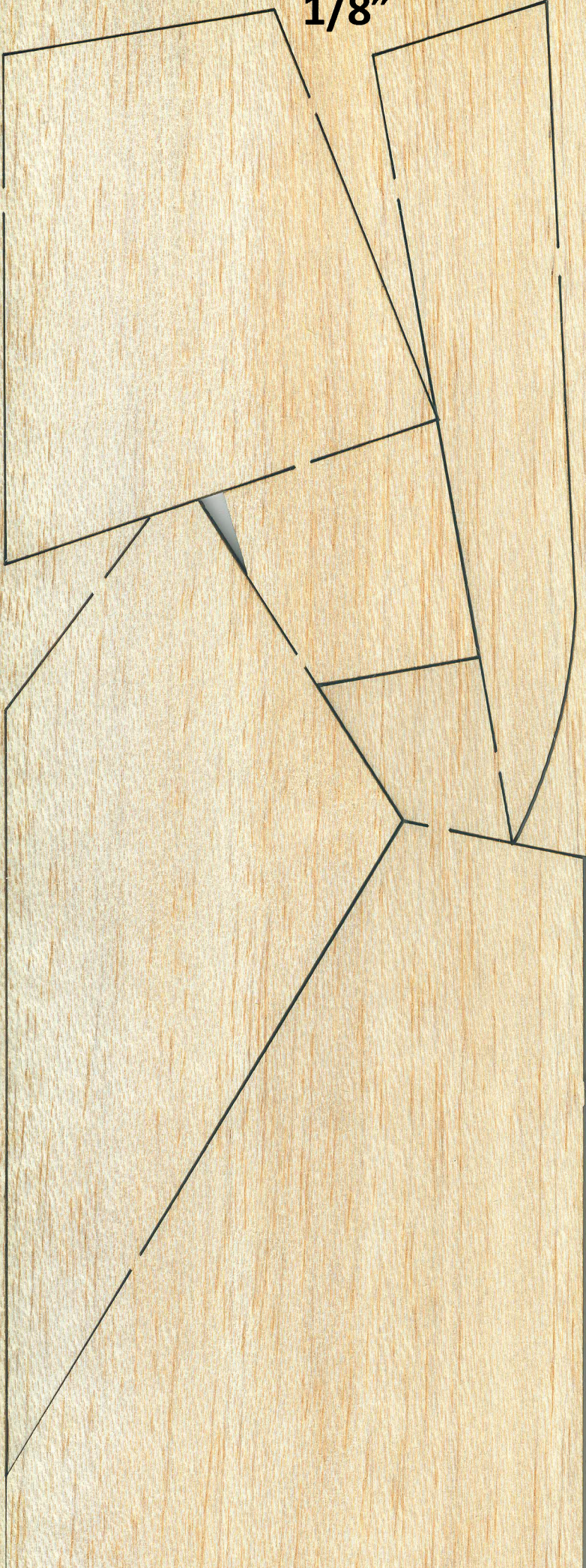



# Sunward Canopy Template

For added realism, we have provided a template for a canopy to place on the nose cones of the Jet Fighter model rocket kits.

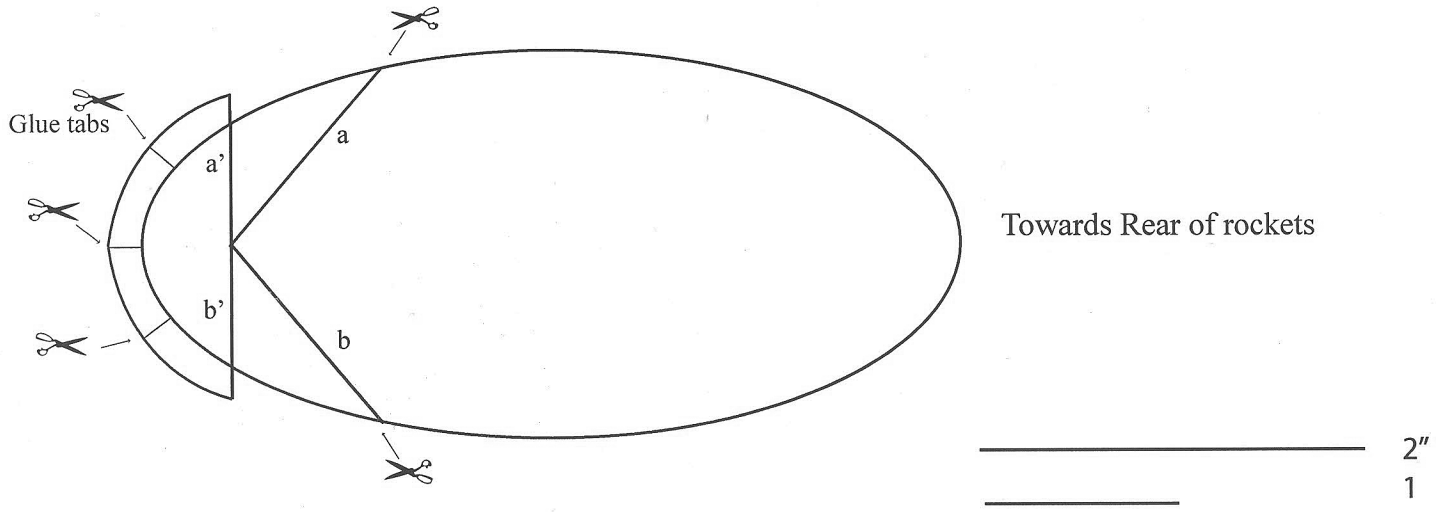

- 1) Cut on outside of template.
- 2) Cut along line "a". Fold tab under tab "a" so a' meets "a". Glue or tape in place.
- 3) Repeat for b/b'
- 4) cut 3 glue tabs
- 5) apply bead of glue along base of template and glue to nose cone. Let dry.
- 6) As shown:

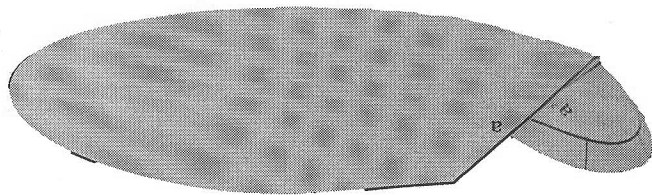

Step 1

NOT TO SCALE

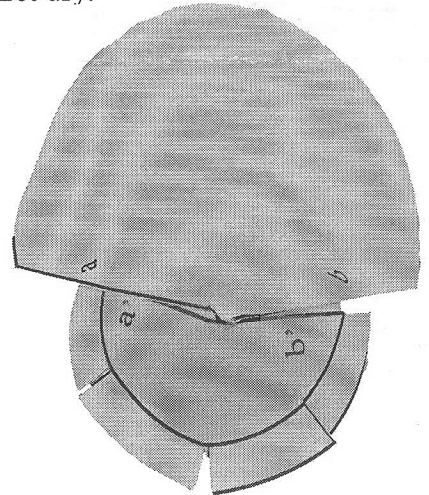

Step 2

Completed nose cone

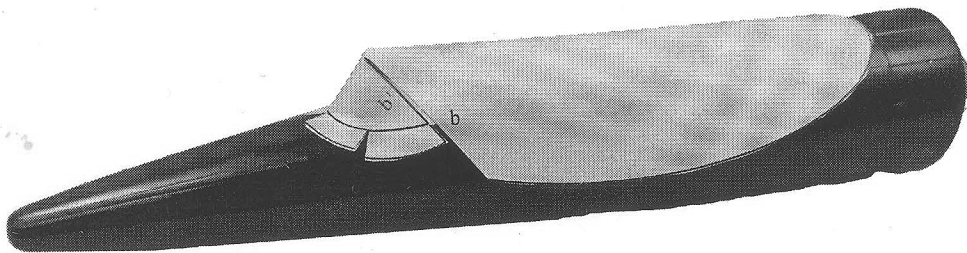



SUNWARD AEROSPACE GROUP LTD.  
SUNWARD AEROSPACE GROUP LTD.

RAF DESERTFOX DESERTFOX

CFX-01A  
CFX-01A

U.S.AIRFORCE  
U.S.AIRFORCE

RAF

© Copyright 2004

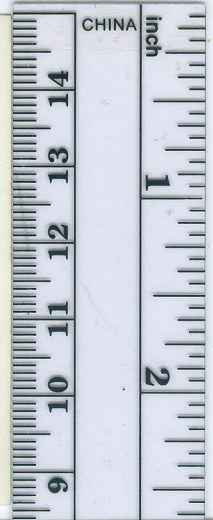



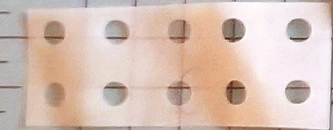

60°

45°

18" Inch

BT-56

**Care:**

18in x 12in  
(457.2mm x 300mm)

- Store flat — do not roll.
- Avoid exposure to heat and direct sunlight.
- Cut on different parts of mat to extend its life.



PARTS  
AND  
COMPONENTS

MODEL  
ROCKETS,  
ACCESSORIES

**SUNWARD**  
MODEL AEROSPACE

PARTS  
AND  
COMPONENTS

MODEL  
ROCKET  
ACCESSORIES

# THE DESERTFOX

POWER. PRECISION. PERFORMANCE.

STATE OF THE ART ROCKET/FIGHTER DESIGN

EASY TO FOLLOW INSTRUCTIONS

HIGH QUALITY LASER CUT SALSA

FLIGHTS OF SIX FEET (1.0M)

PAGE 13 PARACHUTE RECOVERY

1/2" FEASIBLE

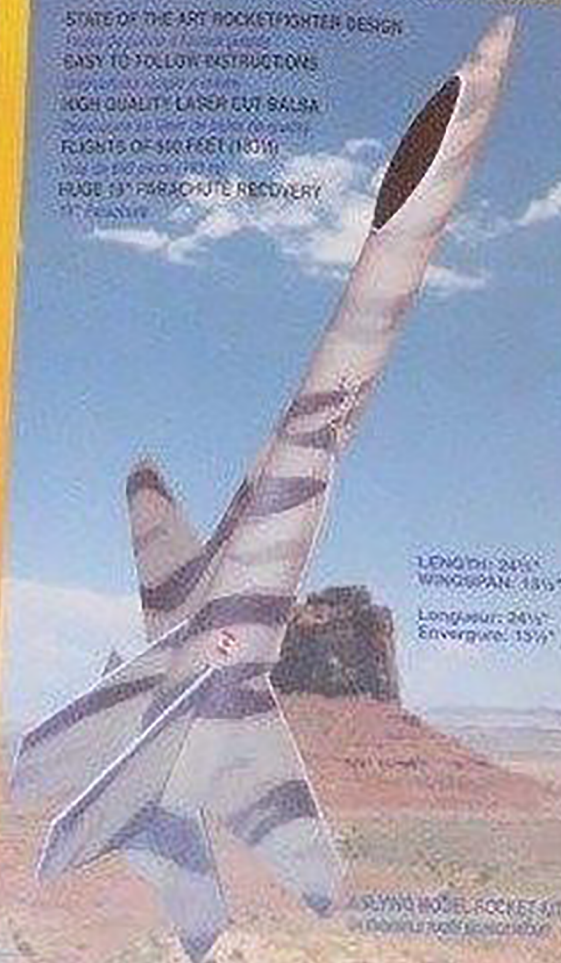

LENGTH: 24 1/2"  
WINGSPAN: 18 1/2"

Length: 24 1/2"  
Envergure: 18 1/2"

A SUNWARD MODEL ROCKET KIT  
IS AVAILABLE IN BOTH ENGLISH AND  
FRENCH

# SUNWARD

MODEL AEROSPACE

© 1997 Sunward Model Rocketry, Inc.

10000 Sunward Lane  
San Diego, CA 92121

1-800-451-7777

www.sunward.com



# The

Skill Level 3

# DESERTFOX

Model Rocket Kit

- Length 24 1/2" / 62cm
- Wingspan 13 1/2" / 34cm
- Flights to over 800' / 240m
- Quality Nose Cone
- High Quality Laser Cut Balsa Fins
- Based on F18 Jet Fighter
- Safe 18" / 46cm parachute recovery  
clear with **red printing** for easy tracking

- Full instructions with 3  
Colour Silkscreen Decal
- Recommended Engines:  
TWO ways to Build:  
B6-2 (first flight), B6-4  
C6-3, C6-5, OR  
D12-3, D12-5, D12-7



One Model Rocket Kit.

Not to any scale.

Recommended for ages 14 and up.

Adult supervision required for children 15-16.

Check local regulations for engine age requirements.

Use only with 1/8" diameter rod for launching.

This model requires assembly.

Glue, epoxy, paint, wadding, engines,

igniters, launch system, and tools not included.

Plastic bags should be always kept away

from babies and children to avoid suffocation.

Contents subject to change



National  
Association  
of Rocketry



8 86649 00001 0

SUNWARD  
DESERTFOX  
SNW00001

[www.sunward1.com](http://www.sunward1.com) [info@sunward1.com](mailto:info@sunward1.com)

© Copyright 2016 Sunward Group Limited.  
All Rights Reserved. Made in Canada.