



About Semroc Astronautics Corporation

Semroc Astronautics Corporation was started by Carl McLawhorn in his college dorm at North Carolina State University in November, 1967. Convincing a small group of investors in his home town of Ayden, North Carolina to invest in a small corporation, the company was re-incorporated as Semroc Astronautics Corporation on December 31, 1969.

Semroc produced a full line of model rocket kits and engines. At its peak, Semroc had twenty-five full time employees working at two facilities. One was for research and development, printing, shipping, and administration. The other was outside town and handled all production and model rocket engine manufacturing. For several years, Semroc was successful selling model rocket kits, supplies, and engines by mail-order and in hobby shops. In early 1971, Semroc became insolvent and had to close its doors.

After 31 years of dreams and preparations, Semroc Astronautics Corporation was reincorporated on April 2, 2002 with a strong commitment to helping put the fun back into model rocketry.

About the Aerobee 150™

The Aerobee 150 was designed by Aerojet General and was first flown in 1955 as an Aerobee-Hi. The Aerobee series was developed to replace the V-2 and WAC Corporal and was an outgrowth of the Navy's Bumblebee project. NASA renamed the Aerobee-Hi to Aerobee 150 in 1959, but they were still essentially the same design. Evolving over the years to a four finned version, the Aerobee 150A, and a two stage version, the Aerobee 300 "Spaerobee", the program was highly successful with over 500 launches.

About Deci-Scale™

Semroc's new line of Deci-Scale™ models includes 1/10 (deci) scale kits of many of the early sounding rockets. The Deci-Scale™ kits are intended to be fun to build, providing the beginning average modeler with all the parts needed to build a reasonably close scale model. An advanced scale modeler will find the included parts are very close to the exact scale that are needed for much closer models.

The Deci-scale™ line was inspired by G. Harry Stine who said, "the best beginner's scale model I've ever found is the Thiokol-NASA I.Q.S.Y Tomahawk." He designed a 1/10 scale model for Centuri Engineering Company that was very popular and sold for many years. As he and others have found, 1/10 scale is almost perfect for many of the favorite rockets and missiles of the early days of space flight.

July 14, 2011, September 21, 2015

Copyright © 2011 Semroc
www.semroc.com

SEMROC

Aerobee 150™

1/10 Semi-Scale
Model

Over 2 Feet Tall

Precision Cut Balsa
Nose Cone

Laser Cut Balsa
Fins

Water Slide
Decal

15" Parachute
Recovery

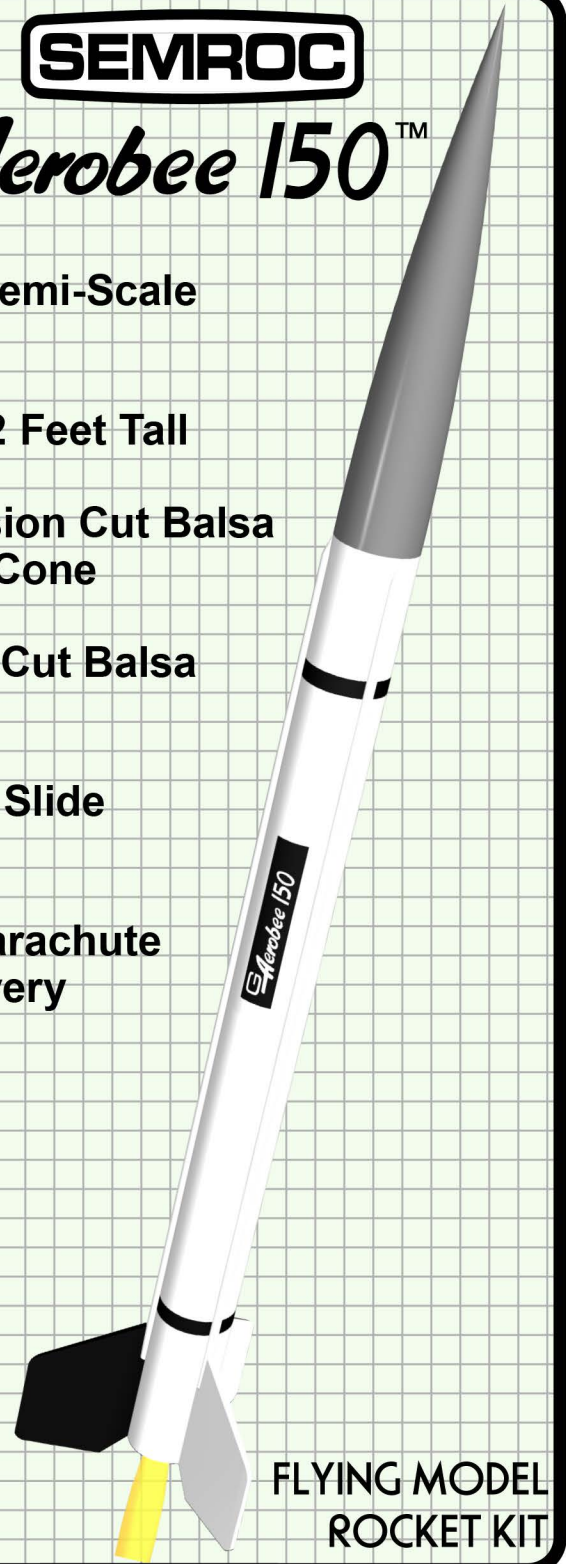

FLYING MODEL
ROCKET KIT

Made in the U.S.A by Semroc—Dayton, Ohio

AEROBEE 150™ Kit No. KD-3

Specifications	Engine	Approx. Altitude
Body Diameter 1.54" (3.9 cm)	D12-5	900'
Length 28.4" (72.1 cm)	E12-6	1500'
Fin Span 6.2" (15.7 cm)		
Net Weight 2.8 oz. (79.4 g)		

Skill Level 2

Parts List

EXPLODED VIEW

- A 1 Balsa Nose Cone... BNC-58AB
- B 1 Body Tube..... BT-58IJ
- C 1 Body Tube..... BT-58AJ
- D 1 Body Tube..... ST-940E
- E 1 Tube Coupler JT-58C
- F 1 Laser Cut Fins FD-3
- G 1 Elastic Cord..... EC-136
- H 1 Engine Hook EH-38
- I 1 Screw Eye SE-10
- J 1 Chute Pak..... CP-12-24
- K 1 Thrust Ring TR-9
- L 1 Launch Lug LL-310
- M 1 Tube Coupler HTC-9
- N 1 Ring Set CR-KD-3
- O 1 Baffle Ring EBR-58
- P 1 Decal DKD-3
- Q 1 Fin Template..... IKD-3T

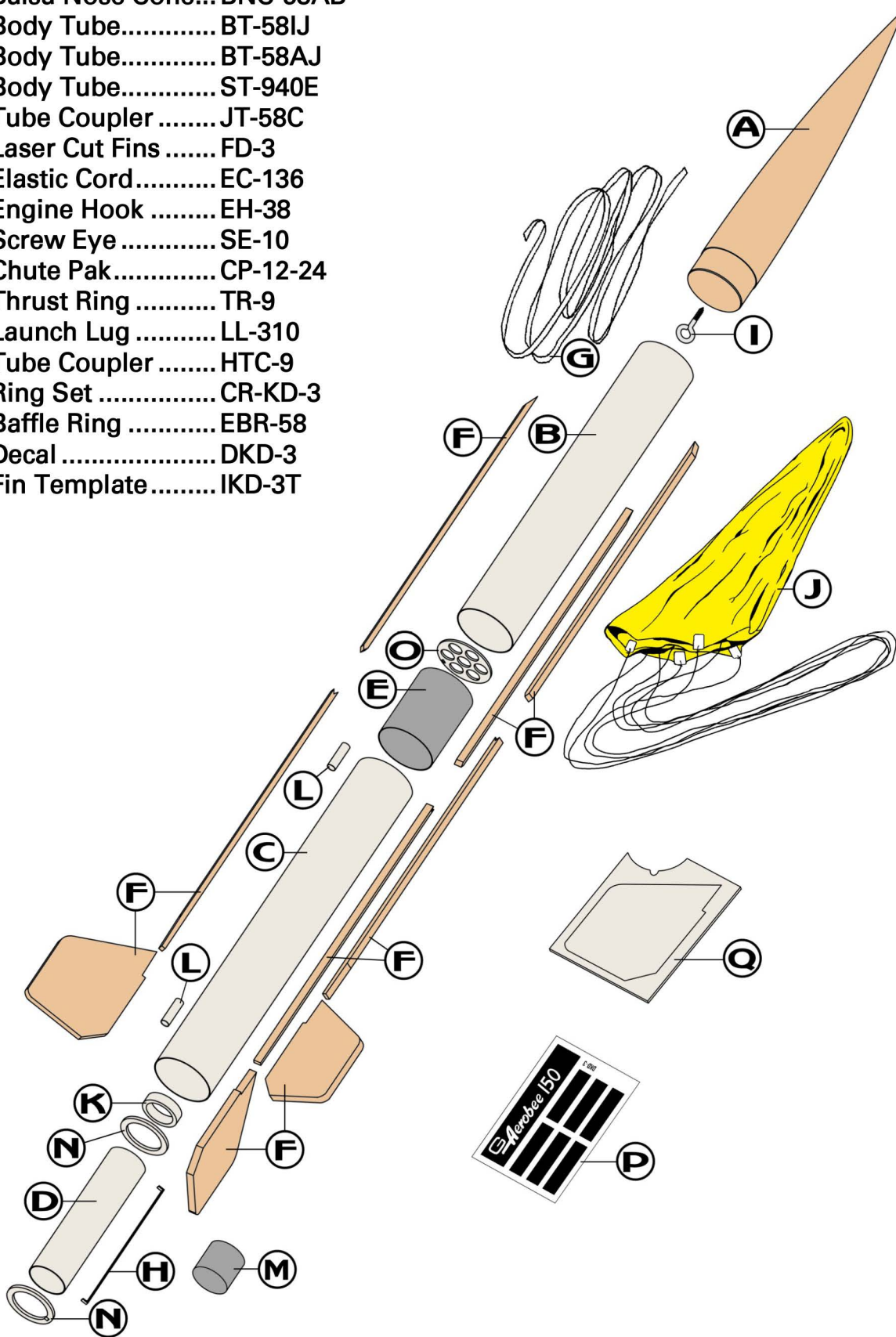

BEFORE YOU START!

Make sure you have all the parts included in this kit that are listed in the Parts List. In addition to the parts included in this kit, you will also need the tools and materials listed below. Read the entire instructions before beginning to assemble your rocket. When you are thoroughly familiar with these instructions, begin construction. Read each step and study the accompanying drawings. Check off each step as it is completed. In each step, test-fit the parts together before applying any glue. It is sometimes necessary to sand lightly or build-up some parts to obtain a precision fit. If you are uncertain of the location of some parts, refer to the exploded view. It is important that you always ensure that you have adequate glue joints.

TOOLS

In addition to the parts supplied, you will need the following tools to assemble and finish this kit. Masking tape and wax paper is also needed.



ASSEMBLY

❑ 1. These instructions are presented in a logical order to help you put your Aerobee 150™ together quickly and efficiently. Check off each step as you complete it and we hope you enjoy putting this kit together.

FIN PREPARATION

❑ 2. Lightly sand each side of the laser-cut balsa sheet (FD-3). Carefully push the laser-cut fins from the sheet. Start at one point on each fin and slowly and gently work around the fin. Since the fin sheet is 3/16" thick, a hobby knife may be needed to cut around some of the fins. The shrouds (conduits) are delicate, so be careful extracting them.

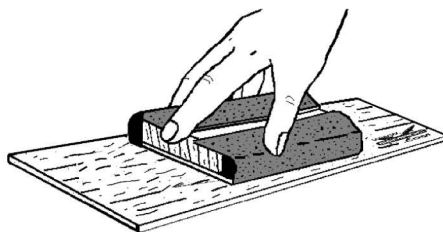

❑ 3. Stack all three main fins in a group. Line the group up squarely and sand the fins back and forth over some fine sandpaper to get rid of the hold-in tabs as shown below.

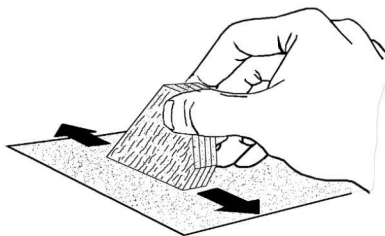

❑ 4. The fins and shrouds (conduits) are the most difficult task. Patience and careful sanding will provide a good scale shape for the fins. Begin by marking the centerline around all the fins. Place a fin inside the template (IKD-3T) as shown and use a felt-tip pen or soft pencil to place the mark. This will be used while sanding to keep the sides symmetrical.

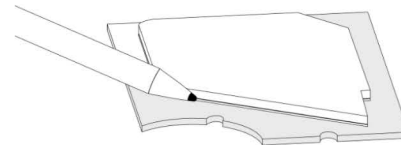

❑ 5. The fin edges are identified below. When finished, all the edges except the root edge will be very thin. The root edge will be bi-convex.

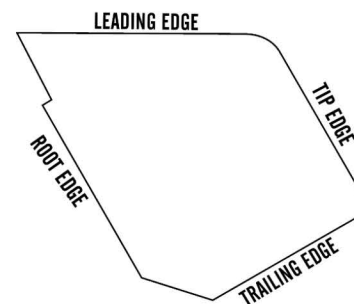

❑ 6. Sand the top and bottom of each fin with a bevel from the root edge to the tip edge. Leave the root edge at its nominal size and sand so the tip is about .05" thick. Use the marks around the fins to get the sides even. After the bevel is completed, sand a convex shape on each side leaving the chord (middle of the fin from root to tip) of each side alone. Refer to the drawings below. Use the centerline drawn as a guide. Fill the thin edges with cyanoacrylate (CA) glue for more strength.

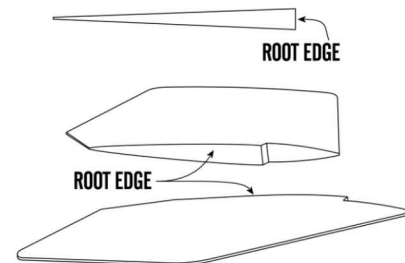

❑ 7. Locate a matching set of shroud pieces. Place them on a sheet of wax paper against a ruler with the triangular joints together. The pointed end should have the flat side up and the flat end has one side slightly beveled that should also be up. Glue the two pieces together. Wipe any excess glue and make sure they

are not glued to the ruler. Repeat with the other two shrouds. Allow all to dry.

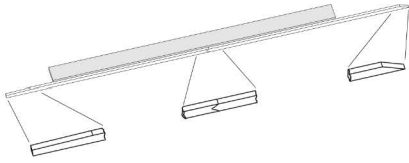

❑ 8. Sand one of the shrouds to a half elliptical cross section. Use the template supplied (IKD-3T) to get the correct shape. The shroud is very delicate until it is glued to the body tube. The sharply beveled end should be sanded to a point. Repeat with the other two shrouds.

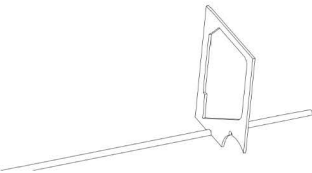

ENGINE MOUNT

❑ 9. Bend the engine hook (EH-38) slightly so it forms a slight bow in the direction shown.



❑ 10. Insert one end of the engine hook (EH-38) into the pre-punched engine tube (ST-940E).

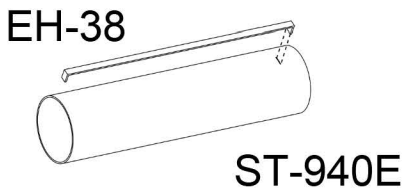

❑ 11. Slide the centering ring (CR-KD-3) with the small slot over the engine tube until it is about 1/2" from the slotted end. Apply a bead of glue around each end of the joint between the ring and engine tube, keeping glue off the outside surface of the centering ring. Allow to dry.

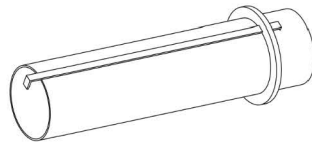

❑ 12. Wrap a strip of masking tape around the center of the engine tube. Apply a film of glue over the masking tape and on the exposed section of the engine hook towards the front. Keep glue off the engine hook near the overhang end.

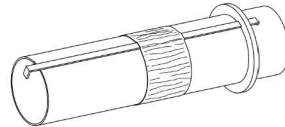

❑ 13. Slide the remaining centering ring (CR-KD-3) over the bottom end of the engine tube with the notch over the engine hook. Space it 1/4" from the bottom of the engine tube. Apply a bead of glue around both sides of the centering ring.

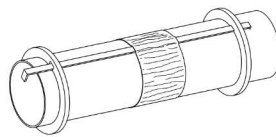

❑ 14. Apply a small bead of glue around the inside of the engine tube nearest the punched end. Slide the thrust ring (TR-9) into the tube and against the engine hook.

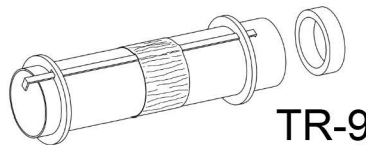

EJECTION BAFFLE

❑ 15. Punch out all the holes from the baffle ring (EBR-58). Insert one end of the elastic shock cord (EC-136) into the small slot near the edge of the ring. Tie a knot in the end and pull it until the knot is against the ring. Apply a generous bead of glue on the knot. Align the ring on one end of

the coupler tube (JT-58C) and glue it in place so the outer edge of the baffle is even with the coupler tube.

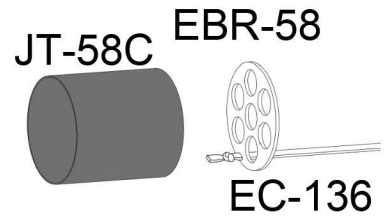

❑ 16. Apply a generous bead of glue inside the coupler tube against the joint between the baffle ring and the coupler tube. Glue the end of the elastic cord to the coupler tube.

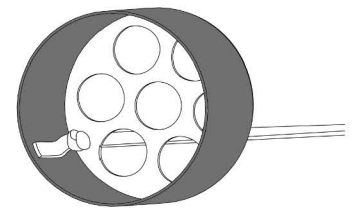

❑ 17. Test fit the ejection baffle in the shortest (9") large body tube (BT-58IJ). Feed the free end of the elastic cord through the tube and out the top. Apply a bead of glue just inside the body tube and insert the baffle halfway into the tube, leaving the bottom half of the baffle exposed. Keep the elastic cord away from the glue as much as possible.

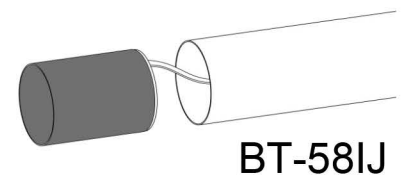

❑ 18. Before the glue has completely dried, apply a bead of glue in one end of the remaining large body tube (BT-58AJ) and insert the exposed end of the baffle into the tube. Roll the assembly on a clear flat surface to make sure the body tubes are aligned. Continue rolling until the glue sets.

BT-58AJ

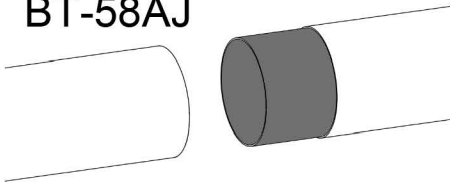

MARK TUBE

□ 19. Stand the body tube assembly on the fin guide below and make the fin position marks on the sides of the tube. Find a convenient channel or groove such as a partially open drawer, a door jamb (as shown,) or a piece of molding. Using the channel, extend the marks the full length of the tube to provide lines for aligning the fins.

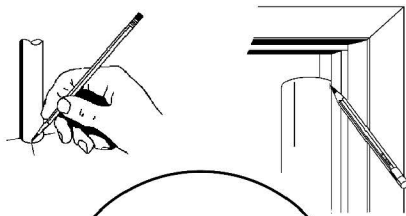

BT-58
FIN GUIDE

GLUE MOUNT

□ 20. Check the engine mount for fit in the lower body tube (opposite the elastic cord.) If it has rough edges or excessive glue, sand lightly until it fits into the body tube. Apply a heavy bead around the inside of the body tube. Quickly and smoothly push the engine mount into the marked end of the body tube until about 1/8" is extending from the body tube and the **engine hook is centered between two of the lines drawn on the body tube.** Do not stop once you start inserting the mount or it might freeze in place too soon. Apply a fillet of glue around the bottom ring against the main body tube.

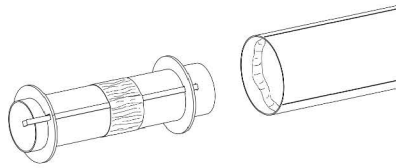

ATTACH FINS

□ 21. Apply glue to the root edge of one of the fins and position it along one of the lines drawn on the side of the body tube and even with the end of the tube. Remove, allow to almost dry, apply additional glue, and reposition. Repeat for the other two fins. Allow to dry in an upright position, checking frequently to make sure they remain aligned.

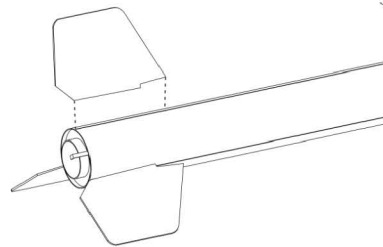

□ 22. Apply glue to the root edge of one of the shrouds and position it along one of the lines drawn on the side of the body tube and with the slightly beveled end under the notch in the main fin. Repeat for the other two shrouds. Allow to dry in an upright position, checking frequently to make sure they remain aligned.

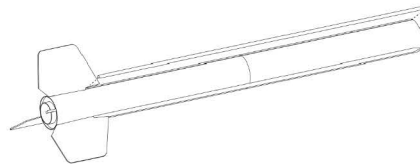

□ 23. After the fin assembly is completely dry, run a very small bead of glue along both sides of each fin-body tube joint. Using your forefinger, smooth the glue into fillets. Since this is a scale model, it should not have fillets showing. Wipe any excess glue and allow to dry.

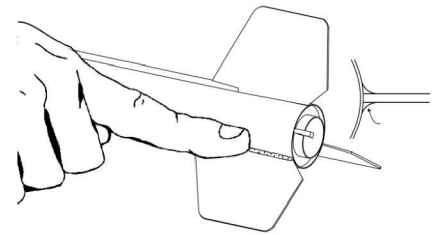

LAUNCH LUG

□ 24. Cut the Launch Lug (LL-310) into two 1/2" pieces. Glue one of the launch lugs between two of the fins and even with the bottom of the tube. Glue the second launch lug about 6" from the bottom of the tube and in line with the first launch lug. Sight down the tube to make sure they are aligned.

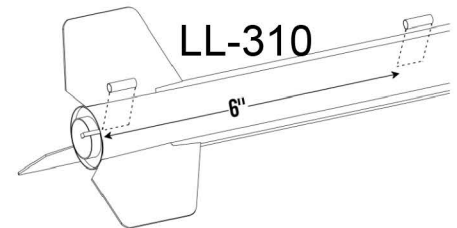

NOSE CONE

□ 25. Insert the nose cone (BNC-58AB) in the top of the body tube and check for proper fit. The nose cone should be snug to hold itself in alignment. If it is too loose, add some masking tape. If it is too tight, sand the shoulder slightly.

□ 26. Twist the screw eye (SE-10) into the center of the base of the nose cone. Remove it and squirt a drop of glue into the hole. Reinsert the screw eye and run a bead of glue around the shaft against the nose cone.

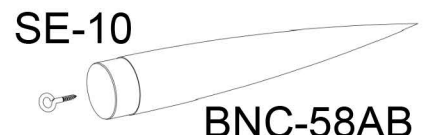

FINAL ASSEMBLY

❑ 27. Assemble the 15" chute (CP-12-24) using the instructions that come with the Chute Pak. Pull the lines tight on the chute and make sure they are all of equal length. Attach the chute by tying them to the screw eye. Put a drop of glue on the joint to keep the lines from moving. Shake the elastic cord free and out of the top of the main tube. Attach the free end of the elastic cord to the screw eye. Put a drop of glue on that joint as well.

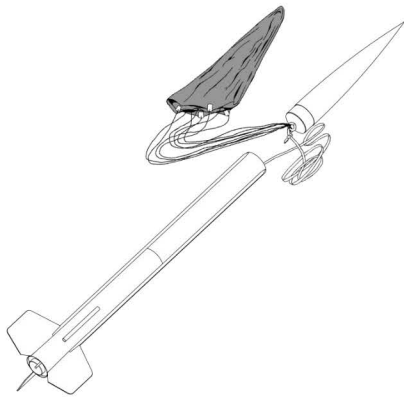

FINISHING

❑ 28. For a smooth professional looking finish, fill the wood grain with balsa fillercoat or sanding sealer. When dry, sand with fine sandpaper. Repeat until smooth.

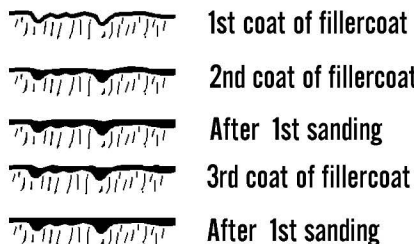

❑ 29. After all balsa surfaces have been prepared, wipe off all balsa dust with a dry cloth. First spray the model with an enamel primer. Choose a high visibility color like white for the final color. Refer to the front for suggested (scale) painting.

❑ 30. Spray painting your model with a fast-drying enamel will produce the best results. PATIENCE...is the most important ingredient. Use several thin coats, allowing each coat to completely dry before the next coat. Start each spray a few inches above the model and end a few inches below the model. Keep the can about 12" away and use quick light coats. The final coat can be a little heavier to give the model a glossy wet-looking finish.

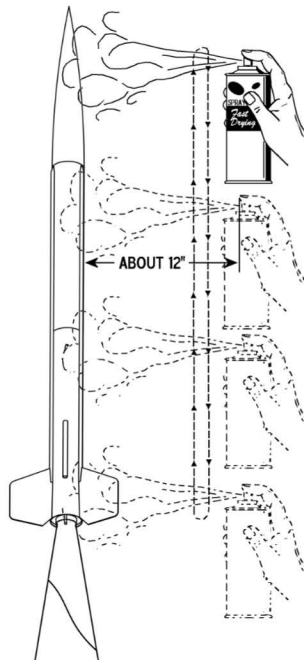

❑ 31. After the paint has dried, decals should be applied. The decals supplied with the Aerobee 150™ are waterslide decals. Each decal should be cut separately from the sheet. Think about where you want to apply each decal and check for fit before wetting the decal. Use the cover photo for suggested placement. Dip each decal in a small dish of water that has a drop of detergent. It will take about 30 seconds before the decal is loose enough to apply.



FLIGHT PREPPING

❑ 32. Mounting the engine: Insert the engine and make sure the engine hook keeps the engine in snugly. The hook may be slightly bent to make sure the engine is retained.

❑ 33. Apply a few sheets of recovery wadding in the top of the body tube. Fold the parachute and pack it and the shock cord on top of the recovery wadding. Slide the nose cone into place, making sure it does not pinch the shock cord or parachute.

❑ 34. Refer to the model rocket engine manufacturer's instructions to complete the engine prepping. Different engines have different igniters and methods of hooking them up to the launch controllers.

❑ 35. Carefully check all parts of your rocket before each flight as a part of your pre-flight checklist. Launch the Aerobee 150™ from a 1/8" diameter by 36" long launch rod.

❑ 36. After each flight, promptly remove the spent engine casing and dispose of properly.

SEMROC

Aerobee 150™

1/10 Semi-Scale
Model

Over 2 Feet Tall

Precision Cut Balsa
Nose Cone

Laser Cut Balsa
Fins

Water Slide
Decal

15" Parachute
Recovery



FLYING MODEL
ROCKET KIT

Made in the U.S.A. by Semroc-Daguer, N.H.

AEROBEE 150™

Kit No. KD-3

Specifications		Engine	Approx. Altitude
Body Diameter	1 3/4" (38 mm)	E10-C	500'
Length	25 1/2" (651 mm)	E12-B	1500'
Fin Span	6 1/2" (165 mm)		
Net Weight	2.8 oz. (79.4 g)		

Skill Level 2